

PRICE LIST 2023



AUTOMATION BRAND



SWITCHGEAR BRAND



We touch your **electricity** everyday!

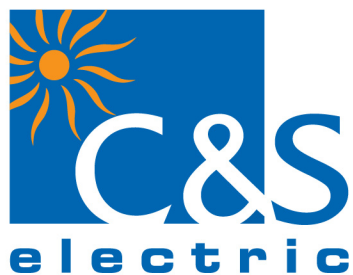

PRICE LIST

w.e.f 7th July, 2023

LV Components & Solutions

WHAT'S NEW

Air Circuit
Breakers

WiNmaster 3
Air Circuit Breaker



Page No. 6

Motor
Protection
Circuit Breaker

exceed



Page No. 62

Automatic
Transfer
Switch
CATS



Page No. 55

Lighting Trunking
LB Series



Page No. 59

Modular
Switches

elusio
SWITCHES



Page No. 136



CONTENTS

Power Distribution Components	
WiNmaster3 ACB	6 ~ 10
WiNmaster2 ACB	11 ~ 14
AH/AHA ACB	15 ~ 27
WiNbreak1 MCCB	28 ~ 34
WiNbreak2 MCCB	35 ~ 39
WiNbreak MCCB - CS Series	40
WiNbreak MCCB - CSC Series	41 ~ 43
Switch Disconnecter Fuse Unit	44 ~ 46
Switch Disconnecter	47 ~ 49
Changeover Switch	50 ~ 51
Bypass Switch	52 ~ 53
SDF Changeover	54
Automatic Transfer Switch	55-56
Fusegear	57 ~ 58
Lighting Trunking	59 ~ 60
Power Control Components	
Motor Protection Circuit Breaker (MPCB)	62 ~ 67
robusTa2 Contactor & Overload Relay	68-69
Powe Contactor DX-Series	70
Mini Contactor	71~72
Exceed Contactor	73 ~ 74
robusTa Power Contactor	75 ~ 78
Capacitor Duty Contactor	79
robusTa Overload Relay	80
Accessories - robusTa & Exceed Contactor	81 ~ 84
D Range Contactor, Overload Relay & Accessories	85 ~ 87
4 Pole & 2 Pole Contactor & Overload Relay, Definite Purpose Contactor	88 ~ 90
Industrial Plug & Socket	92
Control & Signalling Device	93-101
Motor Starters	102-108
Protection, Measurement & Control Devices	
Digital Panel Meter	110
Multi Function Meter	110
Power Factor Controller	110
Electronic Motor Protection Relay	111-113
Electronic Motor Protection Relay-CSMP	114
ELR - Earth Leakage Relay	115
DG AMF / Synchronizing Controller	116
Voltage & Current Monitoring Relay & Timer	116
Final Power Distribution Components	
Miniature Circuit Breaker, Isolator & MCB Type Changeover Switch	117 ~ 125
Residual Current Circuit Breaker	126 ~ 127
ACCL	128
Distribution Board	129 ~ 134
Plug & Socket DB	135
Wiring Accessories	
Modular Switches - ELUSIO	136 ~ 138
Modular Switches - DIVINO	140 ~ 143
Weather Proof Enclosure - COMBI	144
Accessories	145
Modular Switches - PRIMO Plus	146 ~ 150
Modular Switches - PRIMO	151 ~ 154
Central Customer Care (CCC)	155



General Terms & Conditions

Maximum Retail Price are subject to revision without prior notice and will be applicable as prevailing at the time of dispatch.

- This Price List supercedes all previous Price Lists.
- All prices are on Maximum Retail Price basis inclusive of all Duties, GST and any other Tax as applicable.
- All Prices are in Indian Rupees.

Warranty

All our listed products carry a warranty, against manufacturing defects for a period of 12 months from the date of invoicing subject to it's usages in normal recommended operating conditions. The company liability shall be limited to exchange or repair of the product, at its discretion, provided that such defective products are returned to billing address with all necessary documents.

CENTRAL CUSTOMER CARE (CCC)

Single stop Customer Support for all service needs, please contact:

Toll Free Number: 1800 572 2012

E-mail: customercare@cselectric.co.in

POR - Price on request

Products have been classified as Stockable & Non Stockable items.

Non Stockable items has been marked as 

HSN Code denoted as below:

[HSN Code 8536] GST@18%*

[HSN Code 8537] GST@18%*

[HSN Code 8538] GST@18%*

*Subject to change as per Government of India notification



Power Distribution Components



- Air Circuit Breakers
- Moulded Case Circuit Breakers
- Switch Disconnecter Fuses
- Switch Disconnectors
- Changeover & Bypass Switches
- Automatic Transfer Switches
- HRC Fuse Links, Fuse Bases & Fuse Holders



Efficient Partner in Power Distribution & Protection



WiNmaster 3

Air Circuit Breaker

- Rated Operational Voltage upto 800V
- Breaking Capacity upto 100kA
- **Optimized Size** - Uniform Height & Depth across the Frame
- **Quick** - Fastest Opening & Closing Time
- **Truly Modular** - Front Accessible Accessories & SIC
- **Universal Termination** - Terminal orientation convertible as Horizontal / Vertical on site
- No Derating upto 50°C
- Intelligent Micropro3 Release Family
- Multiple Parameter Measurement
- **Condition Monitoring** - Contact Wear Indication, 20 Trip History

We touch your **electricity** everyday!

Micropro3 Series

- LSIG ; Neutral & Advance Protection
- MCR & HSISC Protection
- Thermal Memory for LT & ST
- LCD Display
- Self Diagnostics in Test Mode
- Modbus Protocol, ZSI and Breaker Failure Protection
- Contact wear Indication, Total no of operations, & operating time
- ACB ID assignment
- Bar Representation for Input Current and Voltage on Home Screen



Winmaster3 Air Circuit Breakers - Operational Voltage upto 690V

- Range 630A to 4000A
- ACB with Universal Termination*
- Microprocessor release with Individual Fault Annunciation LEDs

Price on Request

[HSN Code: 8536]

3 Pole MDO Winmaster3 Air Circuit Breakers with Micropro3- 3.1 Release with LSING Protection, Icu=Ics				
Rating (Amps)	N (50kA @ 415V AC)	S (65kA @ 415V AC)	L (80kA @ 415V AC)	H (100kA @ 415V AC)
630A	WX306N3P1MDOA(S)	WX306S3P1MDOA(S)	WX306L3P1MDOA(S)	WX306H3P2MDOA(S)
800A	WX308N3P1MDOA(S)	WX308S3P1MDOA(S)	WX308L3P1MDOA(S)	WX308H3P2MDOA(S)
1000A	WX310N3P1MDOA(S)	WX310S3P1MDOA(S)	WX310L3P1MDOA(S)	WX310H3P2MDOA(S)
1250A	WX312N3P1MDOA(S)	WX312S3P1MDOA(S)	WX312L3P1MDOA(S)	WX312H3P2MDOA(S)
1600A	WX316N3P1MDOA(S)	WX316S3P1MDOA(S)	WX316L3P1MDOA(S)	WX316H3P2MDOA(S)
2000A	WX320N3P1MDOA(S)	WX320S3P1MDOA(S)	WX320L3P1MDOA(S)	WX320H3P2MDOA(S)
2500A	WX325N3P1MDOA(S)	WX325S3P1MDOA(S)	WX325L3P1MDOA(S)	WX325H3P2MDOA(S)
3200A	-	-	-	WX332H3P2MDOA(S)
4000A	-	-	-	WX340H3P2MDOA(S)

4 Pole MDO Winmaster3 Air Circuit Breakers with Micropro3- 3.1 Release with LSING Protection, Icu=Ics				
Rating (Amps)	N (50kA @ 415V AC)	S (65kA @ 415V AC)	L (80kA @ 415V AC)	H (100kA @ 415V AC)
630A	WX306N4P1MDOA(S)	WX306S4P1MDOA(S)	WX306L4P1MDOA(S)	WX306H4P2MDOA(S)
800A	WX308N4P1MDOA(S)	WX308S4P1MDOA(S)	WX308L4P1MDOA(S)	WX308H4P2MDOA(S)
1000A	WX310N4P1MDOA(S)	WX310S4P1MDOA(S)	WX310L4P1MDOA(S)	WX310H4P2MDOA(S)
1250A	WX312N4P1MDOA(S)	WX312S4P1MDOA(S)	WX312L4P1MDOA(S)	WX312H4P2MDOA(S)
1600A	WX316N4P1MDOA(S)	WX316S4P1MDOA(S)	WX316L4P1MDOA(S)	WX316H4P2MDOA(S)
2000A	WX320N4P1MDOA(S)	WX320S4P1MDOA(S)	WX320L4P1MDOA(S)	WX320H4P2MDOA(S)
2500A	WX325N4P1MDOA(S)	WX325S4P1MDOA(S)	WX325L4P1MDOA(S)	WX325H4P2MDOA(S)
3200A	-	-	-	WX332H4P2MDOA(S)
4000A	-	-	-	WX340H4P2MDOA(S)

3 Pole MF Winmaster3 Air Circuit Breakers with Micropro3- 3.1 Release with LSING Protection, Icu=Ics				
Rating (Amps)	N (50kA @ 415V AC)	S (65kA @ 415V AC)	L (80kA @ 415V AC)	H (100kA @ 415V AC)
630A	WX306N3P1MFA(S)	WX306S3P1MFA(S)	WX306L3P1MFA(S)	WX306H3P2MFA(S)
800A	WX308N3P1MFA(S)	WX308S3P1MFA(S)	WX308L3P1MFA(S)	WX308H3P2MFA(S)
1000A	WX310N3P1MFA(S)	WX310S3P1MFA(S)	WX310L3P1MFA(S)	WX310H3P2MFA(S)
1250A	WX312N3P1MFA(S)	WX312S3P1MFA(S)	WX312L3P1MFA(S)	WX312H3P2MFA(S)
1600A	WX316N3P1MFA(S)	WX316S3P1MFA(S)	WX316L3P1MFA(S)	WX316H3P2MFA(S)
2000A	WX320N3P1MFA(S)	WX320S3P1MFA(S)	WX320L3P1MFA(S)	WX320H3P2MFA(S)
2500A	WX325N3P1MFA(S)	WX325S3P1MFA(S)	WX325L3P1MFA(S)	WX325H3P2MFA(S)
3200A	-	-	-	WX332H3P2MFA(S)
4000A	-	-	-	WX340H3P2MFA(S)

4 Pole MF Winmaster3 Air Circuit Breakers with Micropro3- 3.1 Release with LSING Protection, Icu=Ics				
Rating (Amps)	N (50kA @ 415V AC)	S (65kA @ 415V AC)	L (80kA @ 415V AC)	H (100kA @ 415V AC)
630A	WX306N4P1MFA(S)	WX306S4P1MFA(S)	WX306L4P1MFA(S)	WX306H4P2MFA(S)
800A	WX308N4P1MFA(S)	WX308S4P1MFA(S)	WX308L4P1MFA(S)	WX308H4P2MFA(S)
1000A	WX310N4P1MFA(S)	WX310S4P1MFA(S)	WX310L4P1MFA(S)	WX310H4P2MFA(S)
1250A	WX312N4P1MFA(S)	WX312S4P1MFA(S)	WX312L4P1MFA(S)	WX312H4P2MFA(S)
1600A	WX316N4P1MFA(S)	WX316S4P1MFA(S)	WX316L4P1MFA(S)	WX316H4P2MFA(S)
2000A	WX320N4P1MFA(S)	WX320S4P1MFA(S)	WX320L4P1MFA(S)	WX320H4P2MFA(S)
2500A	WX325N4P1MFA(S)	WX325S4P1MFA(S)	WX325L4P1MFA(S)	WX325H4P2MFA(S)
3200A	-	-	-	WX332H4P2MFA(S)
4000A	-	-	-	WX340H4P2MFA(S)

Note: * Universal termination option available upto 3200A



Air Circuit Breaker

Winmaster3 Air Circuit Breakers - Operational Voltage 800V

- Range 630A to 4000A
- ACB with Universal Termination*
- Microprocessor release with Individual Fault Annunciation LEDs

Price on Request

[HSN Code: 8536]

3 Pole MDO Winmaster3 Air Circuit Breakers with Micropro3- 3.1 Release with LSING Protection, Icu=Ics		
Rating (Amps)	MC (42kA @ 800V AC)	NC (50kA @ 800V AC)
630A	WX306MC3P1MDOA(S)	WX306NC3P2MDOA(S)
800A	WX308MC3P1MDOA(S)	WX308NC3P2MDOA(S)
1000A	WX310MC3P1MDOA(S)	WX310NC3P2MDOA(S)
1250A	WX312MC3P1MDOA(S)	WX312NC3P2MDOA(S)
1600A	WX316MC3P1MDOA(S)	WX316NC3P2MDOA(S)
2000A	WX320MC3P1MDOA(S)	WX320NC3P2MDOA(S)
2500A	WX325MC3P1MDOA(S)	WX325NC3P2MDOA(S)
3200A	-	WX332NC3P2MDOA(S)
4000A	-	WX340NC3P2MDOA(S)

4 Pole MDO Winmaster3 Air Circuit Breakers with Micropro3- 3.1 Release with LSING Protection, Icu=Ics		
Rating (Amps)	MC (42kA @ 800V AC)	NC (50kA @ 800V AC)
630A	WX306MC4P1MDOA(S)	WX306NC4P2MDOA(S)
800A	WX308MC4P1MDOA(S)	WX308NC4P2MDOA(S)
1000A	WX310MC4P1MDOA(S)	WX310NC4P2MDOA(S)
1250A	WX312MC4P1MDOA(S)	WX312NC4P2MDOA(S)
1600A	WX316MC4P1MDOA(S)	WX316NC4P2MDOA(S)
2000A	WX320MC4P1MDOA(S)	WX320NC4P2MDOA(S)
2500A	WX325MC4P1MDOA(S)	WX325NC4P2MDOA(S)
3200A	-	WX332NC4P2MDOA(S)
4000A	-	WX340NC4P2MDOA(S)

3 Pole MF Winmaster3 Air Circuit Breakers with Micropro3- 3.1 Release with LSING Protection, Icu=Ics		
Rating (Amps)	MC (42kA @ 800V AC)	NC (50kA @ 800V AC)
630A	WX306MC3P1MFA(S)	WX306NC3P2MFA(S)
800A	WX308MC3P1MFA(S)	WX308NC3P2MFA(S)
1000A	WX310MC3P1MFA(S)	WX310NC3P2MFA(S)
1250A	WX312MC3P1MFA(S)	WX312NC3P2MFA(S)
1600A	WX316MC3P1MFA(S)	WX316NC3P2MFA(S)
2000A	WX320MC3P1MFA(S)	WX320NC3P2MFA(S)
2500A	WX325MC3P1MFA(S)	WX325NC3P2MFA(S)
3200A	-	WX332NC3P2MFA(S)
4000A	-	WX340NC3P2MFA(S)

4 Pole MF Winmaster3 Air Circuit Breakers with Micropro3- 3.1 Release with LSING Protection, Icu=Ics		
Rating (Amps)	MC (42kA @ 800V AC)	NC (50kA @ 800V AC)
630A	WX306MC4P1MFA(S)	WX306NC4P2MFA(S)
800A	WX308MC4P1MFA(S)	WX308NC4P2MFA(S)
1000A	WX310MC4P1MFA(S)	WX310NC4P2MFA(S)
1250A	WX312MC4P1MFA(S)	WX312NC4P2MFA(S)
1600A	WX316MC4P1MFA(S)	WX316NC4P2MFA(S)
2000A	WX320MC4P1MFA(S)	WX320NC4P2MFA(S)
2500A	WX325MC4P1MFA(S)	WX325NC4P2MFA(S)
3200A	-	WX332NC4P2MFA(S)
4000A	-	WX340NC4P2MFA(S)

MRP & Reference Code changes as per the release modification	Ordering Code	MRP (₹)
Without release ACB	WR	POR
MicroPro3 3.1 (LSING)	A	
MicroPro3 4.1 (LSING, LED Display, Current Measurement, Trip History)	B	
MicroPro3 5.1 (LSING, 2 LED Display, Current + Voltage + Power Measurement, Trip History, ZSI, Communication, Maintenance Indicator)	D	

Note: For Winmaster3 MRP please connect with nearest branch office

ACB Winmaster3 - Ordering Information

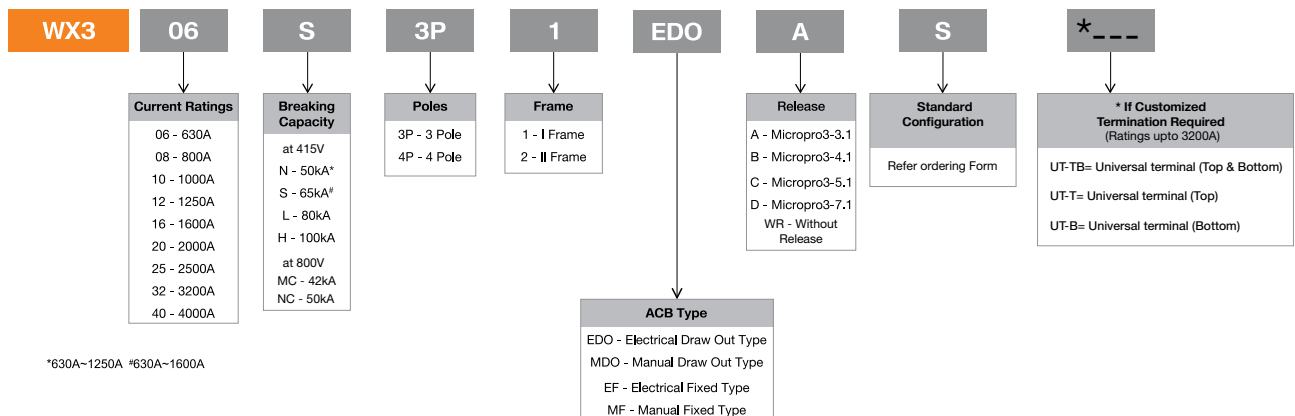



Winmaster3 ACB Order Form

Please fill separate sheet for each type of ACB, Tick the box in front of each appropriate item and fill in the blanks.

Customer Name	Order No. & Date	Delivery Date	End User/ Panel Builder Name & Ph. No.

Frame1 ACB	<input type="checkbox"/> 630A <input type="checkbox"/> 1000A <input type="checkbox"/> 1600A <input type="checkbox"/> 2500A <input type="checkbox"/> 800A <input type="checkbox"/> 1250A <input type="checkbox"/> 2000A				Product Code
	Breaking Capacity	630A ~1250A <input type="checkbox"/> 50kA 415V <input type="checkbox"/> 36kA 690V	630A ~1600A <input type="checkbox"/> 65kA 415V <input type="checkbox"/> 42kA 690V	630A ~2500A <input type="checkbox"/> 80kA 415V <input type="checkbox"/> 50kA 690V <input type="checkbox"/> 42kA 800V	

Frame2 ACB	<input type="checkbox"/> 800A <input type="checkbox"/> 1250A <input type="checkbox"/> 2000A <input type="checkbox"/> 3200A <input type="checkbox"/> 1000A <input type="checkbox"/> 1600A <input type="checkbox"/> 2500A <input type="checkbox"/> 4000A				Qty.
	Breaking Capacity	<input type="checkbox"/> 100kA, 415V AC <input type="checkbox"/> 65kA, 690V AC <input type="checkbox"/> 50kA, 800V AC			

Variant	<input type="checkbox"/> 3 Pole <input type="checkbox"/> 4 Pole <input type="checkbox"/> Manual <input type="checkbox"/> Electrical <input type="checkbox"/> Fixed <input type="checkbox"/> Drawout
----------------	-----------------------------------------------------------------------------------------------------------------------------------------------------------------------------------------------------

Standard Configuration	Manual Fixed (MF)	Electrical Fixed (EF)	Manual Drawn Out (MDO)	Electrical Drawn Out (EDO)
	Microprocessor Release	Microprocessor Release	Microprocessor Release	Microprocessor Release
	60 Ways SIC (6NO+6NC available on site)	60 Ways SIC (6NO+6NC available on site)	60 Ways SIC (6NO+6NC available on site)	60 Ways SIC (6NO+6NC available on site)
		Charging Motor		Charging Motor
		Shunt Release		Shunt Release
		Closing Coil		Closing Coil
	RTC & Spring charge indication		RTC & Spring charge indication	

Customized Termination - 630A to 3200A

Top Universal Termination Phase Barriers
 Bottom Universal Terminal (Mandatory in case of Horizontal orientation of terminal / busbar)
 Top Flat Terminal
 Bottom Flat Terminal

Note: In case of customized termination please confirm for Top and Bottom

Closing Coil	Charging Motor															
<table border="1" style="width:100%; border-collapse: collapse;"> <tr><td>110V AC/DC</td><td>220V AC/DC</td><td>415V AC</td></tr> <tr><td>24V DC</td><td>48V DC</td><td></td></tr> </table>	110V AC/DC	220V AC/DC	415V AC	24V DC	48V DC		<table border="1" style="width:100%; border-collapse: collapse;"> <tr><td>110V AC/DC</td><td>220V AC/DC</td><td>415V AC</td></tr> </table>	110V AC/DC	220V AC/DC	415V AC						
110V AC/DC	220V AC/DC	415V AC														
24V DC	48V DC															
110V AC/DC	220V AC/DC	415V AC														
Shunt Trip Coil	UVT															
<table border="1" style="width:100%; border-collapse: collapse;"> <tr><td>110V AC/DC</td><td>220V AC/DC</td><td>415V AC</td></tr> <tr><td>24V DC</td><td>48V DC</td><td></td></tr> </table>	110V AC/DC	220V AC/DC	415V AC	24V DC	48V DC		<table border="1" style="width:100%; border-collapse: collapse;"> <tr><td>100-130V AC</td><td>220-250V AC</td><td>380-440V AC</td></tr> <tr><td>110V DC</td><td>220V DC</td><td></td></tr> <tr><td colspan="2">Without Time Delay</td><td>With Time Delay</td></tr> </table>	100-130V AC	220-250V AC	380-440V AC	110V DC	220V DC		Without Time Delay		With Time Delay
110V AC/DC	220V AC/DC	415V AC														
24V DC	48V DC															
100-130V AC	220-250V AC	380-440V AC														
110V DC	220V DC															
Without Time Delay		With Time Delay														

Release	<input type="checkbox"/> MicroPro3-3.1 <input type="checkbox"/> MicroPro3-4.1 <input type="checkbox"/> MicroPro3-5.1 <input type="checkbox"/> MicroPro3-7.1 <input type="checkbox"/> Without Release
PSM (Control Voltage)	<input type="checkbox"/> 220V AC <input type="checkbox"/> 220V DC <input type="checkbox"/> 415V AC <input type="checkbox"/> 24V DC

Door Interlock Mechanical Interlock Cable Type Rating Preventor
 Key Interlock Electrical Position Indication Mechanical Counter
 1 ACB 2 ACB 3 ACB IP 54 Protection (For Drawout ACB Only)
 Spring charge Ind.(Elec. Only)

Special Requirement if any

Notes:
 (1) Please refer to catalogue / Price list for further details of MicroPro3 release
 (2) Neutral CT is required along with Micropro3 release in case ground fault protection is required with 3P ACB and needs to be connected with solid Neutral Link.
 (3) Trip indication switch shall be available by default with ACB equipped with microprocessor release.



WiNmaster2

Breaker with intelligence

WiNmaster2 Power Circuit Breakers are a new generation of Air Circuit Breakers having modular construction to offer a truly global product platform meeting IEC, ANSI and UL standards.



Range
630A~2500A

Single frame
for
complete
range

Poles
3P & 4P

Versions
Fixed & Drawout
(Mechanical
& Electrical)

$I_{cs}=I_{cu}=I_{cw}$
(for 1 sec)
at 50kA

CE **RoHS**
Compliant

Intelligent releases

- Micropro2 3.1
- Micropro2 4.1
- Micropro2 7.1

Measurement

Trip
History

ZSI

Fault
LED retention

Short Circuit
Protection

Communication





Air Circuit Breaker

Winmaster2 Air Circuit Breaker

630A-2500A

Features:

- LSING Protection
- Digital Display
- Communication through RS 485 Port
- True RMS Sensing
- Current, Voltage, Power Measurement with Maximeter
- Thermal Memory
- Trip History
- Fault Indication
- Zone Selectivity
- Harmonics



Winmaster2 Breakers fitted with standard accessories, tabulated below, are included in the Prices mentioned in subsequent tables.

Manual Fixed (MF)	Electrical Fixed (EF)	Manual Drawout (MDO)	Electrical Drawout (EDO)
<ul style="list-style-type: none"> - Microprocessor Release - Auxiliary Switch 6NO+6NC - Main CTs - Terminal Type - Horizontal 	<ul style="list-style-type: none"> - Microprocessor Release - Auxiliary Switch 6NO+6NC - Main CTs - AC/DC Charging Motor - Closing Coil - Shunt Trip - Terminal Type - Horizontal 	<ul style="list-style-type: none"> - Microprocessor Release - Auxiliary Switch 6NO+6NC - Main CTs - Safety Shutter - 60 Way auxiliary isolating contacts - Terminal Type - Horizontal 	<ul style="list-style-type: none"> - Microprocessor Release - Auxiliary Switch 6NO+6NC - Main CTs - Safety Shutter - 60 Way auxiliary isolating contacts - AC/DC Charging Motor - Closing Coil - Shunt Trip - Terminal Type - Horizontal

Air Circuit Breaker with Intelligent Release Micropro2-3.1

Fixed 3 Pole		[HSN Code: 8536]		
Rating (Amps)	Breaking Capacity Icu=Ics=Icw (1sec)	Reference	MRP (₹)	
			*MF	*EF
630	50kA	WX06N3P*A(S)	177640	237720
800	50kA	WX08N3P*A(S)	177640	237720
1000	50kA	WX10N3P*A(S)	187010	249560
1250	50kA	WX12N3P*A(S)	217020	280440
1600	50kA	WX16N3P*A(S)	243220	304550
2000	50kA	WX20N3P*A(S)	285650	346410
2500	50kA	WX25N3P*A(S)	319940	393270

Air Circuit Breaker with Intelligent Release Micropro2-3.1

Fixed 4 Pole		[HSN Code: 8536]		
Rating (Amps)	Breaking Capacity Icu=Ics=Icw (1sec)	Reference	MRP (₹)	
			*MF	*EF
630	50kA	WX06N4P*A(S)	223710	282750
800	50kA	WX08N4P*A(S)	223710	282750
1000	50kA	WX10N4P*A(S)	233610	293180
1250	50kA	WX12N4P*A(S)	273760	335080
1600	50kA	WX16N4P*A(S)	311400	372140
2000	50kA	WX20N4P*A(S)	373340	438240
2500	50kA	WX25N4P*A(S)	395730	460160

Drawout 3 Pole		[HSN Code: 8536]		
Rating (Amps)	Breaking Capacity Icu=Ics=Icw (1sec)	Reference	MRP (₹)	
			*MDO	*EDO
630	50kA	WX06N3P*A(S)	247130	300500
800	50kA	WX08N3P*A(S)	247130	300500
1000	50kA	WX10N3P*A(S)	257250	312530
1250	50kA	WX12N3P*A(S)	278390	340880
1600	50kA	WX16N3P*A(S)	319370	378900
2000	50kA	WX20N3P*A(S)	390350	452830
2500	50kA	WX25N3P*A(S)	478070	545070

Drawout 4 Pole		[HSN Code: 8536]		
Rating (Amps)	Breaking Capacity Icu=Ics=Icw (1sec)	Reference	MRP (₹)	
			*MDO	*EDO
630	50kA	WX06N4P*A(S)	293250	354470
800	50kA	WX08N4P*A(S)	293250	357850
1000	50kA	WX10N4P*A(S)	310040	371970
1250	50kA	WX12N4P*A(S)	330450	409120
1600	50kA	WX16N4P*A(S)	382460	444390
2000	50kA	WX20N4P*A(S)	470420	531740
2500	50kA	WX25N4P*A(S)	559000	618580

List Price & Reference Code changes for ACB with Neutral CT

For ACB with NCT add to the above price of 3 Pole ACB with MP2 3.1		ADD	9430
With NCT ordering Code will be	Existing Code	New Code	
	WX06N3PMFA(S)	WX06N3PNMFA(S)	
	WX06N3PNEFA(S)	WX06N3PNEFA(S)	
	WX06N3PNEDOA(S)	WX06N3PNEDOA(S)	
	WX06N3PNMDOA(S)	WX06N3PNMDOA(S)	

#Price Changes for ACB with high end release w.r.t MicroPro2 3.1 ACB

Release	Description	MRP (₹)	Ordering Code
MicroPro2 3.1	LSIG	As mentioned above in Reference	A
MicroPro2 4.1	LSING, Thermal Memory, Last Fault Trip History & current display	Add 6595	B
MicroPro2 7.1	LSING, Earth Leakage Protection, Trip History, Over & under voltage/ Frequency, voltage imbalance, current imbalance, Reverse power, Phase Sequence, Leakage Alarm, Current imbalance Protection, Fault Indication, current, voltage and power display with maximeter feature with inbuilt communication	Add 49465	C
Without Release	For ordering ACB without release (Reduce from MRP of ACB with Micropro2 - 3.1 release)	Reduce 6000	C

- NOTES:**
- 1) While ordering an ACB, the complete catalogue reference by replacing '1' with ACB type: MF-Manual Fixed, EF-Electrical Fixed, MDO-Manual Drawout, EDO-Electrical Drawout
 - 2) In TP ACB, if earth fault facility required. Please add Price of neutral CT to ACB Price as mentioned above.
 - 3) Other options of terminals are available on request.
 - 4) #For ordering replace A with B or C, as per requirement.
 - 5) All configurable products are non stockable.



WiNmaster2/3 Air Circuit Breaker Accessories

Main Accessories (Please specify ACB rating & type while placing order)

1. Under Voltage Trip Device				[HSN Code: 8538]
Sl. No.	Compatible with	Description	Reference	MRP (₹)
1.1	WM2/ WM3	Without Delay Common for 630A-4000A	CS-WM2-AUH-V-ABC-**	9210
1.2	WM2/ WM3	With Delay Common for 630A-4000A	CS-WM2-AUH-D-ABC-**	10070

2. Continuous rated Shunt Trip and Closing Coil				[HSN Code: 8538]
Sl. No.	Compatible with	Description	Reference	MRP (₹)
2.1	WM2/ WM3	Shunt Coil Common for 630A-4000A	CS-WM2-AVH-SC-ABC-**	4600
2.2	WM2/ WM3	Closing Coil Common for 630A-4000A	CS-WM2-AVH-CC-ABC-**	4600

3. Accessories				[HSN Code: 8538]
Sl. No.	Compatible with	Description	Reference	MRP (₹)
3.1	WM2 / WM3	Universal Charging Motor-Common for 630A-2500A (for 220VAC/DC)	CS-WM2-AMH-AV-A-M	40810
3.2	WM2 / WM3	Universal Charging Motor-Common for 630A-2500A (for 415VAC)	CS-WM2-AMH-AU-A1-N	
3.3	WM2 / WM3	Universal Charging Motor-Common for 630A-2500A (for 110VAC/DC)	CS-WM2-AMH-AS-A1-F	
3.4	WM3	Universal Charging Motor for Frame2, Common for 800A-4000A (for 220VAC/DC)	CS-WM3-AMH-AV-A2-M	POR
3.5	WM3	Universal Charging Motor for Frame2, Common for 800A-4000A (for 415VAC)	CS-WM3-AMH-AU-A2-N	
3.6	WM3	Universal Charging Motor for Frame2, Common for 800A-4000A (for 110VAC/DC)	CS-WM3-AMH-AS-A2-F	
3.7	WM2 / WM3	LIFTER	LIFTER (580x600)*	171120
			LIFTER-SPL (690x570)*	188140
3.8	WM2 / WM3	Mismatch Prevention Device	CS-WM2-MIP-AB	1830
3.9	WM2	Panel Door Lock (Drawout)	CS-WM2-PDL-AB	2630
3.10	WM2 / WM3	Mechanical interlock for interlocking 2 ACBs (Drawout)	CS-WM2-MIL-HD	43340
3.11	WM2 / WM3	Mechanical interlock for interlocking 2 ACBs (Fixed)	CS-WM2-MIL-HF	37030
3.12	WM2 / WM3	Key Lock (1 Lock + 1 Key)	CS-WM2-AKI-AB	7400
3.13	WM2 / WM3	Key Lock (3 Lock + 2 Key)	CS-WM2-AKI-1-AB	7740
3.14	WM2 / WM3	Key Lock (2 Lock + 1 Key)	CS-WM2-AKI-2-AB	5910
3.15	WM2 / WM3	Mechanical operation counter	CS-WM2-ASC-ABC	3390
3.16	WM2 / WM3	Ready to close contact	CS-WM2-RTC-ABC	1830
3.17	WM2 / WM3	Phase Barrier - 3 Pole (Drawout)	CS-WM2-PB-3P	POR
3.18	WM2 / WM3	Phase Barrier - 4 Pole (Drawout)	CS-WM2-PB-4P	
3.19	WM2 / WM3	Mechanical Interlock for 1 to 3 ACBs-Drawout (Cable Interlock)	CS-WM2-MIL3-HD	51850
3.20	WM2 / WM3	Mechanical Interlock for 1 to 3 ACBs - Fixed (Cable Interlock)	CS-WM2-MIL3-HF	56120
3.21	WM2 / WM3	Panel Door Lock (Fixed)	CS-WM2-PDLF-AB	POR
3.22	WM2 / WM3	Phase Barrier- 3Pole (Fixed)	CS-WM2-PBF-3P	
3.23	WM2 / WM3	Phase Barrier- 4Pole (Fixed)	CS-WM2-PBF-4P	
3.24	WM2 / WM3	Position Indication Switch	CS-WM2-ALB-AB	
3.25	WM2 / WM3	Auxiliary Switch	CS-WM2-AXH-6A6B	
3.26	WM2 / WM3	IP54 cover for Drawout ACB- Frame-1	CS-WM3-CVRIP54-FR1	
3.27	WM3	IP54 cover for Drawout ACB- Frame-2	CS-WM3-CVRIP54-FR2	
3.28	WM3	Panel Door Lock (Drawout)	CS-WM3-DOOR-INT-DRAB	

* in (mm)

**Options for Coil Voltage							
Description	AC Control Voltage			DC Control Voltage			
	110V	220-250V	380-440V	24V	48V	110V	220V
UVT	FA	MA	NA	-	-	FD	MD

Shunt & Closing Coil	100/130V AC/DC	220-250V AC/DC	380V AC	24V DC	28V DC
	F	M	N	BD	ED

NOTES: All configurable products are non stockable.



Winmaster2 ACB Order Form

Please fill separate sheet for each type of ACB. Tick the box in front of each appropriate item and fill in the blanks.

CUSTOMER NAME		ORDER NO. & DATE		DELIVERY DATE		END USER / PANEL BUILDER NAME & PHONE NO.	
RATING OF ACB REQUIRED	<input type="checkbox"/> 630 A	<input type="checkbox"/> 1000 A	<input type="checkbox"/> 1600 A	<input type="checkbox"/> 2500 A	QTY. (NOS.)	Product Reference	
	<input type="checkbox"/> 800 A	<input type="checkbox"/> 1250 A	<input type="checkbox"/> 2000 A				
NO. OF POLES	<input type="checkbox"/> 3 POLE	<input type="checkbox"/> 3P+N	<input type="checkbox"/> 4 POLE	Breaking capacity			
MOUNTING	<input type="checkbox"/> FIXED <input type="checkbox"/> DRAWOUT <input type="checkbox"/> 60 WAY AUX. ISOLATING CONTACT ASSLY.						
	OPERATION	<input type="checkbox"/> MANUAL <input type="checkbox"/> ELECTRICAL		CLOSING COIL <input type="checkbox"/> 110V AC <input type="checkbox"/> 220~250V AC <input type="checkbox"/> 380~440V AC <input type="checkbox"/> 24V DC <input type="checkbox"/> 48V DC <input type="checkbox"/> 110V DC <input type="checkbox"/> 220V DC			
SHUNT TRIP COIL <input type="checkbox"/> 110V AC <input type="checkbox"/> 220~250V AC <input type="checkbox"/> 380~440V AC <input type="checkbox"/> 24V DC <input type="checkbox"/> 48V DC <input type="checkbox"/> 110V DC <input type="checkbox"/> 220V DC							
MOTOR <input type="checkbox"/> 110V AC <input type="checkbox"/> 220V AC <input type="checkbox"/> 415V AC <input type="checkbox"/> 110V DC <input type="checkbox"/> 220V DC							
RELEASES	MICROPROCESSOR RELEASE <input type="checkbox"/> MicroPro2 3.1 <input type="checkbox"/> MicroPro2 4.1 <input type="checkbox"/> MicroPro2 7.1		MAIN CT RATING _____ A, SETTINGS : OVERLOAD _____ A, SHORT CIRCUIT _____ A, GROUND FAULT _____ A INSTANTANEOUS _____ A, NEUTRAL _____ A,				
	UNLESS & OTHERWISE SPECIFIED, ALL SETTINGS OF RELEASES WOULD BE SET AT MINIMUM VALUES.						
ACCESSORIES	<input type="checkbox"/> AUX. SW 6 NO+6 NC <input type="checkbox"/> AUX. SW 4 NO+4 NC <input type="checkbox"/> DOOR INTERLOCK (AVAILABLE ONLY WITH DRAW OUT TYPE ACB)						
	<input type="checkbox"/> UVT <input type="checkbox"/> 110V AC <input type="checkbox"/> 220~250V AC <input type="checkbox"/> 380~440V AC <input type="checkbox"/> 110V DC <input type="checkbox"/> 220V DC		<input type="checkbox"/> MECHANICAL INTERLOCK <input type="checkbox"/> HORIZONTAL (Cable Type)				
	<input type="checkbox"/> KEY INTERLOCK <input type="checkbox"/> 1 ACB <input type="checkbox"/> 2 ACBs <input type="checkbox"/> 3 ACBs		<input type="checkbox"/> SPRING CHARGE IND. SWITCH (ONLY WITH ELECTRICAL ACB)				
SPECIAL REQUIREMENT/ ACCESSORIES (IF ANY)							
Notes : (1) Please refer catalogue / Price-List, for further details of Micropro Release. (2) Neutral CT is required alongwith Microprocessor Release having Ground -Fault Protection. This has to be mounted on Earth / Neutral Busbar of Panel.							

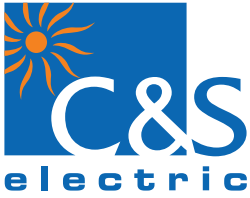

Air Circuit Breaker AH / AHA



The AH/ AHA series circuit breakers are robust circuit breakers complying to IEC 60947-2 & are equipped with unique 'Slow Close Operation of Contacts'.

Equipped with smart features of advance Micropro-V4*

- Power & Current Measurement
- Individual Fault Annunciation
- ZSI
- 100 Event records
- Advance Protection
- SCADA compatibility - RS485 Port
- Data Uploading to PC / Laptop through USB port

Intelligent Protection Releases





Air Circuit Breaker

Air Circuit Breaker AH / AHA

630A-6300A

(I) ACB with Intelligent Release MicroPro 3.1

Features:

- LSIG Protection
- True RMS Sensing
- Fault Indication

(For standard configuration, please refer AH / AHA ACB Order Form)



LT Air Circuit Breaker fitted with Intelligent Release MicroPro 3.1

Fixed 3 Pole			[HSN Code: 8536]	
Rating (Amps)	Breaking Capacity I _{cu} =I _{cs} =I _{cw} (1sec)	Reference	MRP (₹)	
			*MF	*EF
630	50kA	AHA06N3P*MP3.1(S)	142850	195620
800	50kA	AHA08N3P*MP3.1(S)	142850	195620
1000	50kA	AHA10N3P*MP3.1(S)	147790	202520
1250	50kA	AHA12N3P*MP3.1(S)	177160	238750
1600	50kA	AHA16N3P*MP3.1(S)	187340	240730
2000	50kA	AHA20N3P*MP3.1(S)	230690	313380
2500	50kA	AHA25N3P*MP3.1(S)	277870	337710
3200	65kA	AH30DCSMP3.1*(S)	415990	488030
4000	85kA	AH40DCSMP3.1*(S)	670200	730020

Fixed 4 Pole			[HSN Code: 8536]	
Rating (Amps)	Breaking Capacity I _{cu} =I _{cs} =I _{cw} (1sec)	Reference	MRP (₹)	
			*MF	*EF
630	50kA	AHA06N4P*MP3.1(S)	178230	229890
800	50kA	AHA08N4P*MP3.1(S)	178230	229890
1000	50kA	AHA10N4P*MP3.1(S)	182580	236950
1250	50kA	AHA12N4P*MP3.1(S)	222540	280060
1600	50kA	AHA16N4P*MP3.1(S)	254500	304030
2000	50kA	AHA20N4P*MP3.1(S)	304930	385040
2500	50kA	AHA25N4P*MP3.1(S)	347160	418360
3200	65kA	AH30D4CSMP3.1*(S)	551930	617190
4000	85kA	AH40D4CSMP3.1*(S)	799350	913530

Drawout 3 Pole			[HSN Code: 8536]	
Rating (Amps)	Breaking Capacity I _{cu} =I _{cs} =I _{cw} (1sec)	Reference	MRP (₹)	
			*MD	*ED
630	50kA	AHA06N3P*MP3.1(S)	216430	265690
800	50kA	AHA08N3P*MP3.1(S)	216430	265690
1000	50kA	AHA10N3P*MP3.1(S)	226610	275870
1250	50kA	AHA12N3P*MP3.1(S)	261830	304010
1600	50kA	AHA16N3P*MP3.1(S)	278250	342100
2000	50kA	AHA20N3P*MP3.1(S)	353480	406250
2500	50kA	AHA25N3P*MP3.1(S)	427000	479890
3200	65kA	AHA30S3P*MP3.1(S)	545930	599110
4000	65kA	AHA40S3P*MP3.1(S)	680470	717930
4000	85kA	AH40DCSMP3.1*(S)	708270	740900
5000	85kA	AH50CCSMP3.1*(S)	POR	POR
6300	100kA	AH60CCSMP3.1*(S)		

Drawout 4 Pole			[HSN Code: 8536]	
Rating (Amps)	Breaking Capacity I _{cu} =I _{cs} =I _{cw} (1sec)	Reference	MRP (₹)	
			*MD	*ED
630	50kA	AHA06N4P*MP3.1(S)	279970	334590
800	50kA	AHA08N4P*MP3.1(S)	279970	334590
1000	50kA	AHA10N4P*MP3.1(S)	286220	346440
1250	50kA	AHA12N4P*MP3.1(S)	337660	369890
1600	50kA	AHA16N4P*MP3.1(S)	361400	409710
2000	50kA	AHA20N4P*MP3.1(S)	459170	498840
2500	50kA	AHA25N4P*MP3.1(S)	539610	583010
3200	65kA	AHA30S4P*MP3.1(S)	635850	714110
4000	65kA	AHA40S4P*MP3.1(S)	906960	917810
4000	85kA	AH40D4CSMP3.1*(S)	919440	931440
5000	85kA	AH50C4CSMP3.1*(S)	POR	POR
6300	100kA	AH60C4CSMP3.1*(S)		

NOTES: All configurable products are non stockable.



Air Circuit Breaker

Air Circuit Breaker AH / AHA

630A-6300A

(III) ACB with Thermal Magnetic Release

(For standard configuration, please refer AH / AHA ACB Order Form)

LT Air Circuit Breaker fitted with Thermal Magnetic Release and Standard Accessories, as applicable.

Fixed 3 Pole			[HSN Code: 8536]	
Rating (Amps)	Breaking Capacity Icu=Ics=Icw (1sec)	Reference	MRP (₹)	
			*MF	*EF
630	50kA	AHA06N3P*TM(S)	114840	160000
800	50kA	AHA08N3P*TM(S)	123050	177640
1000	50kA	AHA10N3P*TM(S)	125550	178690
1250	50kA	AHA12N3P*TM(S)	167200	217490
1600	50kA	AHA16N3P*TM(S)	173430	233440
2000	50kA	AHA20N3P*TM(S)	199200	277680
2500	50kA	AHA25N3P*TM(S)	223300	321130
3200	65kA	AH30DCSTM*(S)	373560	448930
4000	85kA	AH40DCSTM*(S)	578510	652900

Fixed 4 Pole			[HSN Code: 8536]	
Rating (Amps)	Breaking Capacity Icu=Ics=Icw (1sec)	Reference	MRP (₹)	
			*MF	*EF
630	50kA	AHA06N4P*TM(S)	153750	198000
800	50kA	AHA08N4P*TM(S)	163150	207680
1000	50kA	AHA10N4P*TM(S)	166010	216740
1250	50kA	AHA12N4P*TM(S)	207540	261850
1600	50kA	AHA16N4P*TM(S)	224770	286550
2000	50kA	AHA20N4P*TM(S)	272420	332340
2500	50kA	AHA25N4P*TM(S)	321910	381160
3200	65kA	AH30D4CSTM*(S)	467190	535790
4000	85kA	AH40D4CSTM*(S)	685210	794640

Drawout 3 Pole			[HSN Code: 8536]	
Rating (Amps)	Breaking Capacity Icu=Ics=Icw (1sec)	Reference	MRP (₹)	
			*MD	*ED
630	50kA	AHA06N3P*TM(S)	183330	236750
800	50kA	AHA08N3P*TM(S)	185330	243880
1000	50kA	AHA10N3P*TM(S)	190390	246960
1250	50kA	AHA12N3P*TM(S)	229660	278720
1600	50kA	AHA16N3P*TM(S)	265280	312710
2000	50kA	AHA20N3P*TM(S)	313900	360380
2500	50kA	AHA25N3P*TM(S)	378700	428250
3200	65kA	AHA30S3P*TM(S)	477150	527330
4000	65kA	AHA40S3P*TM(S)	631970	681200
4000	85kA	AH40DCSTM*(S)	664060	722860
5000	85kA	AH50CCSTM*(S)	POR	POR
6300	100kA	AH60CCSTM*(S)	POR	POR

Drawout 4 Pole			[HSN Code: 8536]	
Rating (Amps)	Breaking Capacity Icu=Ics=Icw (1sec)	Reference	MRP (₹)	
			*MD	*ED
630	50kA	AHA06N4P*TM(S)	230160	292430
800	50kA	AHA08N4P*TM(S)	235180	303580
1000	50kA	AHA10N4P*TM(S)	242920	307350
1250	50kA	AHA12N4P*TM(S)	294630	343170
1600	50kA	AHA16N4P*TM(S)	323670	372910
2000	50kA	AHA20N4P*TM(S)	409260	434260
2500	50kA	AHA25N4P*TM(S)	485560	525060
3200	65kA	AHA30S4P*TM(S)	595390	646560
4000	65kA	AHA40S4P*TM(S)	802920	825360
4000	85kA	AH40D4CSTM*(S)	810230	863260
5000	85kA	AH50C4CSTM*(S)	POR	POR
6300	100kA	AH60C4CSTM*(S)	POR	POR

NOTES: All configurable products are non stockable.



Air Circuit Breaker

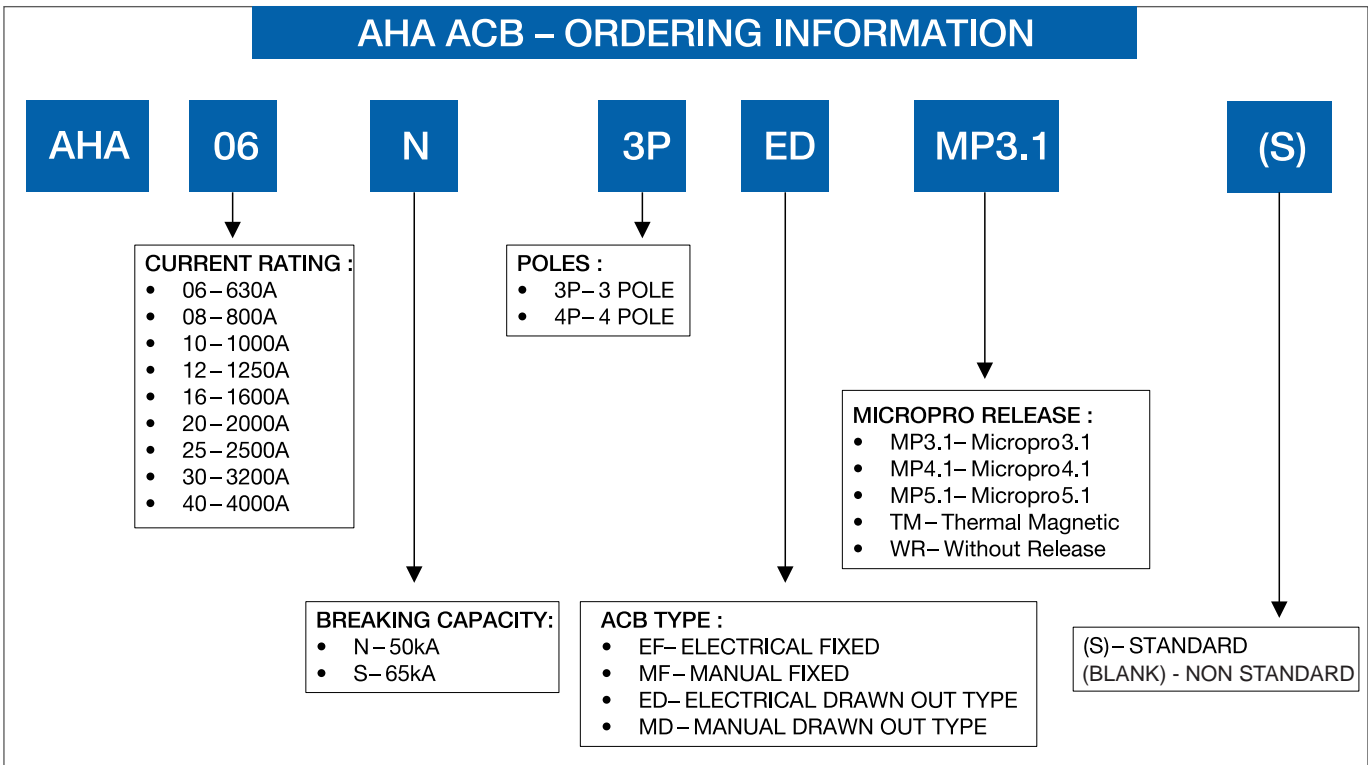

List Price & Reference changes as per the release modification	Ordering Code	MRP (₹)
MicroPro 4.1 (LSING, Display, Current Measurement, Trip History, Communication) add to the price of ACB with MP3.1	ADD	18340
MicroPro5.1 (LSING, Display, Current Measurement, Trip History, ZSI, Communication) add to the price of ACB with MP3.1	ADD	27570

NOTES:

- 1) In TP ACB if Earth Fault facility is required, add price of Neutral CTs from table no. 4.1 on page 19.
- 2) Drawout type ACB with vertical terminal (factory fitted only) is available in ratings 8D~16D/06N-20S (AHA)
- 3) Fixed type ACB with vertical terminal adapter option is available in rating 8D~16D/06N-20S (AHA). For further detail, please refer item No. 32 on page 21.
- 4) All configurable products are non stockable.

For ordering ACB without Release following price needs to be reduced as per the rating from the price of ACB with Thermal Magnetic Release.	Remarks	MRP (₹)
630A-1600A	Reduce	6240
2000A	Reduce	7800
2500A-3200A	Reduce	10100
4000A	Reduce	12140

Notes :

- In TP ACB if Earth Fault facility is required, add prices of Earth Fault Relay from item no. 2 on page 18 & item No. 4.2 on page 19
- Drawout type ACB with vertical terminal (factory fitted only) is available in ratings 6D~16D/08N-20S(AHA)



Air Circuit Breaker

Air Circuit Breaker (B-Type)

630A-2000A

- Auxiliary Switch 1NO*
- Main CTs
- Shunt Trip

*Auxiliary Switch with other combination is also available. See item No. 6.1 & 6.2 only on page 20.



Manual Fixed, 3 Pole with Thermal Magnetic Release			[HSN Code: 8536]
Rating (Amps)	Breaking Capacity Icu=Ics=Icw (1sec)	Reference	MRP (₹) MF
630	50kA	AH06BCSTM*(S)	106940
800	50kA	AH08BCSTM*(S)	107490
1000	50kA	AH10BCSTM*(S)	108450
1250	50kA	AH12BCSTM*(S)	122650
1600	50kA	AH16BCSTM*(S)	147500
2000	50kA	AH20BCSTM*(S)	162260

Manual Fixed, 3 Pole with Intelligent Release MicroPro 3.1			[HSN Code: 8536]
Rating (Amps)	Breaking Capacity Icu=Ics=Icw (1sec)	Reference	MRP (₹) MF
630	50kA	AH06BCSMP3.1*(S)	113570
800	50kA	AH08BCSMP3.1*(S)	118250
1000	50kA	AH10BCSMP3.1*(S)	126110
1250	50kA	AH12BCSMP3.1*(S)	161670
1600	50kA	AH16BCSMP3.1*(S)	184540
2000	50kA	AH20BCSMP3.1*(S)	201220

1. Main Accessories-AH / AHA (Please specify ACB rating & type while placing order)			[HSN Code: 8538]
Sl. No.	Description	Reference	MRP (₹)
1.0	Earth Fault Relay for 6D-60C / 06N-40S	CS-EFR	7820

2. Earth Fault Relay (for ACB with thermal release)					[HSN Code: 8538]
Sl. No.	EFR with NCT and Wiring Bunch for 3P Breaker			EFR with Wiring Bunch for 4P Breaker	
	Description	Reference	MRP (₹)	Reference	MRP (₹)
2.1	06D/06N	CS-EFR-06D3P	10350	CS-EFR-06D4P	7510
2.2	08D/08N	CS-EFR-08D3P		CS-EFR-08D4P	
2.3	10D/10N	CS-EFR-10D3P		CS-EFR-10D4P	
2.4	12D/12N	CS-EFR-12D3P		CS-EFR-12D4P	
2.5	16D/16N	CS-EFR-16D3P		CS-EFR-16D4P	
2.6	20N/20S	CS-EFR-20N3P	12040	CS-EFR-20N4P	7830
2.7	20D	CS-EFR-20D3P		CS-EFR-20D4P	
2.8	25D/25N	CS-EFR-25D3P		CS-EFR-25D4P	
2.9	30S	CS-EFR-30S3P		CS-EFR-30S4P	
2.10	30D	CS-EFR-30D3P		CS-EFR-30D4P	
2.11	40S	CS-EFR-40S3P	16410	CS-EFR-40S4P	9010
2.12	40D	CS-EFR-40D3P		CS-EFR-40D4P	
2.13	50C	CS-EFR-50C3P		CS-EFR-50C4P	
2.14	60C	CS-EFR-60C3P	POR	CS-EFR-60C4P	POR



3. FRP Safety Shutter Assembly			[HSN Code: 8538]
Sl. No.	Description	Reference	MRP (₹)
3.1	For 6D-16D / 06N-16N, 3 Pole	ASH-1	3370
	For 6D-16D / 06N-16N, 4 Pole	ASH-1 (4P)	4350
3.2	For 20N / 20S, 3 Pole	ASH-1-20N/S (3P)	3540
	For 20N / 20S, 4 Pole	ASH-1-20N/S (4P)	4530
3.3	For 20D-25D/30S, 3 Pole	ASH-2	3850
	For 20D-25D/30S, 4 Pole	ASH-2 (4P)	5010
3.4	For 30D/40S, 3 Pole	ASH-3	5240
	For 30D/40S, 4 Pole	ASH-3 (4P)	7490
3.5	For 40D, 3 Pole	ASH-4	6410
	For 40D, 4 Pole	ASH-4 (4P)	8390
3.6	For 50C / 60C, 3 Pole	ASH-5	POR
	For 50C / 60C, 4 Pole	ASH-5 (4P)	POR

NOTES: All configurable products are non stockable.

Main Accessories For "AH/AHA" ACB

(Please specify ACB rating & type while placing orders)

[HSN Code: 8538]

4.1 Single Phase Resin Cast CTs for "AH/AHA" ACB for MicroPro 3.1, 4.1 & 5.1 Release

1CT per pole is required. In TP ACB, one additional CT will be required if, Ground Fault Protection is selected.

Sl. No.	Type	Description	Phase CT	Neutral CT	MRP (₹)
4.1.1	-	100/0.2A	CS-WMCT-014	CS-ATBWM-010	3930
4.1.2	-	200/0.2A	CS-WMCT-02	CS-ATBWM-02	
4.1.3	-	250/0.2A	CS-WMCT-024	CS-ATBWM-024	
4.1.4	-	300/0.2A	CS-WMCT-034	CS-ATBWM-030	
4.1.5	-	400/0.2A	CS-WMCT-044	CS-ATBWM-040	
4.1.6	6D / 06N	630/0.2A	CS-WMCT-064	CS-ATBWM-060	
4.1.7	8D/08N	800/0.2A	CS-WMCT-084	CS-ATBWM-080	4140
4.1.8	10D/10N	1000/0.2A	CS-WMCT-104	CS-ATBWM-110	
4.1.9	12D / 12N	1250/0.2A	CS-WMCT-124	CS-ATBWM-120	
4.1.10	16D / 16N	1600/0.2A	CS-WMCT-164	CS-ATBWM-160	
4.1.11	20N/20S	2000/0.2A	CS-WMCT-220	CS-ATBWM-220	5530
4.1.12	20D	2000/0.2A	CS-ATBWM-220	CS-ATBWM-220	
4.1.13	25D / 25N	2500/0.2A	CS-ATBWM-225	CS-ATBWM-225	6910
4.1.14	30S	3200/0.2A	CS-ATBWM-2532	CS-ATBWM-332	
4.1.15	30D	3200/0.2A	CS-ATBWM-332	CS-ATBWM-332	9880
4.1.16	40S / 40D	4000/0.2A	CS-ATBWM-440	CS-ATBWM-440	
4.1.17	50C	5000/0.2A	CS-ATBWM-550	CS-ATBWM-554	POR
4.1.18	60C	6300/0.2A	CS-ATBWM-660	CS-ATBWM-664	



4.2 Single Phase Resin Cast CTs for "AH/AHA" ACB for Thermal release

1 CT per pole is required. In TP ACB, one additional CT will be required if, Ground Fault Protection is selected.

Sl. No.	Type	Description	Phase CT	Neutral CT	MRP (₹)
4.2.1		100/5A	CS-ATB-014	CS-ATB-010	3650
4.2.2		200/5A	CS-ATB-020	CS-ATB-020N	
4.2.2	-	250/5A	CS-ATB-024	CS-ATB-020	
4.2.4		300/5A	CS-ATB-034	CS-ATB-030	
4.2.5	-	400/5A	CS-ATB-044	CS-ATB-040	
4.2.6	6D / 06N	630/5A	CS-ATB-064	CS-ATB-060	
4.2.7	8D/08N	800/5A	CS-ATB-084	CS-ATB-080	3740
4.2.8	10D/10N	1000/5A	CS-ATB-104	CS-ATB-110	
4.2.9	12D / 12N	1250/5A	CS-ATB-134	CS-ATB-120	
4.2.10	16D / 16N	1600/5A	CS-ATB-164	CS-ATB-160	
4.2.11	20N/20S	2000/5A	CS-ATB-220	CS-ATB-220	4920
4.2.12	20D	2000/5A	CS-ATB-220	CS-ATB-220	
4.2.13	25D / 25N	2500/5A	CS-ATB-225	CS-ATB-225	5530
4.2.14	30S	3200/5A	CS-ATB-2532	CS-ATB-332	
4.2.15	30D	3200/5A	CS-ATB-332	CS-ATB-332	6410
4.2.16	40S / 40D	4000/5A	CS-ATB-440	CS-ATB-440	
4.2.17	50C	5000/5A	CS-ATB-554	CS-ATB-550	9170
4.2.18	60C	5000/5A	CS-ATB-664	CS-ATB-660	



5. Auxiliary Isolating Contact Assembly

Sl. No.	Description	Reference	MRP (₹)	
5.1	24 way 6D-16D/06N-20S, 3P 6D-16D/06N-20S, 4P 20D-25D/25N-30S,3P 20D-25D/25N-30S, 4P 30D-40D/40S, 3P 30D-40D/40S, 4P 50C-60C, 3P 50C-60C, 4P	Set of two contact block on ACB Side & four block on Cradle side	CS-AIH-2-116 CS-AIH-2-116 (4P) CS-AIH-2-220 CS-AIH-2-220 (4P) CS-AIH-2-320 CS-AIH-2-320 (4P) CS-AIH-2-440 CS-AIH-2-440 (4P)	4900
5.2	36 way 6D-16D/06N-20S, 3P 6D-16D/06N-20S, 4P 20D-25D/25N-30S,3P 20D-25D/25N-30S, 4P 30D-40D/40S, 3P 30D-40D/40S, 4P 50C-60C, 3P 50C-60C, 4P	Set of three contact block on ACB Side & six block on Cradle side	CS-AIH-3-116 CS-AIH-3-116 (4P) CS-AIH-3-220 CS-AIH-3-220 (4P) CS-AIH-3-320 CS-AIH-3-320 (4P) CS-AIH-3-440 CS-AIH-3-440 (4P)	15000

NOTES: All configurable products are non stockable.



Main Accessories For "AH/AHA" ACB

(Please specify ACB rating & type while placing orders)



6. Auxiliary Switch				[HSN Code: 8538]
Sl. No.	Description	Reference	MRP (₹)	
6.1	5 way (3NO+2NC)	6D-16D/06N-20S	CS-AXH-3A2B-116	1930
		20D-40D/25N-40S	CS-AXH-3A2B-220	1930
6.2	10 way (5NO+5NC)	6D-16D/08N-20S	CS-AXH-5A5B-116	2910
		20D-40D/25N-40S / 50C-60C	CS-AXH-5A5B-220	2910
6.3	14 way (7NO+7NC)	6D-16D/06N-20S	CS-AXH-7A7B-116	4750
		20D-40D/25N-40S / 50C-60C	CS-AXH-7A7B-220	4750



7. UVT Device				[HSN Code: 8538]
Sl. No.	Description	Reference	MRP (₹)	
7.1	Compact UVT Coil6D-16D/06N-20S	CS-AUH-V-A-**	6660	
7.2	20D-40D/25N-40S / 50C-60C	CS-AUH-V-B-**		



8. Shunt Trip and Closing Coil				[HSN Code: 8538]
Sl. No.	Description	Reference	MRP (₹)	
8.1	Shunt Trip 6D-16D/06N-20S	CS-AVH-S-116-**	3710	
	20D-40D/25N-40S/50C-60C	CS-AVH-S-220-**		
8.2	Closing Coil 6D-16D/06N-20S	CS-AVH-C-116-**	3710	
	20D-40D/25N-40S/ 50C-60C	CS-AVH-C-220-**		

**Please specify voltage while ordering

**Options for Coils Voltage							
Description	AC Control Voltage			DC Control Voltage			
	100~130V	220~250V	380~440V	24V	48V	100~130V	220~250V
UVT	FA	MA	NA	-	-	FD	MD
SHUNT	FA	MA	NA	BD	ED	FD	MD
Closing Coil	FA	MA	NA	BD	ED	FD	MD



[HSN Code: 8538]

Sl. No.	Description	Suitable for ACB frame size /rating			
		6D-16D/06N-20S Reference	MRP (₹)	20D-40D/25S-40S / 50C-60C Reference	MRP (₹)
9	OCR (Fault) Alarm Switch (for fault indication in ACB with MP & TM release)	ALA-1	1120	ALA-2	1120
10	Trip Indication Switch (For both manual and Fault indication in ACB)	CS-TIS-1	1120	CS-TIS-2	
11	Spring Charged Indication Switch	SCIS-M	1470	SCIS-M2	1470
12	Position Indication Switch (Right side)	ALB-4P-1	3660	ALB-IP-2	3660
13	Position Indication Switch (Left side)	ALB-FR-1-L	3660	ALB-FR-2-L	3660
14	Mechanical operation counter	ASC-1	3390	ASC-2	3390
15	Key Lock (One lock + One key)	AKI-116D	2570	AKI-2D	2570
16	Castle Key Lock-3 Pole	CKI-116 (3P)	7880	CKI-220 (3P)	7880
	Castle Key Lock-4 Pole	CKI-116 (4P)	7880	CKI-220 (4P)	7880
17	Key Interlock (Consisting of 3-Key Locks with 2 Keys (same No.) fitted on 3 ACBs)	AKI-1-1	7000	AKI-1-2	7000
18	Key Interlock (Consisting of 2-Key Locks with 1 Key (same No.) fitted on 2 ACBs)	AKI-2-1	5360	AKI-2-2	5360
19	Short Circuit Contact for Shunting Auxiliary Isolating Contacts when ACB withdrawn	SCC	630	SCC	630
20	Rectifier Unit input 240V AC/ output 24V DC, used for Fault LED Retention	CS-ARO-1BMA	3660	CS-ARO-1BMA	3660
21	Mal Insertion Preventor	MIP-NPCIL	POR	MPI-2-NPCL	POR

NOTES: All configurable products are non stockable.

Spares For "AH / AHA" ACB

(Please specify ACB rating & type while placing order for spares)

[HSN Code: 8538]

Sl. No.	Description	Reference	MRP (₹)
22	Power Supply Module	CSPSPM-MICROPRO	14600
22.1	Communication Module for Micropro 4.1 & 5.1 Release	CSPSCM-MICROPRO	27910
23	*Auxiliary Isolating Contact Blocks		
	Description	Reference	MRP (₹)
	Breaker & Cradle Side 12 Way	AIH-BC	8190

NOTES: *Auxiliary Isolating Contact Blocks has to be order together for Cradle & Breaker side.

Sl. No.	Description	Suitable for ACB frame size / rating					
		6D-16D/ 08N-20S (AHA) Reference		MRP (₹)	20D-25D / 25N-30S Reference		MRP (₹)
		3 Pole	4 Pole				
24	Mechanical Interlock (Fixed Vertical)	MIL-16D3P-VF	MIL-16D4P-VF	12900	MIL-20D3P-VF/4P	MIL-20D4P-VF	13430
25	Mechanical Interlock (Fixed Horizontal)	MIL-16D3P-HF	MIL-16D4P-HF		MIL-20D3P-HF/4P	MIL-20D4P-HF	
26	Mechanical Interlock (D/o Vertical)	MIL-16D3P-VDO	MIL-16D4P-VDO	POR	MIL-20D3P-VDO/4P	MIL-20D4P-VDO	POR
27	Mechanical Interlock (D/o Horizontal)	MIL-16D3P-HDO	MIL-16D4P-HDO	POR	MIL-20D3P-HDO/4P	MIL-20D4P-HDO	POR

Sl. No.	For Air Circuit Breaker	Reference	MRP (₹)
28	Lifter (for all sizes of ACBs)	LIFTER (580x600)*	171120
		LIFTER-SPL (690x570)*	188140
29	Door Interlock		
30	Door Interlock 6D-16D / 06N-20S (Right side)	DOOR-INT-116	3780
31	Door Interlock		
31.1	Door Interlock (20D-40D) / 25N-40S (Right side)	DOOR-INT-220	3780

Sl. No. 25, 26, 30 & 31 should be ordered with ACB & will come at factory fitted.

32. Vertical Terminal Adapter for AH/AHA Fixed type ACB				[HSN Code: 8538]
Sl. No.	Description	Reference	Qty. Required Per Pole*	MRP (₹)
32.1	06N-10N	CUADPTR-VC(6D~8D)	1	6940
32.2	10D-12D & 12N	CUADPTR-VC(10D~12D)	1	8560
32.3	16D & 16N-20S	CUADPTR-VC(16D)	1	10250
32.4	20D-25D & 25N	CUADPTR-VC(20D~25D)	1	22600

33. Drawout Mould Base (Cradle Side)				[HSN Code: 8538]
For ACB Rating	Reference	Qty. Required Per Pole*	MRP (₹)	
6D-16D/08N-20S (AHA)	DRMOULD-20S	2	2230	
20D	DRMOULD-20D	2	2660	
25D/30S (AHA)	DRMOULD-25D	2	3130	
30D/40S (AHA)	DRMOULD-30D	1	6290	
40D	DRMOULD-40D	1	6510	
50C-60C	DRMOULD-60C	1	POR	

34. Arcing Contacts (Set of 1 No. Fixed 1 No. Moving)				[HSN Code: 8538]
For ACB Rating	Reference	Qty. Required Per Pole*	MRP (₹)	
6D-8D / 06N-10N	CS-ARCCONT-08D	1	7040	
10D-12D / 12N	CS-ARCCONT-12D	1	7150	
16D / 16N	CS-ARCCONT-16D	1	7670	
20N (Fixed ACB)	CS-ARCCONT-20N	1	7860	
20N / 20S (Drawout ACB)	CS-ARCCONT-20S	1	8220	
20D	CS-ARCCONT-20D	1	16330	
25D / 25N-30S	CS-ARCCONT-25D	1	16520	
30D/40S	CS-ARCCONT-30D	1	16850	
40D	CS-ARCCONT-40D	1	19590	
50C	CS-ARCCONT-50C	1	POR	
60C	CS-ARCCONT-60C	1		

NOTES: 1. All configurable products are non stockable.
2. *M - Moving, F - Fixed



Spares For "AH/AHA" ACB

(Please specify ACB rating & type while placing order for spares)

35. Main Isolating Contacts (Jaw Contacts)			[HSN Code: 8538]
For ACB Rating	Reference	Qty. Required Per Pole	MRP (₹)*
06N-08N / 10N	CS-MIC-08D(50k)	2	13870
10D-12D / 12N	CS-MIC-12D	2	13870
16D / 16N	CS-MIC-16D	2	14490
20N / 20S	CS-MIC-20S	2	18320
20D	CS-MIC-20D	2	33170
25D / 25N-30S	CS-MIC-25D	2	35330
30D / 40S	CS-MIC-30D	2	57110
40D	CS-MIC-40D	2	68510
50C	CS-MIC-50C	2	POR
60C	CS-MIC-60C	2	POR

*Prices for 2 Nos.

36. Main Fixed Contacts (Upper Terminals)			[HSN Code: 8538]
For ACB Rating	Reference	Qty. Required Per Pole*	MRP (₹)
06N-10N	FIXCONT-08N	1	12960
10D-12D / 12N	FIXCONT-10D-12D	1	13400
16D / 16N	FIXCONT-16D	1	18630
20N(AHA)-Fixed type ACB	FIXCONT-20N	1	19050
20N(AHA)-/20S Drawout ACB	FIXCONT-20S	1	19410
20D	FIXCONT-20D	1	20170
25D / 25N-30S	FIXCONT-25D	1	33410
30D/40S	FIXCONT-30D	1	79010
40D	FIXCONT-40D	1	80540
50C	FIXCONT-50C	1	POR
60C	FIXCONT-60C	1	POR

37. Lower Terminals with fitting plates			[HSN Code: 8538]
For ACB Rating	Reference	Qty. Required Per Pole*	MRP (₹)
6D-8D / 06N-10N (AHA)	LWR-TRNL-8D	1	9140
10D-12D / 12N (AHA)	LWR-TRNL-12D	1	10280
16D / 16N (AHA)	LWR-TRNL-16D	1	14250
20N (AHA) (Fixed ACB)	LWR-TRNL-20N	1	16560
20N(AHA) / 20S(AHA) (Drawout ACB)	LWR-TRNL-20S	1	16780
20D	LWR-TRNL-20C-20D	1	26450
25D / 25N-30S (AHA)	LWR-TRNL-25C-25D	1	32210
30D/40S (AHA)	LWR-TRNL-30C-30D	1	48210
40D	LWR-TRNL-40C-40D	1	84880
50C	LWR-TRNL-50C	1	POR
60C	LWR-TRNL-60C	1	POR

38. Cradle Terminal for Drawout AH/AHA ACB			[HSN Code: 8538]	
For ACB Rating	Reference	Terminal Configuration	Qty. Required Per Pole*	MRP (₹)
6D-8D / 06N-10N	CS-CKTTML-08N	Horizontal	1	8420
	CS-CKTTML-08N(V)	Vertical	1	12780
10D-12D / 12N	CS-CKTTML-12D	Horizontal	1	12500
	CS-CKTTML-12D(V)	Vertical	1	18710
16D / 16N	CS-CKTTML-16D	Horizontal	1	20010
	CS-CKTTML-16D(V)	Vertical	1	26520
20N/20S	CS-CKTTML-20S	Horizontal	1	20010
	CS-CKTTML-20S(V)	Vertical	1	26520
20D	CS-CKTTML-20D	Horizontal	1	20010
	CS-CKTTML-20D(V)	Vertical	1	26520
25D / 25N, 25D / 25N-30S	CS-CKTTML-25D	Horizontal	1	29410
	CS-CKTTML-25D(V)	Vertical	1	58130
30D / 40S	CS-CKTTML-30D	Vertical	1	58230
40D	CS-CKTTML-40D	Vertical	1	73680
50C	CS-CKTTML-50C	Vertical	1	POR
60C	CS-CKTTML-60C	Vertical	1	POR

NOTES: All configurable products are non stockable.

Spares For "AH/AHA" ACB

(Please specify ACB rating & type while placing order for spares)

39. Main Moving Contacts Assembly			[HSN Code: 8538]
For ACB Rating	Reference	Qty. Required Per Pole*	MRP (₹)
6D-8D	MOVMAIN-06D-08D	1	POR
06N-10N	MOVMAIN-08N	1	9840
10D-20D / 12N	MOVMAIN-10D-12D	1	10040
16D / 16N	MOVMAIN-16D	1	14580
20N (AHA)-(Fixed Type ACB)	MOVMAIN-20N	1	16210
20N (AHA)-20S (Drawout Type ACB)	MOVMAIN-20S	1	17980
20D	MOVMAIN-20D	1	19380
25D / 25N-30S	MOVMAIN-25D	1	25440
30D / 40S	MOVMAIN-30D	1	58430
40D	MOVMAIN-40D	1	78000
50C	MOVMAIN-50C	1	POR
60C	MOVMAIN-60C	1	POR

*** To arrive at total quantity per ACB, multiply by 3 or 4 depending upon number of poles in the ACB.



40. Complete Pole Unit (Common for 3 & 4 Pole ACBs)			[HSN Code: 8538]
Sl. No.	For Air Circuit Breaker	Reference	MRP (₹)
40.1	Single Pole unit for 08N-10N	CS-CONDUNIT-8N	29190
40.2	Single Pole unit for 10D / 12D & 12N	CS-CONDUNIT-12D	30460
40.3	Single Pole unit for 16D / 16N	CS-CONDUNIT-16D	36890
40.4	Single Pole unit for 20N (AHA)-F■	CS-CONDUNIT-20N	41410
40.5	Single Pole unit for 20N (AHA)-DO■/20S	CS-CONDUNIT-20S	45760
40.6	Single Pole Unit for 20D	CS-CONDUNIT-20D	55910
40.7	Single Pole Unit for 25D / 25N-30S	CS-CONDUNIT-25D	60630
40.8	Single Pole Unit for 30D/40S	CS-CONDUNIT-30D	121450
40.9	Single Pole Unit for 40D	CS-CONDUNIT-40D	144680
40.10	Single Pole Unit for 50C	CS-CONDUNIT-50C	POR
40.11	Single Pole Unit for 60C	CS-CONDUNIT-60C	POR



41. Arc Chutes			[HSN Code: 8538]
For ACB Rating	Reference	Qty. Required Per Pole*	MRP (₹)
6D-16D/06N-20N	CS-ARCCHT-06D-16D	1	5570
20S	CS-ARCCHT-20S	1	7180
20D	CS-ARCCHT-20D	1	7300
25D/30S	CS-ARCCHT-25D	1	8400
30D/40S	CS-ARCCHT-30D	1	18220
40D	CS-ARCCHT-40D	1	19520
50C	CS-ARCCHT-50C	1	POR
60C	CS-ARCCHT-60C	1	POR

*** To arrive at total quantity per ACB, multiply by 3 or 4 depending upon number of poles in the ACB.



42. Charging Motors (110V AC/DC, 220V AC/DC, 250V AC/DC)			[HSN Code: 8538]
For ACB Rating	Reference	MRP (₹)	
6D-16D / 06N-20S (AHA)	CS-AMH-1	32770	
20D-40D/30S-40S(AHA)	CS-AMH-2	42710	

43. Control Relay for Charging Motor (110V AC/DC, 220V AC/DC)			[HSN Code: 8538]
For ACB Rating	Reference	MRP (₹)	
6D-16D / 06N-20S (AHA)	CS-AMH-1-AS	4550	
20D-40D / 30S-40S (AHA)	CS-AMH-2-AS	5340	

NOTES: All configurable products are non stockable.



Spares For "AH/AHA" ACB

(Please specify ACB rating & type while placing order for spares)

43. Other Spares			[HSN Code: 8538]
Sl. No.	Description	Reference	MRP (₹)
43.1	Micro Switch for Motor cut off 6D-40D/06N-40S /50C-60C	MICROSW *	1660
43.2	Anti-Pumping Relay■ 6D-16D/06N-20S, 3P	CS-ANTPUMPRLY-116	6770
	20D-25D/30S, 3P	CS-ANTPUMPRLY-220	7930
	30D-40D/40S / 50C-60C, 3P	CS-ANTPUMPRLY-320	9100
43.3	Manual Charging Handle 6D-16D/06N-20S	MCLHND-6D-16D	5380
43.4	Manual Charging Handle 20D-40D/25N-40S	MCLHND-20D-40D	5840
43.5	Drawout Handle 6D-16D/06N-20S	DRHND-6D-16D	4440
43.6	Drawout Handle 20D-40D/25N-40S	DRHND-20D-40D	5380
43.7	Magnet Hold Trigger 6D-16D/06N-20S, 3P 6D-16D/06N-20S, 4P	CS-MHT-16D	5840
		CS-MHT-16D-4P	6880
43.8	Magnet Hold Trigger 20D-25D / 25N-30S, 3P 20D-25D / 25N-30S, 4P	CS-MHT-20D-25D3P	7580
		CS-MHT-20D-25D4P	8630
43.9	Magnet Hold Trigger 30D-40D/40S (AHA), 3P 50C-60C 3P	CS-MHT-30D-3P	7820
		CS-MHT-40D-60C3P	
43.10	D/O Telescopic Rail (Left) 6D-16D / 06N-20S 20D-25D / 25N-30S 30D-40D /40S	CS-MHT-30D-60C4P	8870
		DRTRLRAIL (L)-1 DRTRLRAIL (L)-2 DRTRLRAIL (L)-3	2110
43.11	D/O Telescopic Rail (Right) 6D-16D / 06N-20S 20D-25D / 25N-30S 30D-40D / 40S	DRTRLRAIL (R)-1 DRTRLRAIL (R)-2 DRTRLRAIL (R)-3	2110

Note: "***" Please specify ACB rating & type while ordering for spares.

**Options for Anti-Pumping Relay					
	24/30V	48V	110V	220V	415V
AC	--	--	FA	MA	NA
DC	BD	ED	FD	MD	-

NOTES:

- 1) All configurable products are non stockable.
- 2) ■Anti-Pumping Relay same code will be applicable for 4P



AH / AHA ACB Order Form

Please fill separate sheet for each type of ACB . Tick the box in front of each appropriate item and fill in the blanks.

AH/AHA ACB ORDER FORM																										
Customer Name			Order No & Date			Delivery Date			End User/Panel Builder Name & Phone no.			Qty. (NOS.)														
PRODUCT REFERENCE		AH <input type="checkbox"/>		AHA <input type="checkbox"/>																						
RATING OF ACB REQUIRED	630A <input type="checkbox"/>		800A <input type="checkbox"/>		1000A <input type="checkbox"/>		1250A <input type="checkbox"/>		1600A <input type="checkbox"/>		2000A <input type="checkbox"/>															
	2500A <input type="checkbox"/>		3200A <input type="checkbox"/>		4000A <input type="checkbox"/>		5000A <input type="checkbox"/>		6300A <input type="checkbox"/>																	
NO. OF POLES	3 POLE <input type="checkbox"/>			4 POLE <input type="checkbox"/>			BREAKING CAPACITY : AH : D		C		(Only for 50C & 60C)															
							AHA : N		S																	
STANDARD CONFIGURATION	MF		EF		MDO		EDO																			
	Release		Release		Release		Release																			
	Power Supply Module (ac/dc)		Power Supply Module (ac/dc)		Power Supply Module (ac/dc)		Power Supply Module (ac/dc)																			
	Aux Switch 4NO + 4NC		Aux Switch 3NO + 4NC		Aux Switch 4NO + 4NC		Aux Switch 4NO + 4NC																			
	Main CTs		Main CTs		Main CTs		Main CT s																			
			Charging Motor		Safety shutter		Charging Motor																			
			Shunt Trip		36 Way Aux Isolating Contacts		Shunt Trip																			
			Closing Coil				Closing Coil																			
			Anti Pumping Relay				Anti Pumping Relay																			
							Safety shutter																			
							36 Way Aux Isolating Contacts																			
	MF		EF		MDO		EDO																			
	Thermal Magnetic Release		Thermal Magnetic Release		Thermal Magnetic Release		Thermal Magnetic Release																			
	Aux Switch 4NO + 4NC		Aux Switch 3NO + 4NC		Aux Switch 3NO + 3NC		Aux Switch 5NO + 6NC																			
	Main CTs		Charging Motor		Main CTs		Main CT s																			
Shunt Trip		Main CTs		Shunt Trip		Safety shutter																				
		Shunt Trip		Safety shutter		Charging Motor																				
		Closing Coil		24 Way Aux Isolating Contacts		Closing Coil																				
		Anti Pumping Relay				Shunt Trip																				
						Anti Pumping Relay																				
						36 Way Aux Isolating Contacts																				
VOLTAGE RATING	Motor --->		<table border="1" style="display: inline-table; border-collapse: collapse;"> <tr> <td>110V</td> <td>AC</td> <td>DC</td> <td></td> </tr> <tr> <td>220V</td> <td>AC</td> <td>DC</td> <td></td> </tr> </table>		110V	AC	DC		220V	AC	DC		Closing Coil -->		<table border="1" style="display: inline-table; border-collapse: collapse;"> <tr> <td>100~130V AC</td> <td>220~250V AC</td> <td>380~440V AC</td> </tr> <tr> <td>24V DC</td> <td>48V DC</td> <td>110V DC</td> <td>220V DC</td> </tr> </table>		100~130V AC	220~250V AC	380~440V AC	24V DC	48V DC	110V DC	220V DC			
	110V	AC	DC																							
220V	AC	DC																								
100~130V AC	220~250V AC	380~440V AC																								
24V DC	48V DC	110V DC	220V DC																							
	UVT ---->		<table border="1" style="display: inline-table; border-collapse: collapse;"> <tr> <td>100~130V AC</td> <td>220~250V AC</td> <td>380~440V AC</td> </tr> <tr> <td>110V DC</td> <td>220V DC</td> <td></td> </tr> </table>		100~130V AC	220~250V AC	380~440V AC	110V DC	220V DC		Shunt trip coil -->		<table border="1" style="display: inline-table; border-collapse: collapse;"> <tr> <td>100~130V AC</td> <td>220~250V AC</td> <td>380~440V AC</td> </tr> <tr> <td>24V DC</td> <td>48V DC</td> <td>110V DC</td> <td>220V DC</td> </tr> </table>		100~130V AC	220~250V AC	380~440V AC	24V DC	48V DC	110V DC	220V DC					
100~130V AC	220~250V AC	380~440V AC																								
110V DC	220V DC																									
100~130V AC	220~250V AC	380~440V AC																								
24V DC	48V DC	110V DC	220V DC																							
ACCESSORIES	Without Release <input type="checkbox"/>		CT Rating _____ A		Thermal Magnetic : Earth Fault : Req'd. <input type="checkbox"/> Not Req'd. <input type="checkbox"/> CT Rating <input type="checkbox"/> NCT Rating <input type="checkbox"/> Setting of non-adj. Mag. Inst. Trip _____																					
	Thermal Magnetic Release <input type="checkbox"/>		Overload _____ A																							
	MicroPro 3.1 <input type="checkbox"/>		Ground Fault _____ A																							
	MicroPro 4.1 <input type="checkbox"/>		Short Circuit _____ A																							
	MicroPro 5.1 <input type="checkbox"/>		Instantaneous _____ A																							
	Communication Module* (Modbus Protocol) <input type="checkbox"/>		Neutral _____ A																							
ACCESSORIES	Trip Ind. Switch <input type="checkbox"/>		Spring charge Ind. Switch <input type="checkbox"/>		Castle Key Interlock** <input type="checkbox"/>																					
	Position Ind. Switch <input type="checkbox"/>		Mech. Operation Counter <input type="checkbox"/>		Key Interlock : 2 ACB <input type="checkbox"/> 3 ACB <input type="checkbox"/>																					
	Key Lock** <input type="checkbox"/>		Door Interlock <input type="checkbox"/>																							
	OCR Alaram Switch <input type="checkbox"/>		Mechanical Interlock : Hor. <input type="checkbox"/> Ver. <input type="checkbox"/>																							
Special Requirements, If any																										
NOTES:	(1) Neutral CT is required alongwith MicroPro Release having Ground-Fault Protection for 3P ACB, used for 3 phase 3 wire system. This has to be mounted on Earth / NeutralBusbar of Panel.																									
	(2) 220V AC Shunt/Closing.Coil/Motor is provided as standard.																									
	(3) Castle lock is not available for C-type Breaker.																									
(4) For WR ACB, Aux contact shall be 4NO+4NC for MF and 3NO+4NC for EF &3NO + 3 NC for MDO and 5NO+6NC for EDO.																										
** (Breaker will be fitted either with Key lock or with Castle key interlock)																										
* (220V AC input is required)																										

NOTE: For thermal magnetic EDO ACB with EFR, Aux Contact shall be 4NO+6NC



B-Type ACB Order Form

Please fill separate sheet for each type of ACB . Tick the box in front of each appropriate item and fill in the blanks.

B TYPE ORDER FORM					
Customer Name	Order No & Date	Delivery Date	End User/Panel Builder Name & Phone	Qty. (NOS.)	
PRODUCT REFERENCE					
RATING OF ACB REQUIRED	630A <input type="checkbox"/> 800A <input type="checkbox"/> 1000A <input type="checkbox"/> 1250A <input type="checkbox"/> 1600A <input type="checkbox"/> 2000A <input type="checkbox"/>				
	NO. OF POLES	3 POLE <input type="checkbox"/>		BREAKING CAPACITY :	
STANDARD CONFIGURATION	With Microprocessor Release	MF			
		Release			
		Power Supply Module (ac/dc)			
		Aux Switch 1NO			
		Main CTs			
	With Thermal Magnetic Release	MF			
		Thermal Magnetic Release			
		Aux Switch 1NO			
		Main CTs			
		Shunt Trip			
UVT ----> 100~130V AC 220~250V AC 380~440V AC Shunt trip coil ----> 100~130V AC 220~250V AC 380~440V AC (W/O time delay) 110V DC 220V DC 24V DC 48V DC 110V DC 220V DC					
RELEASE	Without Release <input type="checkbox"/>	CT Rating _____ A	Thermal Magnetic : Earth Fault : Reqd. <input type="checkbox"/> Not Reqd. <input type="checkbox"/> CT Rating <input type="checkbox"/> NCT Rating <input type="checkbox"/> Setting of non-adj. Mag. Inst. Trip _____		
	Thermal Magnetic Release <input type="checkbox"/>	Overload _____ A			
	MicroPro 3.1 <input type="checkbox"/>	Ground Fault _____ A			
	MicroPro 4.1 <input type="checkbox"/>	Short Circuit _____ A			
	MicroPro 5.1 <input type="checkbox"/>	Instantaneous _____ A			
		Neutral _____ A			
	Trip Ind. Switch <input type="checkbox"/> Mech. Operation Counter <input type="checkbox"/>				
	Key Lock <input type="checkbox"/>				
	OCR Alaram Switch <input type="checkbox"/>				
	Special Requirements, If any				
NOTES	(1) Neutral CT is required alongwith MicroPro Release having Ground-Fault Protection for 3P ACB, used for 3 phase 3 wire system. This has to be mounted on Earth / NeutralBusbar of Panel.				
	(2) 220V AC Shunt is provided as standard.				
	* (220V AC input is required)				



WiNbreak1

Moulded Case Circuit Breaker

- Complying to IEC 60947-2
- Unique 'Reserve Trip Assembly'
- Suitable for voltage up to 690V / Ui 1000 V AC
- Suitable for Motor loads, Capacitor switching
- 100% Ics value ensuring high performance
- Total Selectivity
- Multiple trip units offering variety of choice for the user
- Available with a 'Single Pole' variant MCCB
- Inbuilt Current Measurement & last trip history
- Complete range of accessories
- Communication*

*For communication Module please contact nearest Branch Office.





WiNbreak1 MCCB

- Conforms to IS/IEC 60947-2
- Ics=100% Icu, 75% Icu
- Range: 16A-630A, 3 & 4 Pole
- Breaking capacity: 10kA to 55kA Max.
- Positive Isolation
- Trip free mechanism
- Neutral with 100% rated current
- Bounce free contact structure
- Wide range of Internal & External Accessories
- SS Enclosure available
- Standard packing includes insulating phase barrier and hardware



FMU (Thermal Magnetic) Release ● Adjustable Overload 80-100% ● Fixed short circuit						[HSN Code: 8536]
Size	Rated Current (Amps)	Breaking capacity Icu at 415V AC	3 Pole Reference	MRP (₹)	4 Pole Reference	MRP (₹)
Frame 1	16, 20, 25, 32, 40, 50	25kA	CSE1M125FMU3P-*	7940	CSE1M125FMU4P-*	10210
	16, 20, 25, 32, 40, 50	36kA	CSE1NN125FMU3P-*	10190	CSE1NN125FMU4P-*	12420

ATM (Thermal Magnetic) Release ● Adjustable Overload 80-100% ● Adjustable Short Circuit 5-10 In						[HSN Code: 8536]	
Size	Rated Current (Amps)	Breaking capacity Icu at 415V AC	3 Pole Reference	MRP (₹)	4 Pole Reference	MRP (₹)	
Frame 1	63, 80, 100	25kA	CSE1M125ATM3P-*	8480	CSE1M125ATM4P-*	11200	
	125		CSE1M125ATM3P-*	11620	CSE1M125ATM4P-*	13070	
Frame 2	160		CSE2M250ATM3P-*	15170	CSE2M250ATM4P-*	18180	
	200		CSE2M250ATM3P-*	19150	CSE2M250ATM4P-*	21840	
	250		CSE2M250ATM3P-*	22670	CSE2M250ATM4P-*	25780	
Frame 3	320		CSE3M400ATM3P-*	28900	CSE3M400ATM4P-*	33760	
	350		CSE3M400ATM3P-*	28900	CSE3M400ATM4P-*	33760	
	400		CSE3M400ATM3P-*	29330	CSE3M400ATM4P-*	35640	
Frame 1	63, 80, 100		36kA	CSE1NN125ATM3P-*	10190	CSE1NN125ATM4P-*	12790
	125			CSE1NN125ATM3P-*	11900	CSE1NN125ATM4P-*	13890
Frame 2	160	CSE2NN250ATM3P-*		17560	CSE2NN250ATM4P-*	22320	
	200	CSE2NN250ATM3P-*		21330	CSE2NN250ATM4P-*	24020	
Frame 3	320	CSE3NN400ATM3P-*		29100	CSE3NN400ATM4P-*	34130	
	350	CSE3NN400ATM3P-*		29100	CSE3NN400ATM4P-*	34130	
	400	CSE3NN400ATM3P-*		29480	CSE3NN400ATM4P-*	36030	
Frame 4	500	CSE4NN630ATM3P-500A		33055	CSE4NN630ATM4P-500A	41465	
	630	CSE4NN630ATM3P-630A		33055	CSE4NN630ATM4P-630A	41465	
Frame 1	63, 80, 100	50kA		CSE1S125ATM3P-*	13570	CSE1S125ATM4P-*	16460
	125			CSE1S125ATM3P-*	15900	CSE1S125ATM4P-*	19910
Frame 2	160			CSE2S250ATM3P-*	21020	CSE2S250ATM4P-*	26940
	200			CSE2S250ATM3P-*	23800	CSE2S250ATM4P-*	30110
	250			#CSE2SX250ATM3P-*	24330	#CSE2SX250ATM4P-*	28940
	250			CSE2S250ATM3P-*	25470	CSE2S250ATM4P-*	31620
	320			CSE3S400ATM3P-*	30700	CSE3S400ATM4P-*	35490
Frame 3	350		CSE3S400ATM3P-*	30700	CSE3S400ATM4P-*	35490	
	400		CSE3S400ATM3P-*	31940	CSE3S400ATM4P-*	36610	
	500		CSE4S630ATM3P-500A	41845	CSE4S630ATM4P-500A	51435	
Frame 4	630		CSE4S630ATM3P-630A	41845	CSE4S630ATM4P-630A	51435	

- NOTES :**
1. #Icu 50kA(Ics=75% Icu)
 2. While Ordering, Replace*** by Current Rating, followed by 'A' eg., 350A
 3. For spreader terminals reference code & MRP, please refer page no. 33

WiNbreak1 MCCB

Microprocessor Release 'MicroPro WB'

- Conforms to IS/IEC 60947-2
- Ics=100%Icu
- Range: 40A-400A, 3P & 4P
- Breaking capacity: 36kA & 50kA
- Communication*
- Trip History
- LCD: Indication of measurement and information
- Suitable for isolation
- Adjustable over load from 0.4-1.0In
- Adjustable short circuit from 2-12Ir
- Inbuilt ground fault protection available 20% to 100% of In
- Adjustable neutral overload protection available: 50% to 100% of Ir
- Adjustable current imbalance protection available: (30%-70%) of Ir
- Provision of thermal memory: ON/OFF
- View last trip information



ETM (with in-built Earth fault Protection) ● Adjustable Overload 40 - 100% ● Adjustable shortcircuit 2-12 Ir						[HSN Code: 8536]
Size	Release Range (A)	Breaking Capacity Icu at 415V AC	3 Pole - Reference	MRP (₹)	4 Pole - Reference	MRP (₹)
Frame 1	16-40	36kA	CSE1NN125ETM3P-40A	20690	CSE1NN125ETM4P-40A	24330
	25-63		CSE1NN125ETM3P-63A	20690	CSE1NN125ETM4P-63A	24330
	40-100		CSE1NN125ETM3P-100A	21920	CSE1NN125ETM4P-100A	25540
	50-125		CSE1NN125ETM3P-125A	22640	CSE1NN125ETM4P-125A	27850
Frame 2	63-160		CSE2NN250ETM3P-160A	25990	CSE2NN250ETM4P-160A	30590
	80-200		CSE2NN250ETM3P-200A	30870	CSE2NN250ETM4P-200A	38000
Frame 3	160-400		CSE3NN400ETM3P-400A	45900	CSE3NN400ETM4P-400A	57260
ETM (with in-built Earth fault Protection) ● Adjustable Overload 40-100% ● Adjustable shortcircuit 2-12 Ir ● Ics=100%Icu						[HSN Code: 8536]
Size	Release Range (A)	Breaking Capacity Icu at 415V AC	3 Pole - Reference	MRP (₹)	4 Pole - Reference	MRP (₹)
Frame 1	16-40	50kA	CSE1S125ETM3P-40A	22900	CSE1S125ETM4P-40A	25570
	25-63		CSE1S125ETM3P-63A	22900	CSE1S125ETM4P-63A	25570
	40-100		CSE1S125ETM3P-100A	22900	CSE1S125ETM4P-100A	25570
	50-125		CSE1S125ETM3P-125A	23440	CSE1S125ETM4P-125A	30800
Frame 2	63-160		CSE2S250ETM3P-160A	29180	CSE2S250ETM4P-160A	36540
	80-200		CSE2S250ETM3P-200A	31300	CSE2S250ETM4P-200A	38600
	100-250		CSE2S250ETM3P-250A	31420	CSE2S250ETM4P-250A	46330
	00-250		#CSE2SX250ETM3P-250A	31780	#CSE2SX250ETM4P-250A	40590
Frame 3	160-400	CSE3S400ETM3P-400A	48150	CSE3S400ETM4P-400A	61510	

NOTE: 1. #Icu 50kA(Ics=75% Icu)
 2. While ordering, Replace "*" with Current rating
 3. For spreader terminals reference code & MRP, please refer page no. 33
 4. For 3 Pole ETM (Microprocessor) MCCB one Neutral CT will be required, if ground fault protection is required. For reference & price please refer page 34.
 5. *For Communication Module details please contact nearest Branch Office.



WiNbreak1 MCCB - Frame 'S'

- Conforms to IS/IEC 60947-2
- Ics=100%Icu (for 10kA & 18kA), 75% & 50% for 10kA, 75% for 25kA
- Range: 16A-125A
- Breaking capacity: 10kA, 18kA & 25kA
- Compact Size
- Quick free mechanism
- Precise settings
- Termination possibility for unprepared cables
- Flexibility for installation as Horizontal / Vertical
- Standard packing includes insulating phase barrier and hardware



FMU (Thermal Magnetic) Release ● Adjustable Overload 80-100% ● Fixed short circuit 10In*						[HSN Code: 8536]
Size	Rating Range (A)	Breaking Capacity Icu at 415V AC	3 Pole - Reference	MRP (₹)	4 Pole - Reference	MRP (₹)
Frame 'S'	16, 20, 25, 32, 40, 50,	10kA	CSESK125FMU3P-*A	3360	CSESK125FMU4P-*A	3800
	63, 80, 100A		CSESK125FMU3P-*A	4050	CSESK125FMU4P-*A	5400
	125A		CSESK125FMU3P-*A	4410	CSESK125FMU4P-*A	5630
	16, 20, 25, 32, 40, 50,	18kA	CSESL125FMU3P-*A	5230	CSESL125FMU4P-*A	6840
	63, 80, 100A		CSESL125FMU3P-*A	5370	CSESL125FMU4P-*A	6980
	125A		CSESL125FMU3P-*A	5750	CSESL125FMU4P-*A	7640
	16, 20, 25, 32, 40, 50	25kA*	CSESMX125FMU3P-*A	5670	CSESMX125FMU4P-*A	6970
	63, 80, 100A		CSESMX125FMU3P-*A	5900	CSESMX125FMU4P-*A	7320
	125A		CSESMX125FMU3P-*A	6190	CSESMX125FMU4P-*A	7670

- NOTES :**
1. While Ordering, Replace "*" by Current Rating.
 2. * Ics=75%Icu
 3. For accessories please refer page No. 33
 4. Frame 'S' MCCB with box type terminal is also available on request.
 5. *From 63-125A



Single Pole MCCB

- Conforms to IS/IEC 60947-2
- Ics=100%Icu
- Range: 16A-125A
- Breaking capacity: 10kA
- Standard packing includes Spreader terminals, insulating phase barrier & hardware

FTM (Thermal Magnetic) Release ● Fixed Overload ● Fixed short circuit					[HSN Code: 8536]
Size	Rating (A)	Breaking Capacity Icu at 240V AC	Reference	MRP (₹)	
Frame 1	16, 20, 25, 32, 40	10kA	CSESK125FTM1P-16A	1420	
			CSESK125FTM1P-20A	1420	
			CSESK125FTM1P-25A	1420	
			CSESK125FTM1P-32A	1420	
			CSESK125FTM1P-40A	1420	
			CSESK125FTM1P-50A	1575	
	50, 63, 80, 100, 125		CSESK125FTM1P-63A	1575	
			CSESK125FTM1P-80A	1575	
			CSESK125FTM1P-100A	1575	
			CSESK125FTM1P-125A	1575	

WiNbreak1 MCCB

MCCB for Motor Protection

- Conforms to IS/IEC 60947-2
- Ics=100% Icu
- Range 20A-630A
- Breaking Capacity -50kA
- Upto 50A-Fixed Magnetic setting - Upto 17In
- Adjustable Magnetic setting 6-12In for rating above 50A
- Positive Isolation
- Trip Free mechanism
- Standard packing includes phase barriers and hardware

FMTU (Fixed Magnetic) Release • MTU (Adjustable Magnetic) Release • Adjustable short circuit upto 6-12In				[HSN Code: 8536]
Size	Breaking Capacity Icu at 415V AC	Rating (A)	3 Pole - Reference	MRP (₹)
Frame-1	50kA	20	CSE1S125FMTU3P-20A	9490
		32	CSE1S125FMTU3P-32A	
		50	CSE1S125FMTU3P-50A	
		63	CSE1S125MTU3P-63A	9650
		100	CSE1S125MTU3P-100A	
		125	CSE1S125MTU3P-125A	
Frame-2	50kA	160	CSE2S250MTU3P-160A	16770
		200	CSE2S250MTU3P-200A	21740
		220	CSE2S250MTU3P-220A	27030
		250	CSE2S250MTU3P-250A	
Frame-3	50kA	320	CSE3S400MTU3P-320A	32150
		350	CSE3S400MTU3P-350A	
		400	CSE3S400MTU3P-400A	
Frame-4	50kA	500	CSE4S630MTU3P-500A	32845
		630	CSE4S630MTU3P-630A	

ACCESSORIES											[HSN Code: 8538]
Suitable for use on WB1 MCCBs											
MCCB	Shunt Trip (SHT)	MRP (₹)	Under Voltage Trip (UVT)	MRP (₹)	Auxiliary Switch (AX)	MRP (₹)	Alarm Switch (AL)	MRP (₹)	Combination Switch (AX+AL)	MRP (₹)	
CSES	STW1-S (...V)	1500	-	-	AXWS-L	1140	ALWS-L	1220	XLWS-L	2170	
CSE1	STW1-(...V)	2550	UVTW1-(...V)	4420	AXW1-*	1330	ALW1-*	1330	XLW1-*	3150	
CSE2							ALW1-2*	1330	XLW1-2*	3150	
CSE3 / CSE4	STW1-3(...V)	3780	UVTW1-3(...V)	5160	AXW1-3	1690	ALW1-3*	1690	XLW1-3*	3780	

NOTE:

1. Please replace "*" with L as MCCB Left hand side position & R as MCCB right hand position
2. Maximum Possibilities for Internal Accessories
 - a) 3 Pole, MCCB with Thermal Release, Any two accessories can be fitted at one time
 - b) 4 Pole, MCCB with Thermal Release, Any Three accessories can be fitted at one time
 - c) 3 Pole, MCCB with Microprocessor Release, Right hand seat is not available. Hence, one accessory can be fitted at one time
 - d) 4 Pole, MCCB with Microprocessor Release, Any two accessories can be fitted at one time; Right hand seat is not available
 - e) Alarm & combination switch can be fitted in left hand seat only on CSE3-4P Microprocessor Release MCCB
 - f) UVT can be fitted only in left hand seat
 - g) 3 & 4 Pole, CSES MCCB can have Shunttrip fitment only in Right Side pocket
3. For UVT of CSES Fame, please contact to nearest Branch Office.

Voltage Selection UVT & Shunt			
Size	AC	DC	AC / DC Common
UVT			
CSE1/CSE2	220V, 415V	24V, 48V, 110V, 220V	-
CSE3/CSE4	220V, 415V		220V
Shunt			
CSES	110V, 220V, 415V	110V, 220V	-
CSE1/CSE2	220V, 415V	24V, 48V, 110V, 220V	-
CSE3/CSE4	220V, 415V		24V, 48V, 110V



WiNbreak1 MCCB



Extended Rotary Handle			[HSN Code: 8538]
Suitable for use on WB1 MCCBs	Reference	MRP (₹)	
CSES	EHW1-0T-125	2380	
CSE1	EHW1-125	2650	
CSE2	EHW1-250	3120	
CSE3 / CSE4	EHW1-400-630	3730	

Panel Door Mounted Key Lock for Extended Rotary Handle			[HSN Code: 8538]
Suitable for use on WB1 MCCBs	Reference Code	MRP (₹)	
CSE1	EXTKLWB1-125AF-T1	4320	
CSE2	EXTKLWB1-250AF-T1	4320	
CSE3 / CSE4	EXTKLWB1-400AF-T1	5070	

Mechanical Interlock					[HSN Code: 8538]
Suitable for use on WB1 MCCBs	Applied between two MCCBs				
	Reference 3 Pole	MRP (₹)	Reference 4 Pole	MRP (₹)	
CSE1	MIW1-125-3P	3090	MIW1-125-4P	3820	
CSE2	MIW1-250-3P	3360	MIW1-250-4P	3970	

Note: For CSE3/CSE4 mechanical interlock, please contact with nearest Branch Office.

Locking Devices*					[HSN Code: 8538]
Suitable for use on MCCBs	Key Lock*		Padlocking		
	Reference	MRP (₹)	Reference	MRP (₹)	
CSE1	KLW1-125	1720	PLW1-125	1810	
CSE2	KLW1-250	1870	PLW1-250	2000	
CSE3 / CSE4	-	-	PLW1-400	POR	

* Factory fitted only

Spreader Terminals for WB1 MCCB						[HSN Code: 8538]
Suitable for use on MCCBs		Current Rating (A)	Reference	MRP (₹)	MOQ	
CSES	3 Pole	16 , 20, 25, 32, 40, 50, 63, 80, 90, 100, 125	CSET0033	200	Set of 3	
	4 Pole		CSET0044	300	Set of 4	
CSE1	3 Pole	15, 20, 32, 40, 50, 63	CSET1033	200	Set of 3	
CSE1	3 Pole	80, 100, 125	CSET1033C	290	Set of 3	
CSE1	4 Pole	15, 20, 32, 40, 50, 63	CSET1044	330	Set of 4	
CSE1	4 Pole	80, 100, 125	CSET1044C	400	Set of 4	
CSE2	3 Pole	160, 200	CSET2033	480	Set of 3	
CSE2	3 Pole	250	CSET2503-ST	780	Set of 3	
CSE2	4 Pole	160, 200	CSET2044	720	Set of 4	
CSE2	4 Pole	250	CSET2504-ST	1020	Set of 4	
CSE3	3 Pole	320, 350, 400	CSET3033	1760	Set of 3	
CSE3	4 Pole	320, 350, 400	CSET3044	2430	Set of 4	
CSE3	3 Pole	500, 630	CSET4033-WB1	3900	Set of 3	
CSE4	4 Pole	500, 630	CSET4044-WB1	5300	Set of 4	



SS Enclosure for WB1 MCCB			[HSN Code: 8538]
Size	Suitable for WB1 MCCBs	Reference	MRP (₹)
FrameS	CSES	CSE-ENCL-125S-3P	POR
	CSES	CSE-ENCL-125S-4P	
Frame1	CSE1	CSE-ENCL-125-3P	
	CSE1	CSE-ENCL-125-4P	
Frame2	CSE2	CSE-ENCL-250-3P	
	CSE2	CSE-ENCL-250-4P	

NOTES:

- Reference Code is for Enclosure only (without MCCB)
- For Placing an order for MCCB along with Enclosure, please apply prefix E-before MCCB Reference Code. For Price, please contact nearest Branch Office.

Winbreak1 MCCB



Description	Reference	MRP (₹)
Front Barrier - IP40		
CSES, Front Barrier, 1P (Set of 2)	CSFB1P-S	110
CSES, Front Barrier, 2P,3P (Set of 2)	CSFB3P-S	180
CSES, Front Barrier, 4P (Set of 2)	CSFB4P-S	230
CSE1, Front Barrier, 2P,3P (Set of 2)	CSFB3P-1	190
CSE2, Front Barrier, 2P,3P (Set of 2)	CSFB3P-2	250
CSE3/4, Front Barrier, 3P (Set of 2)	CSFB3P-3	800
CSE1, Front Barrier, 4P (Set of 2)	CSFB4P-1	230
CSE2, Front Barrier, 4P (Set of 2)	CSFB4P-2	300
CSE3/4, Front Barrier, 4P (Set of 2)	CSFB4P-3	1000
Cage Clamp		
Cage Clamps for FRAME-S, WB1 MCCB (Set of 3)	CSCC0033	POR
Cage Clamps for FRAME-S, WB1 MCCB (Set of 4)	CSCC0044	
Cage Clamps for FRAME-1, WB1 MCCB (Set of 3)	CSCC1033	
Cage Clamps for FRAME-1, WB1 MCCB (Set of 4)	CSCC1044	
Cage Clamps for FRAME-2, WB1 MCCB (Set of 3)	CSCC2033	
Cage Clamps for FRAME-2, WB1 MCCB (Set of 4)	CSCC2044	



Earth Fault Relay (Built in CBCT) Suitable for 3 Phase 3 wire distribution network			[HSN Code: 8538]
Rating (Amps)	Earth Fault Relay Setting Range	Reference	MRP (₹)
32A	3.2-32A	EFR-CBCT125-AF-32	7280
40A	4-40A	EFR-CBCT125-AF-40	
63A	6.3-63A	EFR-CBCT125-AF-63	
80A	8-80A	EFR-CBCT125-AF-80	
100A	10-100A	EFR-CBCT125-AF-100	
125A	12.5-125A	EFR-CBCT125-AF-125	7750
200A	20-200A	EFR-CBCT250-AF-200	8660
250A	25-250A	EFR-CBCT250-AF-250	
400A	40-400A	EFR-CBCT400-AF-400	
630A	63-630A	EFR-CBCT630-AF-630	10030
800A	80-800A	EFR-CBCT800-AF-800	
1000A	100-1000A	EFR-CBCT1250-AF-1000	15470
1250A	125-1250A	EFR-CBCT1250-AF-1250	
Earth Fault Relay (with NCT) Suitable for 3 Phase 4 wire distribution network			
40A	4-40A	EFR125-AF-40(N)	6740
100A	10-100A	EFR125-AF-100(N)	
125A	12.5-125A	EFR125-AF-125(N)	
200A	20-200A	EFR250-AF-200	7160
250A	25-250A	EFR250-AF-250	
400A	40-400A	EFR400-AF-400	7990
630A	63-630A	EFR630-AF-630	
800A	80-800A	EFR800-AF-800	9200
1000A	100-1000A	EFR1250-AF-1000	
1250A	125-1250A	EFR1250-AF-1250	15170
NCT Winbreak1 ETM (Microprocessor) 3 Pole MCCB if ground fault facility is required			
40	40/0.1A	ETMNCT40A	2220
63	63/0.1A	ETMNCT63A	
80	80/0.1A	ETMNCT80A	
100	100/0.1A	ETMNCT100A	
125	125/0.1A	ETMNCT125A	
160	160/0.1A	ETMNCT160A	3110
200	200/0.1A	ETMNCT200A	
250	250/0.1A	ETMNCT250A	
400	400/0.1A	ETMNCT400A	



WiNbreak2

An Absolute solution for power distribution

C&S Electric offers innovative, intelligent, integrated and intuitive solution



Conforms to IS/IEC 60947-2

$I_{cs} = 100\% I_{cu}$

$I_{cw} = 25kA$ for 1s

Range : 800A to 1600A, 3P & 4P

Breaking capacity : 50kA, 70kA & 150kA

U_i : 1000V

U_{imp} : 8kV

N Type
(Normal)



A Type
(Ammeter)



P Type
(Power Meter)



S Type
(Supreme Meter)



WiNbreak2 MCCB (1600AF)

Features:

- LSIG Protection
- Thermal Memory
- Current, Voltage, Power, Energy, Frequency measurement
- Trip History
- Digital Display
- Fault recording
- Event Recording
- Communication
- Harmonics
- True RMS Sensing
- ZSI
- IDMTL Setting
- Self Power
- LED for Tripping Information
- RTC Timer
- Pre Trip Alarm

MCCB with Intelligent Release - N Type							[HSN Code: 8536]
Size	Release Range (A)	Breaking Capacity @ 415VAC	3 Pole Reference	MRP (₹)	4 Pole Reference	MRP (₹)	
Frame 5	400-800	50kA	CS1000NNG5800A3P	POR	CS1000NNG5800A4P	POR	
	500-1000		CS1000NNG51000A3P		CS1000NNG51000A4P		
	625-1250		CS1250NNG51250A3P		CS1250NNG51250A4P		
	800-1600		CS1600NNG51600A3P		CS1600NNG51600A4P		
	400-800	70kA	CS1000HNG5800A3P	POR	CS1000HNG5800A4P	POR	
	500-1000		CS1000HNG51000A3P		CS1000HNG51000A4P		
	625-1250		CS1250HNG51250A3P		CS1250HNG51250A4P		
	800-1600		CS1600HNG51600A3P		CS1600HNG51600A4P		

MRP Changes for MCCB with high end release w.r.t "Intelligent release - N Type"		[HSN Code: 8536]
Release		MRP (₹)
Intelligent release - A Type*	ADD	POR
Intelligent release - P Type*	ADD	
Intelligent release - S Type*	ADD	

Note : Standard packing includes insulating phase barriers and Hardwares.

Internal Accessories											[HSN Code: 8538]
WB2 MCCBs	Shunt Trip (SHT)	MRP (₹)	Under Voltage Trip (UVT)	MRP (₹)	Auxiliary Switch (AX)	MRP (₹)	Alarm Switch (AL)	MRP (₹)	Fault Alarm Switch (FAL)*	MRP (₹)	
CS1000-1600	SHT5-T(...V)	POR	UVT5-T(...V)	POR	AX5-T	POR	AL5-T	POR	FAL5-T	POR	

Voltage Selection UVT & Shunt				[HSN Code: 8538]
Size	AC	DC	AC / DC Common	
UVT				
Frame 5	48V, 380-480V	24-30V, 48-60V	100-130V, 200-250V	
Shunt				
Frame 5	48V, 380-480V	24-30V, 48-60V	100-130V, 200-250V	

WB2 MCCBs	Direct Rotary Handle	MRP (₹)	Direct Rotary Handle with Keylock	MRP (₹)	Extended Rotary Handle	MRP (₹)
CS1000-1600	DH5-S	POR	DHK5-S	POR	EH5-S	POR

Mechanical Interlock					[HSN Code: 8538]
WB2 MCCBs	Applied between two MCCBs				
	3 Pole		4 Pole		
	Reference	MRP (₹)	Reference	MRP (₹)	
CS1000-1600	MIT53	POR	MIT54	POR	

Padlocking Device				[HSN Code: 8538]
WB2 MCCBs	Fixed Lock		Removable Lock	
	Reference	MRP (₹)	Reference	MRP (₹)
CS1000-1600	PHL5	POR	PL5	POR

NOTE : Above mentioned products are non stockable.



WiNbreak2 MCCB

- Conforms to IS/IEC 60947-2
- Ics = 100% Icu
- Range: 16A-1600A, 3P & 4P
- Breaking capacity: 50kA, 65kA, 70kA, 85kA & 150kA
- Positive Isolation
- Trip Free Mechanism
- Double contact structure
- Communication compatible
- No Line-load Bias
- Neutral with 100% rated current
- Tripping by pressure
- Current limiting
- Manual, Rotary or Motorized available
- Wide range of internal & external accessories
- Standard packing includes spreaders terminals, insulating phase barriers and hardwares



FMU (Thermal Magnetic) Release ● Adjustable Overload 80-100% ● Fixed short circuit 10 In						[HSN Code: 8536]
Size	Rated Current (Amps)	Breaking capacity Icu at 415V AC	3 Pole Reference	MRP (₹)	4 Pole Reference	MRP (₹)
Frame 1	16, 20, 25, 32, 40, 50, 63	50kA	☒CD100NFMU*3P	15290	☒CD100NFMU*4P	18960
	80, 100		CD100NFMU*3P	15430	CD100NFMU*4P	19130
Frame 3	300, 400	65kA	☒CS400NFMU*3P	50820	CS400NFMU*4P	64870
	500, 630		*CS630NFMU*3P	58060	CS630NFMU*4P	70180
Frame 4	800	65kA	☒CS800NFMU*3P	75000	CS800NFMU*4P	100360

ATU (Thermal Magnetic) Release ● Adjustable Overload 80 - 100% ● Adjustable Short circuit 5 - 10 In						[HSN Code: 8536]
Size	Rated Current (Amps)	Breaking capacity Icu at 415V AC	3 Pole Reference	MRP (₹)	4 Pole Reference	MRP (₹)
Frame 2	125	50kA	CS160NATU*3P	23780	☒CS160NATU*4P	30090
	160		☒CS160NATU*3P	29290	☒CS160NATU*4P	38010
	200		☒CS250NATU*3P	35230	☒CS250NATU*4P	45100
	250		CS250NATU*3P	40460	CS250NATU*4P	54210
Frame 3	300, 400	65kA	*CS400NATU*3P	51910	*CS400NATU*4P	69170
	500, 630		*CS630NATU*3P	61680	*CS630NATU*4P	75310
Frame 4	800	65kA	☒CS800NATU*3P	84150	CS800NATU*4P	104340

ETS (Microprocessor based) Release ● Adjustable Overload 40 - 100% ● Adjustable shortcircuit 1.5 - 10 In						[HSN Code: 8536]
Size	Rated Current (Amps)	Breaking capacity Icu at 415V AC	3 Pole Reference	MRP (₹)	4 Pole Reference	MRP (₹)
Frame 2	40	50kA	CS160NETS*3P	39080	☒CS160NETS*4P	48870
	80, 160		CS160NETS*3P	39620	☒CS160NETS*4P	48880
	250		CS250NETS*3P	48200	☒CS250NETS*4P	61310
Frame 3	400	65kA	CS400NETS*3P	53410	☒CS400NETS*4P	79750
	630		☒CS630NETS*3P	61310	☒CS630NETS*4P	93900
Frame 4	800	65kA	☒CS800NETS*3P	90530	CS800NETS*4P	115510

☒ non stockable items.

ATU - *Rated Current (Amp) 300, 500 for 3 Pole & 4 Pole are non stockable items.

WiNbreak2 MCCB

ETM (Microprocessor Release with in-built Earth fault Protection) ● Adjustable Overload 40 - 100% ● Adjustable shortcircuit 1.5 - 10 In							[HSN Code: 8536]
Size	Rated Current (Amps)	Breaking capacity Icu at 415V AC	3 Pole Reference	MRP (₹)	4 Pole Reference	MRP (₹)	
Frame 3	160	65kA	CS400NETM33160A3PE	88040	CS400NETM33160A4PE	105550	
	250		CS400NETM33250A3PE	88040	CS400NETM33250A4PE	105550	
	400		CS400NETM33400A3PE	88240	CS400NETM33400A4PE	113990	
	630		CS630NETM33630A3PE	106270	CS630NETM33630A4PE	126490	
Frame 4	800	65kA	CS800NETM43800A3PE	148630	CS800NETM43800A4PE	185790	

NOTE :

1. While ordering replace "*" by Current Rating
2. Spreader Terminals are not included MCCBs upto 63A
3. For 3 Pole ETM (Microprocessor) MCCB one Neutral CT will be required, if ground fault protection is required, for reference & MRP Please refer page 39.
4. MCCB with Ammeter, ZSI & communication feature is also available. For reference & MRP contact nearest Branch Office.
5. MCCB for Motor Backup Protection is also available. For prices contact nearest Branch Office.



Accessories											[HSN Code: 8536]
Suitable for use on WB2 MCCBs	Shunt Trip (SHT)	MRP (₹)	Under Voltage Trip (UVT)	MRP (₹)	Auxiliary Switch (AX)	MRP (₹)	Alarm Switch (AL)	MRP (₹)	Fault Alarm Switch (FAL)*	MRP (₹)	
CD100-CS800	ST-T(..V)	4400	UVT-T(..V)	6000	AX-T	1900	AL-T	1900	FAL-T	1900	

NOTE :

1. The above accessories are common for CD100-CS800
2. FAL (Fault Alarm Switch)* It can be applied to only circuit breakers with electronic trip units
3. Maximum Possibilities for Internal Accessories

Voltage Selection UVT & Shunt					
Size	AC	DC	AC / DC Common		
UVT					
Frame 1/2/3/4	380~440V, 440~480V	-	24V, 48V, 110~130V, 200~240VAC / 250VDC		
Shunt					
Frame 1/2/3/4	380~500V	12V	24V, 48V, 110~130V, 200~240VAC / 250VDC		
	Accessory	CD100	CS160/ 250	CS400 / 630	CS800
Left	AX	-	1	3	3
	AL	1	1	-	-
	SHT / UVT	1	1	1	1
Right	AX	2	1	-	-
	AL	-	-	1	2
	FAL	-	1	1	1



Rotary Handle							[HSN Code: 8538]
Suitable for use on WB2 MCCBs	Direct Rotary Handle	MRP (₹)	Direct Rotary Handle with Keylock	MRP (₹)	Extended Rotary Handle	MRP (₹)	
CD100	DH1-S	2370	DHK1-S	6260	EH1-S	3570	
CS160, CS250	DH2-S	2580	DHK2-S	6570	EH2-S	4760	
CS400, CS630	DH3-S	5070	DHK3-S	6890	EH3-S	6660	
CS800	DH4-S	6060	DHK4-S	7180	EH4-S	7850	



Mechanical Interlock (Used to prevent mechanically closing together)					[HSN Code: 8538]
Suitable for use on WB2 MCCBs	3 Pole Reference	MRP (₹)	4 Pole Reference	MRP (₹)	
CD100	MIT13	11300	MIT14	11850	
CS160, CS250	MIT23	13760	MIT24	14240	
CS400, CS630	MIT33	14600	MIT34	14990	
CS800	MIT43	15630	MIT44	15960	

☒ non stockable items.



WiNbreak2 MCCB



Motor Operator - For remote "ON/OFF" operation only		[HSN Code: 8538]	
Suitable for MCCB Type	Control Voltage	Reference	MRP (₹)
CD100	<input checked="" type="checkbox"/> 24V DC	MOP1(..V)	27110
	<input checked="" type="checkbox"/> AC100-240V/DC100-220V		
CS160, CS250	<input checked="" type="checkbox"/> 24V DC	MOP2(..V)	36800
	<input checked="" type="checkbox"/> AC110V/DC110V		
	AC230V/DC220V		
CS400, CS630	<input checked="" type="checkbox"/> 24V DC	MOP3(..V)	56870
	<input checked="" type="checkbox"/> AC110V/DC110V		
	AC230V/DC220V		
CS800	<input checked="" type="checkbox"/> 24V DC	MOP4(..V)	68590
	<input checked="" type="checkbox"/> AC110V/DC110V		
	AC230V/DC220V		

*Replace (....V) by require voltage.



Padlocking Device		[HSN Code: 8538]		
Suitable for use on WB2 MCCBs	Fixed Lock		Removable Lock	
	Reference	MRP (₹)	Reference	MRP (₹)
CD100	<input checked="" type="checkbox"/> PHL 1	1940	<input checked="" type="checkbox"/> PL 1	1110
CS160, CS250	<input checked="" type="checkbox"/> PHL 2	2130	<input checked="" type="checkbox"/> PL 2	1450
CS400, CS630	<input checked="" type="checkbox"/> PHL 3	3430	<input checked="" type="checkbox"/> PL 3	1760
CS800	<input checked="" type="checkbox"/> PHL 4	3470	<input checked="" type="checkbox"/> PL 4	1840

NCT for WiNbreak2 ETM-Microprocessor (3 Pole MCCB if ground fault facility is required)		[HSN Code: 8538]	
Description	Reference	MRP (₹)	
160/0.1A	<input checked="" type="checkbox"/> NCT-WB2-016	7830	
250/0.1A	<input checked="" type="checkbox"/> NCT-WB2-025	8000	
400/0.1A	<input checked="" type="checkbox"/> NCT-WB2-040	8610	
630/0.1A	<input checked="" type="checkbox"/> NCT-WB2-063	9260	
800/0.1A	NCT-WB2-080	9870	

Panel Door Mounted Key Lock for Extended Rotary Handle		[HSN Code: 8538]	
Suitable for WB2 MCCBs	Reference	MRP (₹)	
CD100, CS160, CS250	<input checked="" type="checkbox"/> EXTKLWB2-250AF-T1	3410	

non stockable items.

WiNbreak MCCB - CS Series

- Conforms to IS/IEC 60947-2
- Range: 15A-400A, 2, 3 & 4 Pole
- Breaking capacity: 10kA, 18kA & 25kA
- Positive Isolation
- Trip free mechanism
- SS Enclosure available
- Standard packing includes Spreader terminals, Insulating phase barriers and Hardwares.



FTM (Thermal Magnetic) Release • Fixed Overload • Fixed short circuit								[HSN Code: 8536]
Size	Rated Current (Amps)	Breaking capacity Icu at 415V AC	2 Pole Reference	MRP (₹)	3 Pole Reference	MRP (₹)	4 Pole Reference	MRP (₹)
Frame 1	10, 16, 20, 25, 30, 32, 40, 50, 60, 63□	10kA	☒CS2A2c*	3120	CS2A3c*	3590	CS2A4c*	4930
	75		CS2A2c*	3260	CS2A3c*	3710	☒CS2A4c*	5100
	80		CS2A2c*	3260	☒CS2A3c*	3710	CS2A4c*	5100
	100		CS2A2c*	3260	CS2A3c*	3710	CS2A4c*	5100
	125		-	-	CS2A3c*	5700	CS2A4c*	7550
Frame 2	16, 20, 25, 30, 32, 40, 50, 60, 63	25kA	CS2B2c*	6840	CS2B3c*	7690	CS2B4c*	9360
	75, 80, 100		CS2B2c*	6940	CS2B3c*	7920	CS2B4c*	9570
Frame 3	125, 140, 160#	18kA	-	-	*CS3A3c*	12020	CS3A4c*	15860
	200		CS3A2*	11890	CS3A3c*	13100	CS3A4c*	17130
	250		☒CS3A2*	12960	☒CS3A3c*	14650	CS3A4c*	18240
	125, 140, 160#	25kA	-	-	CS3B3c*	13960	CS3B4c*	18140
	200		☒CS3B2*	15620	CS3B3c*	16140	☒CS3B4c*	20960
	250		CS3B2*	20860	☒CS3B3c*	21920	☒CS3B4c*	27370

NOTES : 1. While ordering replace **# by current rating. 2. #150A & 175A also available on request. 3. □Upto 63A Spreader Terminals are not included.



SS Enclosure for WB MCCB					[HSN Code: 8538]
Size	Suitable for use on MCCBs	Reference* 3 Pole	Reference* 4 Pole	MRP (₹)	
Frame 1	CS2A	☒CS-CNM0100020	☒CS-CNM0100020	3980	
Frame 2	CS2B	CS-CNM0100021	CS-CNM0100021	4010	
Frame 3	CS3A, CS3B	CS-CNM0100021	CS-CNM0100021	4010	

NOTES:

- *Reference code is for Enclosure only (without MCCB)
- For placing an order for MCCB along with Enclosure, please apply Prefix **E-** before MCCB Reference Code. For Price, please contact nearest Branch Office.

Accessories											[HSN Code: 8538]
Suitable for use on MCCBs	Shunt Trip (SHT)	MRP (₹)	Auxiliary Switch (AX)	MRP (₹)	Alarm Switch (AL)	MRP (₹)	Direct Rotary Handle	MRP (₹)	Extended Rotary Handle	MRP (₹)	
CS2A..c	ST-A(..V)	2300	ASW-A(*)	1280	ALSW-A(*)	1280	D-35S	1750	CSE-35S	1620	
CS2B..c	ST-B(..V)	2300	ASW-B(*)	1280	ALSW-B(*)	1280	D-45S	1970	CSE-45S	1620	
CS3A / CS3B..c	ST-C(..V)	2300	ASW-C(*)	1280	ALSW-C(*)	1280	D-55S	2100	CSE-55	1800	

NOTES:

- *Please read R as MCCB left hand side position & T as right hand position.
- For Frame1, Frame 2 & Frame3 shunt trip is available in 12VAC/DC, 24VAC/DC, 48VAC/DC, 110VAC/DC, 220VAC/DC, 415VAC (Replace ST-A(..V) , ST-B(..V) and ST-C(..V) by required voltage)
- For Frame4 shunt trip is available in 24-48VAC/DC, 100-220VDC, 100-240VAC, 380-550VAC/DC (Replace ST-6A (...V) by required voltage)
- Rotary Handle for 2 Pole, Frame1 & Frame2 is not available.
- Maximum possibilities for internal accessories

Frame1, Frame2 & Frame3:

Left hand seat - AX or AL

Right hand seat - AX or AL or SHT

Frame 4:

Left hand seat - 2AX, 2AL and SHT

Right hand seat - 2AX, 2AL and SHT

☒ non stockable items.



WiNbreak MCCB - CSC Series

- Conforms to IS/IEC 60947-2
- Ics=100%Icu
- Range: 15A-1200A, 2, 3 & 4 Pole
- Breaking capacity: 18kA, 26kA, 37kA, 50kA, 65kA & 85kA
- Positive Isolation
- Trip free mechanism
- Wide range of Internal & External Accessories
- SS Enclosure available
- Standard packing includes insulating phase barriers and hardwares



FTM (Thermal Magnetic) Release • Fixed Overload • Fixed short circuit								[HSN Code: 8536]
Size	Rated Current (Amps)	Breaking capacity Icu at 415V AC	2 Pole Reference	MRP (₹)	3 Pole Reference	MRP (₹)	4 Pole Reference	MRP (₹)
Frame 1	15, 20, 30, 40, 50	18kA	CSC1S2*	5490	-	-	-	-
	60, 75, 100		CSC2N2*	5560	-	-	-	
Frame 3	150, 175	26kA	CSC4N2*	13240	-	-	-	-
	200		CSC4N2*	14940	-	-	-	
	250		CSC4N2*	19510	-	-	-	
Frame 2	15, 20, 30, 40, 50, 60	37kA	☒CSC3S2*	7260	-	-	-	-
	75, 100		☒CSC3S2*	7290	-	-	-	
	125		CSC3S2*	7480	-	-	-	
Frame 5	500, 630	-	-	-	CSC6N3*	46390	CSC6N4*	53350
	700, 800		-	-	CSC6N3*	63450	☒CSC6N4*	75770
Frame 4	300◆	65kA	-	-	CSC5H3*	45600	☒CSC5H4*	55630
	350, 400◆		-	-	☒CSC5H3*	47060	☒CSC5H4*	57410
Frame 5	500, 630	-	-	-	☒CSC6S3*	47540	☒CSC6S4*	60680
	700, 800		-	-	CSC6S3*	68750	CSC6S4*	87020
Frame 4	300◆	85kA	-	-	☒CSC5L3*	58400	CSC5L4*	81880
	350, 400◆		-	-	CSC5L3*	59930	☒CSC5L4*	83600
Frame 5	500, 630	-	-	-	CSC6L3*	85720	☒CSC6L4*	107270
	700, 800		-	-	CSC6L3*	146380	CSC6L4*	164660

FTM (Thermal Magnetic) Release • Fixed Overload • Fixed short circuit • Ics=50%Icu								[HSN Code: 8536]
Size	Rated Current (Amps)	Breaking capacity Icu at 415V AC	2 Pole Reference	MRP (₹)	3 Pole Reference	MRP (₹)	4 Pole Reference	MRP (₹)
Frame 6	1000◆	65kA	-	-	CSC7S3*	174100	☒CSC7S4*	217940
	1200◆		-	-	CSC8S3*	185080	CSC8S4*	220770
Frame 6	1000◆	85kA	-	-	CSC7L3*	222460	CSC7L4*	266540
	1200◆		-	-	CSC8L3*	258840	CSC8L4*	311530

- NOTES :**
1. While Ordering, Replace "*" by Current rating.
 2. ◆Spreader Terminals are included as standard packing.
 3. For Spreader Terminals reference & MRP, please refer page 43.

☒ non stockable items.



WiNbreak MCCB - CSC Series

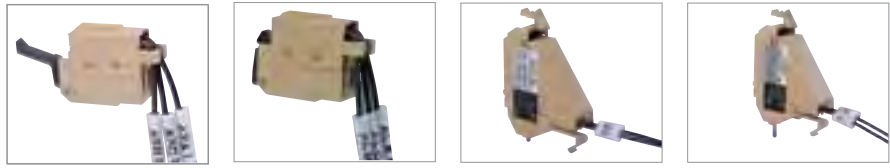

Accessories										[HSN Code: 8538]
Suitable for use on WB-CSC MCCBs	Shunt Trip (SHT)	MRP (₹)	Under Voltage Trip (UVT)	MRP (₹)	Auxiliary Switch (AX)	MRP (₹)	Alarm Switch (AL)	MRP (₹)	Combination Switch (AX + AL)	MRP (₹)
CSC1, CSC2, CSC3, CSC4	STC(...V)	2150	UVTC-(...V)	2520	AXWC-(*)	1500	ALWC-(*)	1370	XLC-(*)	3020
CSC5, CSC6	ST-6A(...V)	2870	UVT-6A(...V)	3510	ASW-6A	2730	ALSW-6A	2730	-	-
CSC7, CSC8	ST-7A(...V)	14070	UVT-7A(...V)	14070	ASW-7A	4980	ALSW-7A	4760	-	-



Rotary Handle							[HSN Code: 8538]
Suitable for use on WB-CSC MCCBs	Direct Rotary Handle	MRP (₹)	Direct Rotary Handle with Key Lock	MRP (₹)	Extended Rotary Handle	MRP (₹)	
CSC1, CSC2	DHC100	2650	☒ DHCK100	5840	CSE-35S■	1620	
					EHC100	4480	
CSC3	DHC125	2730	☒ DHCK125	6020	CSE-45S■	1620	
					EHC125	4740	
CSC4	DHC250	3230	☒ DHCK250	6360	EHC250	5240	
CSC5	N70S	3750	-	-	E70U	6090	
CSC6	-	-	-	-	E80U	6770	

NOTES:

1. Please replace "*" with R as MCCB left hand side position & T as MCCB right hand position.
2. Left Hand seat is not available in 2 Pole MCCB in Frame 1 & Frame 2
3. Rotary Handle for 2 Pole Frame 1 & Frame 2 is not available.
4. ■Conventional type

Selection UVT & Shunt				
Accessories	FRAME	AC	DC	AC/DC COMMON
UVT	1, 2, 3	AC 380-440V	-	AC/DC 24V
		AC 440-480V	-	AC/DC 48V
		-	-	AC/DC 100-110V
		-	-	AC/DC 200-220V
	4, 5	AC 380-440V	-	AC/DC 48V
		AC 440-480V	-	100-125VAC/100-110VDC
		-	-	AC 200-240V/ DC 200-220V
	6	-	-	100-110V
		-	-	125V
		-	-	200-220V
SHUNT	1, 2, 3	AC 380-450V	DC 12V	AC/DC 48-60V
		AC 440-500V	-	AC/DC 100-130V
		-	-	AC/DC 200-250V
	4, 5	AC 380-550V	-	AC/DC 24-48V
		-	-	AC 100-240V/ DC 100-220V
	6	100-110V	24V	-
		125V	48V	-
		200-220V	100-110V	-
		380-440V	125V	-
			480-550V	200-220V

☒ non stockable items.

Winbreak MCCB - CSC Series



Terminal Covers [HSN Code: 8538]						
Suitable for use on WB-CSC MCCBs	For Line/Load Side					
	2P Reference	MRP (₹)	3P Reference	MRP (₹)	4P Reference	MRP (₹)
CSC1, CSC2	TCS12	480	TCS13	630	TCS14	700
CSC3	TCS22	510	TCS23	900	TCS24	1040
CSC4	TCS33	1070	TCS33	1070	TCS34	1190



Mechanical Interlock [HSN Code: 8538]				
Suitable for use on MCCBs	Applied between two MCCBs			
	Reference 3 Pole	MRP (₹)	Reference 4 Pole	MRP (₹)
CSC5	MI43S	6230	MI44S	7760
CSC6	MI83S	7760	MI84S	9160



Spreader Terminals [HSN Code: 8538]						
Suitable for use on MCCBs	Pole	Current Rating (A)	Reference	MRP (₹)	MOQ	
CSC1, CSC2, CSC3	2 Pole	15, 20, 30, 40, 50, 60	CSET1022	150	Set of 2	
CSC1, CSC2, CSC3	2 Pole	75, 100, 125	CSET1022C	170	Set of 2	
CSC1, CSC2, CSC3	3Pole	15, 20, 30, 40, 50, 60	CSET1033	200	Set of 3	
CSC1, CSC2, CSC3	3Pole	75, 100, 125	CSET1033C	290	Set of 3	
CSC1, CSC2, CSC3	4 Pole	15, 20, 30, 40, 50, 60	CSET1044	330	Set of 4	
CSC1, CSC2, CSC3	4 Pole	75, 100, 125	CSET1044C	400	Set of 4	
CSC4	2 Pole	150, 175, 200	CSET2022	330	Set of 2	
CSC4	2 Pole	250	CSET2502-ST	420	Set of 2	
CSC4	3 Pole	150, 175, 200	CSET2033	480	Set of 3	
CSC4	3 Pole	250	CSET2503-ST	780	Set of 3	
CSC4	4 Pole	150, 175, 200	CSET2044	720	Set of 4	
CSC4	4 Pole	250	CSET2504-ST	1020	Set of 4	
CSC5	3 Pole	300, 350, 400	CSET4033	3440	Set of 3	
CSC5	4 Pole	300, 350, 400	CSET4044	3490	Set of 4	
CSC6	3 Pole	500, 630, 700, 800	CSET8033	3410	Set of 3	
CSC6	4 Pole	500, 630, 700, 800	CSET8044	4150	Set of 4	



SS Enclosure for WB MCCB [HSN Code: 8538]				
Size	Suitable for use on MCCBs	3 Pole Reference*	4 Pole Reference*	MRP (₹)
Frame 1	CSC1, CSC2	CS-CNM0100020	-	3980
Frame 2	CSC3	CS-CNM0100021	-	4010
Frame 3	CSC4	CS-CNM0100021	-	4010
Frame 4	CSC5	ENCL-250-400AF3	ENCL-250-400AF4	6230
Frame 5	CSC6	CS-CNM0100203	-	10450
Frame 6	CSC7, CSC8	CS-CNM0100204	-	11640

NOTES:

- *Reference code is for Enclosure only (without MCCB)
- For placing an order for MCCB along with Enclosure, please apply Prefix **E-** before MCCB Reference Code. For Price please contact nearest Branch Office.

 non stockable items.

Switch Disconnectors at a Glance

Non Modular Range



D Type



K Type



NM Type

Modular Range



DM Type



K Type



P Type



Switch Disconnector Fuse Unit

Switch Disconnector Fuse Unit (without Fuse Links)

- Conforms to IS/IEC 60947-3
- Range: 32-800A, 415V AC 50Hz
- Door Interlock and Padlock facility
- Version: 2P / TP / TPN / 4P
- Modular Construction
- Positive Isolation
- Suitable for DIN & Bolted HRC Fuse Links



[HSN Code: 8537]

Size	Rating Amps	Pole	CSSDF in Open Execution				CSSDF in Sheet Steel Enclosure				Recommended Fuse Links Type (IEC Size)	
			Reference	MRP (₹)	Reference	MRP (₹)	Reference	MRP (₹)	Reference	MRP (₹)	DIN	BS
			DIN		BS		DIN		BS			
Frame 1	32A	2P	CSSDF32D2	2470	CSSDF32B2	3000					CDFL00 32	CTIA-32 (A2)
		TP	CSSDF32D3	2950	CSSDF32B3	3080	☒E-CSSDF32D3	5660	E-CSSDF32B3	5880		
		TPN	CSSDF32D3N	3150	CSSDF32B3N	3160	E-CSSDF32D3N	5880	E-CSSDF32B3N	5990		
		4P	☒CSSDF32D4FN	3630	☒CSSDF32B4FN	3420	E-CSSDF32D4FN	6410	☒E-CSSDF32B4FN	6500		
Frame 1	63A	2P	CSSDF63D2	3630	CSSDF63B2	3480					CDFL00 63	CSTIS-63 (A3)
		TP	CSSDF63D3	3790	CSSDF63B3	3740	☒E-CSSDF63D3	6690	E-CSSDF63B3	6750		
		TPN	CSSDF63D3N	3850	CSSDF63B3N	4020	E-CSSDF63D3N	7240	E-CSSDF63B3N	7350		
		4P	CSSDF63D4FN	4230	CSSDF63B4FN	4370	E-CSSDF63D4FN	7530	☒E-CSSDF63B4FN	7550		
Frame 2	100A	2P	CSSDF100D2	6300	CSSDF100B2	7270					CSDFL00 100	CTCP-100 (A4)
		TP	CSSDF100D3	7620	CSSDF100B3	8400	E-CSSDF100D3	11210	E-CSSDF100B3	11470		
		TPN	CSSDF100D3N	8150	CSSDF100B3N	8550	E-CSSDF100D3N	11910	E-CSSDF100B3N	11570		
		4P	CSSDF100D4FN	9600	☒CSSDF100B4FN	10150	E-CSSDF100D4FN	13550	☒E-CSSDF100B4FN	14130		
Frame 2	125A	2P	CSSDF125D2	7630	CSSDF125B2	7750					CSDFL00 125	CTCP-125 (A4)
		TP	CSSDF125D3	8150	☒CSSDF125B3	8460	☒E-CSSDF125D3	12860	E-CSSDF125B3	12690		
		TPN	CSSDF125D3N	8960	CSSDF125B3N	9150	E-CSSDF125D3N	13370	E-CSSDF125B3N	14300		
		4P	CSSDF125D4FN	11120	CSSDF125B4FN	11110	☒E-CSSDF125D4FN	14610	☒E-CSSDF125B4FN	15160		
Frame 2	160A	2P	☒CSSDF160D2	9300	CSSDF160B2	9600					CSDFL00 160	CTF-160 (B2)
		TP	CSSDF160D3	10340	☒CSSDF160B3	10680	E-CSSDF160D3	14550	E-CSSDF160B3	14720		
		TPN	CSSDF160D3N	10530	CSSDF160B3N	11780	E-CSSDF160D3N	15670	☒E-CSSDF160B3N	16230		
		4P	☒CSSDF160D4FN	12550	☒CSSDF160B4FN	13890	E-CSSDF160D4FN	19480	E-CSSDF160B4FN	21490		
Frame 3	200A	2P	CSSDF200D2	11360	CSSDF200B2	11950					CDFL1 200 / CSDFL1 200	CTF-200 (B2)
		TP	CSSDF200D3	12300	☒CSSDF200B3	12890	☒E-CSSDF200D3	16760	E-CSSDF200B3	19950		
		TPN	CSSDF200D3N	13830	CSSDF200B3N	13830	E-CSSDF200D3N	18140	E-CSSDF200B3N	21000		
		4P	CSSDF200D4FN	14690	CSSDF200B4FN	15820	☒E-CSSDF200D4FN	20980	E-CSSDF200B4FN	22070		
Frame 3	250A	2P	CSSDF250D2	12900	☒CSSDF250B2	13290					CDFL1 250/ CSDFL1 250	CTKF (B3)
		TP	CSSDF250D3	14920	CSSDF250B3	15330	☒E-CSSDF250D3	19470	E-CSSDF250B3	21000		
		TPN	CSSDF250D3N	14990	CSSDF250B3N	15510	E-CSSDF250D3N	20250	E-CSSDF250B3N	21620		
		4P	CSSDF250D4FN	16820	CSSDF250B4FN	17250	☒E-CSSDF250D4FN	23570	E-CSSDF250B4FN	24090		
Frame 3	315A	2P	CSSDF315D2	15160	CSSDF315B2	15910					CDFL2 315/ CSDFL2 315	CTKF-315 (B3)
		TP	CSSDF315D3	19380	CSSDF315B3	19620	E-CSSDF315D3	24220	E-CSSDF315B3	25440		
		TPN	CSSDF315D3N	19950	CSSDF315B3N	20020	E-CSSDF315D3N	24470	E-CSSDF315B3N	25650		
		4P		23010	CSSDF315B4FN	21750	☒E-	32060	E-CSSDF315B4FN	34620		
Frame 3	400A	2P	☒CSSDF400D2	19550	CSSDF400B2	20300					CDFL2 400/ CSDFL2 400	CTMF-400 (B4)
		TP	CSSDF400D3	23190	☒CSSDF400B3	24360	☒E-CSSDF400D3	29600	E-CSSDF400B3	30870		
		TPN	CSSDF400D3N	23890	CSSDF400B3N	24640	E-CSSDF400D3N	29820	E-CSSDF400B3N	31080		
		4P	CSSDF400D4FN	26660	CSSDF400B4FN	28880	☒E-CSSDF400D4FN	33790	E-CSSDF400B4FN	37220		
Frame 4	630A	2P	CSSDF630D2	33090	☒CSSDF630B2	29470					CDFL3 630	CTTM-630 (C2)
		TP	CSSDF630D3	40650	☒CSSDF630B3	41820	E-CSSDF630D3	43560	E-CSSDF630B3	48300		
		TPN	CSSDF630D3N	42000	CSSDF630B3N	42350	E-CSSDF630D3N	45790	☒E-CSSDF630B3N	52160		
		4P	CSSDF630D4FN	46520	CSSDF630B4FN	49910	☒E-CSSDF630D4FN	55810	E-CSSDF630B4FN	59380		
Frame 4	800A	2P	CSSDF800D2	44180	CSSDF800B2	41100					-	CTLM-800 (C3)
		TP	☒CSSDF800D3	48100	CSSDF800B3	52080	E-CSSDF800D3		E-CSSDF800B3			
		TPN	CSSDF800D3N	49350	CSSDF800B3N	54600	☒E-CSSDF800D3N	POR	☒E-CSSDF800B3N	POR		
		4P	☒CSSDF800D4FN	56620	CSSDF800B4FN	61690	E-CSSDF800D4FN		E-CSSDF800B4FN			

☒ non stockable items.

Accessories Switch Disconnecter Fuse Unit



Key Interlocks (3 Locks - 2 Keys)		[HSN Code: 8538]
For Switch Type	Reference	MRP (₹)
CSSDF 32A - 160A	☒ CSSDFZW-16	4970
CSSDF 200A - 800A	CSSDFZW-5	5580



Castle Key Locks		[HSN Code: 8538]
CSSDF 32A - 160A	CSSDFZW-15	6370
CSSDF 200A - 800A	CSSDFZW-4	6700



Auxiliary Contacts		[HSN Code: 8538]
1 NO + 1 NC CSSDF 32A - 63A for 3P	CSSDFZX46	850
2 NO + 2 NC CSSDF 32A - 63A for 3P	CSSDFZX32	1560
1 NO + 1 NC CSSDF 32A - 63A for 2P & 4P	CSSDFZX46B	850
2 NO + 2 NC CSSDF 32A - 63A for 2P & 4P	☒ CSSDFZX32B	1560
1 NO + 1 NC CSSDF 100A - 160A	CSSDFZX1	850
2 NO + 2 NC CSSDF 100A - 160A	☒ CSSDFZX16	1560
1 NO + 1 NC CSSDF 200A - 400A	CSSDFZX33	1020
2 NO + 2 NC CSSDF 200A - 400A	CSSDFZX34	1890
1 NO + 1 NC CSSDF 630A - 800A	CSSDFZX35	1020
2 NO + 2 NC CSSDF 630A - 800A	☒ CSSDFZX36	1560



Handle Mounting Kit (for independent mounting of O/E Switches)		[HSN Code: 8538]
CSSDF 200A - 400A	HMK-1-2	2170
CSSDF 630A - 800A	HMK-3-2	2290



Extended Terminals						[HSN Code: 8538]
32A-63A	TPN	ET-323	560	4P	ET-324	670
100A-160A	TPN	ET-327	1400	4P	ET-328	1990
200A-400A	TPN	ET-329	4080	4P	ET-330	4970



Spare Handle		[HSN Code: 8538]
CSSDF 32A-160A (Moulded)	CSWH80S6	890
CSSDF 200A-400A (Moulded)	CSWH145S12	1540
CSSDF 630A-800A (Moulded)	CSWH220S12	1960

Spare Handle Shaft		[HSN Code: 8538]
CSSDF 32A-160A	CSP6x165	400
CSSDF 200A-800A	CSP12x255	690



Spare Neutral Links		[HSN Code: 8538]
CSSDF 32A-63A	CSSDFZX87	540
CSSDF 100A-160A	CSSDFZX86	660
CSSDF 200A-400A	CSSDFZX85	1130
CSSDF 630A-800A	☒ CSSDFZX88	1300

Spare Poles (Price per Pole)			[HSN Code: 8538]
Rating (Amps)	Reference		MRP (₹)
	DIN	BS	
32	☒ CSSDF-SP-32D	CSSDF-SP-32B	1530
63	CSSDF-SP-63D	CSSDF-SP-63B	1910
100	CSSDF-SP-100D	CSSDF-SP-100B	3720
125	☒ CSSDF-SP-125D	CSSDF-SP-125B	4060
160	☒ CSSDF-SP-160D	CSSDF-SP-160B	4750
200	☒ CSSDF-SP-200D	CSSDF-SP-200B	5510
250	CSSDF-SP-250D	CSSDF-SP-250B	7520
315	CSSDF-SP-315D	CSSDF-SP-315B	8420
400	☒ CSSDF-SP-400D	CSSDF-SP-400B	10810
630	☒ CSSDF-SP-630D	CSSDF-SP-630B	15380
800	CSSDF-SP-800D	☒ CSSDF-SP-800B	18760

☒ non stockable items.



Switch Disconnecter

Switch Disconnectors (Load Break Switches)

- Conforms to IS/IEC 60947-3
- Range: 25A-400A, 415V AC 50Hz
- Version: TP / 4P
- Compact Construction
- Door Interlock and Padlock facility
- Positive Isolation



[HSN Code: 8536]

Size	Rating Amps	Pole	CSSD In Open Execution		In Sheet Steel Enclosure		
			Reference	MRP (₹)	Reference	MRP (₹)	
D-Series	Frame 1	25	3	CSSD25D3	2120	☒E-CSSD25D3	4620
			4	☒CSSD25D4	2800	E-CSSD25D4	5030
	Frame 1	40	3	CSSD40D3	2270	E-CSSD40D3	5320
			4	CSSD40D4	4410	☒E-CSSD40D4	5810
	Frame 2	63	3	CSSD63K3	3010	☒E-CSSD63K3	6340
	Frame 3		4	CSSD63D4	4810	☒E-CSSD63D4	7610
	Frame 3	125	3	CSSD125D3	6760	E-CSSD125D3	10640
Frame 3	4		CSSD125D4	8220	☒E-CSSD125D4	11810	
NM-Series	Frame 1	125	3	CSSD125NM3	7930	E-CSSD125NM3	11720
			4	CSSD125NM4	9770	E-CSSD125NM4	14460
	Frame 1	160	3	☒CSSD160NM3	8840	E-CSSD160NM3	13080
			4	☒CSSD160NM4	10520	E-CSSD160NM4	15590
	Frame 1	200	3	☒CSSD200NM3	11290	E-CSSD200NM3	14670
			4	CSSD200NM4	14640	E-CSSD200NM4	19040
	Frame 1	250	3	CSSD250NM3	11420	E-CSSD250NM3	16910
			4	CSSD250NM4	15840	☒E-CSSD250NM4	23470
	☀Frame 2	315	3	CSSD315NM3	14890	E-CSSD315NM3	POR
			4	CSSD315NM4	16070	E-CSSD315NM4	
☀Frame 2	400	3	CSSD400NM3	17840	E-CSSD400NM3		
		4	CSSD400NM4	21640	E-CSSD400NM4		

NOTE:

1. Rotary Handle with door defeat Mechanism / Pistol grip handle is available only for 25-63A.
2. Switch Disconnecter with Direct Handle and Extended Terminals are also available. Please contact nearest Branch Office for prices.
3. ☒non stockable items.



Switch Disconnecter

Switch Disconnectors (Load Break Switches)

- Conforms to IS/IEC 60947-3
- Range: 125A-3150A, 415V, 50Hz
- Version: 2P, 3P, 4P
- Modular construction
- Positive Isolation
- Door Interlock and Padlock facility ■



Size	Rating Amps	Pole	CSSD In Open Execution [HSN Code: 8536]		In Sheet Steel Enclosure [HSN Code: 8536]			
			Reference	MRP (₹)	Reference	MRP (₹)		
DM-Series	Frame 4	125	3	CSSD125DM3	8890	E-CSSD125DM3	12000	
		4	CSSD125DM4	11010	☒E-CSSD125DM4	14860		
	Frame 5	160	3	CSSD160DM3	10170	E-CSSD160DM3	13430	
		4	CSSD160DM4	11750	E-CSSD160DM4	16150		
	Frame 5	200	3	CSSD200DM3	12600	E-CSSD200DM3	17150	
			4	CSSD200DM4	18730	E-CSSD200DM4	22290	
	Frame 5	250	3	CSSD250DM3	15370	E-CSSD250DM3	20250	
			4	CSSD250DM4	19000	E-CSSD250DM4	23690	
	Frame 5	315	3	CSSD315DM3	17840	E-CSSD315DM3	22160	
			4	CSSD315DM4	21690	E-CSSD315DM4	25760	
	Frame 5	400	3	CSSD400DM3	21620	E-CSSD400DM3	26260	
			4	CSSD400DM4	25220	E-CSSD400DM4	31110	
	K-Series	Frame 6	630	3	CSSD630K3	32040	E-CSSD630K3	37510
			4	CSSD630K4	37580	E-CSSD630K4	43580	
Frame 6		800	3	CSSD800K3	37820	E-CSSD800K3	43870	
			4	CSSD800K4	41700	E-CSSD800K4	52770	
P-Series	Frame 7	1000	3	☒CSSD1000P3	43130	E-CSSD1000P3	70910	
		4	CSSD1000P4	61490	E-CSSD1000P4	93270		
	Frame 7	1250	3	☒CSSD1250P3	63910	E-CSSD1250P3	86910	
			4	☒CSSD1250P4	84450	E-CSSD1250P4	114320	
	Frame 7	1600	3	☒CSSD1600P3	80030	E-CSSD1600P3	108840	
			4	☒CSSD1600P4	106700	E-CSSD1600P4	145110	
	Frame 8	2000	3	CSSD2000P3	160140	E-CSSD2000P3	210150	
			4	CSSD2000P4	181920	E-CSSD2000P4	234740	
	Frame 8	2500	3	CSSD2500P3	179110	E-CSSD2500P3	233220	
			4	CSSD2500P4	203550	E-CSSD2500P4	260550	
	Frame 8	3150	3	CSSD3150P3	226030	E-CSSD3150P3	312750	
			4	CSSD3150P4	256850	E-CSSD3150P4	363180	

☒ non stockable items.

NOTES:

'K' series from 1000A to 3150A in open execution is also available on special request for retrofit orders only. For price, please contact nearest Branch Office.
 Handle colour: Red Knob and Yellow Base (standard) Black Base and Knob on request. ■ upto 800A



Switch Disconnecter

Switch Disconnectors (Moulded construction)



Accessories		[HSN Code: 8538]		
For Switch Type	Reference	MRP (₹)		
Key Interlocks (3 Locks - 2 Keys)				
CSSD 125A-160A	CSSDZW - 16	6680		
CSSD 200A-3150A	CSSDZW - 5			
Castle Key Locks				
CSSD 25A-160A	CSSDZW - 15	5620		
CSSD 200A-3150A	CSSDZW - 4			
Auxiliary Contacts				
1 NO+1 NC CSSD 25A-40A	3	<input checked="" type="checkbox"/> CSSDZX49	880	
2 NO+2 NC CSSD 25A-40A	3	<input checked="" type="checkbox"/> CSSDZX50	1650	
1 NO+1 NC CSSD 25A-40A	4	CSSDZX87	880	
2 NO+2 NC CSSD 25A-40A	4	<input checked="" type="checkbox"/> CSSDZX88	1650	
1 NO+1 NC CSSD 63A	3	<input checked="" type="checkbox"/> CSSDZX79	880	
2 NO+2 NC CSSD 63A	3	<input checked="" type="checkbox"/> CSSDZX80	1650	
1 NO+1 NC CSSD 125A	3	<input checked="" type="checkbox"/> CSSDZX52	880	
2 NO+2 NC CSSD 125A	3	<input checked="" type="checkbox"/> CSSDZX53	1650	
1 NO+1 NC CSSD 63A-125A	4	<input checked="" type="checkbox"/> CSSDZX55	880	
2 NO+2 NC CSSD 63A-125A	4	<input checked="" type="checkbox"/> CSSDZX56	1650	
1 NO+1 NC CSSD 125A-160A (DM)	3/4	<input checked="" type="checkbox"/> CSSDZX1	1650	
2 NO+2 NC CSSD 125A-160A (DM)	3/4	CSSDZX16		
1 NO+1 NC CSSD 200A-400A (DM)	3/4	CSSDZX37		
2 NO+2 NC CSSD 200A-400A (DM)	3/4	CSSDZX38		
1 NO+1 NC CSSD 630A-800A	3/4	<input checked="" type="checkbox"/> CSSDZX33		
2 NO+2 NC CSSD 630A-800A	3/4	<input checked="" type="checkbox"/> CSSDZX34		
1 NO+1 NC CSSD 1000A-3150A	3/4	CSSDZX35		
2 NO+2 NC CSSD 1000A-3150A	3/4	<input checked="" type="checkbox"/> CSSDZX36		
Handle Mounting Kit (for independent mounting of O/E Switches)				
CSSD 200A-400A (Compact Series)	HMK-2			2180
CSSD 630A-800A	HMK-1-1		2200	
CSSD 1000A-1600A	HMK-3-1		2350	
Extended Terminals				
125A	TPN	ET-325 710	4P ET-326 770	
100A-160A	TPN	ET-327 1270	4P ET-328 1810	
200A-400A	TPN	ET-329 3710	4P ET-330 4520	
Rotary Knob Handles				
CSSD 25A-125A (Moulded-Red/Yellow)	<input checked="" type="checkbox"/> CSSDZX108		540	
CSSD 25A-125A (Moulded-Black)	CSSDZX111BL			
Switch Handles				
CSSD 200A-800A (Moulded)	CSWH145S12		1540	
CSSD 1000A-1600A (Moulded)	CSWH220S12		1960	
CSSD 2500A-3150A (Metallic)	CSDA8		2310	
CSSD 125A-160A (Moulded)	CSWH80S6		890	
CSSD 200A-315A (Moulded)	<input checked="" type="checkbox"/> CSWH80S8			
Switch Handle Shaft				
CSSD 25A-125A	<input checked="" type="checkbox"/> CSP5X70		610	
CSSD 125A-160A (DM)	CAP6X165		400	
CSSD 200A-400A (DM)	<input checked="" type="checkbox"/> CSP8X240			
CSSD 630A-1600A	CSP12X255		690	
CSSD 2500A-3150A	CSP12X325		840	
Switch Poles (Price per Pole)				
125A	CSSD-SP-125DM		2110	
160A	CSSD-SP-160DM		2110	
200A	<input checked="" type="checkbox"/> CSSD-SP200DM		2810	
250A	<input checked="" type="checkbox"/> CSSD-SP250DM		3750	
315A	<input checked="" type="checkbox"/> CSSD-SP315DM		5460	
400A	<input checked="" type="checkbox"/> CSSD-SP400DM		10530	
630A	CSSD-SP630K		12070	
800A	<input checked="" type="checkbox"/> CSSD-SP800K		15910	
1000A	CSSD-SP1000P		24130	
1250A	CSSD-SP1250P		28780	
1600A	CSSD-SP1600P		30230	

non stockable items.



Changeover Switch

On Load Changeover Switches

- Conforms to IS/IEC 60947-3
- Range: 63A–3150A, 415V, 50Hz
- Version: 4P
- Modular construction
- Positive Isolation
- Door Interlock and Padlock facility ■



In Open Execution [HSN Code: 8536]					
Size	Rating (Amps)	Pole	Reference	MRP (₹)	
NM-Series	Frame 1	63	4	CSCS63NM4CO	7480
	Frame 1	100	4	CSCS100NM4CO	9930
	Frame 2	125	4	CSCS125NM4CO	14510
	Frame 2	160	4	CSCS160NM4CO	15950
	Frame 2	200	4	CSCS200NM4CO	19180
	Frame 2	250	4	CSCS250NM4CO	28790
DM-Series	Frame 2	315	4	CSCS315DM4CO	30010
	Frame 2	400	4	CSCS400DM4CO	43970
K-Series	Frame 3	630	4	CSCS630K4CO	51310
	Frame 3	800	4	CSCS800K4CO	73000
P-Series	Frame 4	1000	4	<input checked="" type="checkbox"/> CSCS1000P4CO	129680
	Frame 4	1250	4	<input checked="" type="checkbox"/> CSCS1250P4CO	175320
	Frame 4	1600	4	<input checked="" type="checkbox"/> CSCS1600P4CO	222050
	Frame 5	2000	4	<input checked="" type="checkbox"/> CSCS2000P4CO	320870
	Frame 5	2500	4	<input checked="" type="checkbox"/> CSCS2500P4CO	425080
	Frame 5	3150	4	<input checked="" type="checkbox"/> CSCS3150P4CO	585830

In Sheet Steel Enclosure [HSN Code: 8536]					
Size	Rating (Amps)	Pole	Reference	MRP (₹)	
NM-Series	Frame 1	63	4	E-CSCS63NM4CO	10520
	Frame 1	100	4	E-CSCS100NM4CO	13240
	Frame 2	125	4	E-CSCS125NM4CO	19300
	Frame 2	160	4	E-CSCS160NM4CO	21010
	Frame 2	200	4	E-CSCS200NM4CO	24310
	Frame 2	250	4	E-CSCS250NM4CO	36760
DM-Series	Frame 2	315	4	E-CSCS315DM4CO	37980
	Frame 2	400	4	E-CSCS400DM4CO	55930
K-Series	Frame 3	630	4	E-CSCS630K4CO	64400
	Frame 3	800	4	E-CSCS800K4CO	96050
P-Series	Frame 4	1000	4	<input checked="" type="checkbox"/> E-CSCS1000P4CO	167330
	Frame 4	1250	4	<input checked="" type="checkbox"/> E-CSCS1250P4CO	217110
	Frame 4	1600	4	<input checked="" type="checkbox"/> E-CSCS1600P4CO	282370
	Frame 5	2000	4	<input checked="" type="checkbox"/> E-CSCS2000P4CO	398570
	Frame 5	2500	4	<input checked="" type="checkbox"/> E-CSCS2500P4CO	510000
	Frame 5	3150	4	<input checked="" type="checkbox"/> E-CSCS3150P4CO	691280

non stockable items.

NOTES:

'K' series from 1000A to 3150A in open execution is also available on special request for retrofit orders only. For price, please contact nearest Branch Office.

- Upto 800A



Changeover Switch

Accessories [HSN Code: 8538]		
Auxiliary Contacts for NM Type Changeover		
Description	Reference	MRP (₹)
1NO +1NC for 63~100A	CSCONM1AUX10	750
1NO +1NC for 125~250A	CSCONM2AUX10	

Direct handle Mounting Kit for NM Type Changeover [HSN Code: 8538]		
Rating (Amps)	Reference	MRP (₹)
63~100A	☒CSCONM1HMB	610
125~250A	☒CSCONM2HMB	750

Switch Handle Shaft for NM Type Changeover [HSN Code: 8538]		
Rating (Amps)	Reference	MRP (₹)
63~100A	☒CSPNM18X80	430
125~250A	CSPNM28X110	560

Handle Sub Assembly for NM Type Changeover [HSN Code: 8538]		
Rating (Amps)	Reference	MRP (₹)
63~100A	CSCONM1H80S8	840
125~250A	☒CSCONM2H145S8	1210

Bypass Switches

LT Bypass Switch complete with Handle Assembly having Door Interlock and Padlocking arrangement.

In Open Execution				[HSN Code: 8536]
Size	Rating (Amps)	Pole	Reference	MRP (₹)
Frame 1	63	4	CSBS63DM4	20110
	80	4	CSBS80DM4	24570
	100	4	CSBS100DM4	25620
	125	4	CSBS125DM4	28190
	160	4	CSBS160DM4	33320
Frame 2	200	4	CSBS200DM4	34060
	250	4	CSBS250DM4	51840
	315	4	CSBS315DM4	53810
	400	4	CSBS400K4	76000
Frame 3	630	4	CSBS630K4	90920
	800	4	CSBS800K4	114050
Frame 4	1000	4	CSBS1000P4	212700
	1250	4	CSBS1250P4	292120
	1600	4	CSBS1600P4	391950

In Sheet Steel Enclosure				[HSN Code: 8536]
Size	Rating (Amps)	Pole	Reference	MRP (₹)
Frame 1	63	4	E-CSBS63DM4	28630
	80	4	E-CSBS80DM4	30660
	100	4	E-CSBS100DM4	31460
	125	4	E-CSBS125DM4	35850
	160	4	E-CSBS160DM4	38690
Frame 2	200	4	E-CSBS200DM4	43750
	250	4	E-CSBS250DM4	62900
	315	4	E-CSBS315DM4	67280
	400	4	E-CSBS400K4	94150
Frame 3	630	4	E-CSBS630K4	107640
	800	4	E-CSBS800K4	159460
Frame 4	1000	4	E-CSBS1000P4	262660
	1250	4	E-CSBS1250P4	354600
	1600	4	E-CSBS1600P4	477140

NOTES:

'K' series from 1000A to 1600A is also available on request for retrofit only. For price, please contact nearest Branch Office. Door interlock & Pad locking arrangements are available upto 800A

Bypass Switch application				
Table of Operation				
Handle	Switch-I	Switch-II	Switch-III	Remarks
Position-I	ON	OFF	ON	Regulated Supply to Load
Position-O	OFF	OFF	OFF	No Supply, Load as well as Regulator Isolated form incoming source
Position-II	OFF	ON	OFF	Direct Supply, Regulator By-passed & Isolated

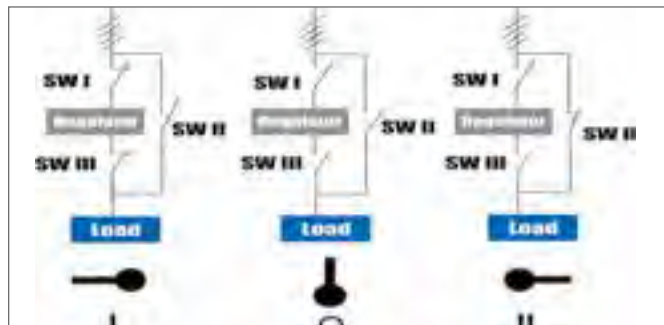

Bypass Switches

LT Bypass Switch complete with Handle Assembly having Door Interlock and Padlocking arrangement.

Accessories for Changeover -Type DM/K/P

Auxiliary Contacts				[HSN Code: 8538]
Contacts Configuration	For Switch Type	Qty./Switch	Reference	MRP (₹)
1NO+1NC	CSCS/CSBS 63A-160A Upper CSCF 125A-160A	1	☒CSCSZX1-U	830
1NO+1NC	CSCS/CSBS 63A-160A Lower CSCF 125A-160A	1	☒CSCSZX1-L	830
2NO+2NC	CSCS/CSBS 63A-160A Upper CSCF 125A-160A	1	☒CSCSZX3-U	1610
2NO+2NC	CSCS/CSBS 63A-160A Lower CSCF 125A-160A	1	CSCSZX3-L	1610
1NO+1NC	CSCS/CSBS 200A-1600A CSCF 200A-800A	2	CSCSZX2	1660
2NO+2NC	CSCS/CSBS 200A-1600A CSCF 200A-800A	2	CSCSZX4	3220

NOTES: If changeovers switch is required with Auxiliary contacts, please order the same separately. Prices listed are for the pair of auxiliary contacts, if applicable.

Spare Poles (Price per Pole)				[HSN Code: 8538]
Rating (Amps)	Type	Reference	MRP (₹)	
63	CSCS/CSBS	CSSD-SP-63DM	1840	
80	CSCS/CSBS	CSSD-SP-80DM	1890	
100	CSCS/CSBS	CSSD-SP-100DM	2050	
125	CSCS/CSBS/CSCF	CSSD-SP-125DM	2120	
160	CSCS/CSBS/CSCF	CSSD-SP-160DM	2120	
200	CSCS/CSBS/CSCF	CSSD-SP200DM	2830	
250	CSCS/CSBS/CSCF	CSSD-SP250DM	3800	
315	CSCS/CSBS/CSCF	CSSD-SP315DM	5510	
400	CSCS/CSBS/CSCF	CSCS-SP400DM	10600	
630	CSCS/CSBS/CSCF	CSCS-SP630K	12030	
800	CSCS/CSBS/CSCF	CSCS-SP800K	16020	
1000	CSCS/CSBS	☒CSCS-SP1000P	24090	
1250	CSCS/CSBS	☒CSCS-SP1250P	30160	
1600	CSCS/CSBS	☒CSCS-SP1600P	34730	

NOTES: For one changeover of 4 pole, 8 Nos of sparepoles are required.

Spare Handle			[HSN Code: 8538]
Rating (Amps)	Reference	MRP (₹)	
CSCS/CSBS 63-315A/CSCF125-315A	CCOH145S8	1650	
CSCS/CSBS 400A-1600A/CSCF400-800A	CCOH220S12	1670	
CSCS 2000A-3150A (Metallic)	CSDA6	1910	

Spare Handle Shaft			[HSN Code: 8538]
Type	Reference	MRP (₹)	
CSCS 63-315A CSBS 63-315A CSCF125-315A	CSP8X200	450	
CSCS 400A-1600A	CSP12X205	510	
CSCS 2000A-3150A CSBS 400A-1600A CSCF 400A-1600A	☒CSP12X305	830	

☒non stockable items.



SDF Changeover

Switch Disconnecter Fuse Changeover (Conventional Type / Side-by-Side)

LT Heavy Duty 4 Pole Changeover Switch Disconnecter Fuse unit comprising of two Switches, 32A - 800A, 415V, 50Hz mounted on common chasis complete with Mechanical Interlock and Handle Assembly having Door Interlock & Padlocking arrangements.

CSSDF in Open Execution, 4 Pole [HSN Code: 8536]				
Size	Rating (Amps)	Reference		MRP (₹)
		DIN	BIS	
Frame 1	32	CSSDF32D4CO	CSSDF32B4CO	POR
	63	CSSDF63D4CO	CSSDF63B4CO	
Frame 2	100	CSSDF100D4CO	CSSDF100B4CO	
	125	CSSDF125D4CO	CSSDF125B4CO	
	160	CSSDF160D4CO	CSSDF160B4CO	
Frame 3	200	☒CSSDF200D4CO	CSSDF200B4CO	
	250	☒CSSDF250D4CO	CSSDF250B4CO	
	315	☒CSSDF315D4CO	CSSDF315B4CO	
Frame 4	400	☒CSSDF400D4CO	CSSDF400B4CO	
	630	☒CSSDF630D4CO	CSSDF630B4CO	
Frame 4	800	-	CSSDF800B4CO	

Load Break Changeover Conventional Type / Side-by-Side)

LT Heavy Duty 4 Pole Changeover Load Break Switch comprising of two Switches 25A - 3150A, 415V, 50Hz mounted on common chasis complete with Mechanical Interlock and Handle Assembly having Door Interlock and Padlocking arrangements.

CSSD in Open Execution, 4 Pole [HSN Code: 8536]			
Size	Rating (Amps)	Reference	MRP (₹)
Frame 1	25	CSSD25D4CO	POR
	40	CSSD40D4CO	
Frame 2	63	CSSD63D4CO	
Frame 3	125	☒CSSD125DM4CO	
	160	☒CSSD160DM4CO	
Frame 4	200	☒CSSD200DM4CO	
	250	☒CSSD250DM4CO	
	400	☒CSSD400DM4CO	
Frame 5	630	☒CSSD630K4CO	
	800	☒CSSD800K4CO	
Frame 6	1000	☒CSSD1000P4CO	
	1250	☒CSSD1250P4CO	
	1600	☒CSSD1600P4CO	
Frame 7	1800	☒CSSD1800P4CO	
	3150	☒CSSD3150P4CO	

NOTE:

- Shorting Links/Busbars NOT provides with open execution in conventional type Changeover Switches Enclosure Prices on request.
- 'K' series from 1000A to 3150A in open execution is also available on special request for retrofit jobs only. For price, please contact nearest Branch Office.

Off-Load Changeover Switches [HSN Code: 8536]				
Reference	Rating (Amps)	Pole	Rated Voltage	MRP (₹)
CSCSO32CO2	32	2	250 V	2560
CSCSO63CO2	63	2	250 V	5430
CSCSO32CO4	32	4	415 V	4220
CSCSO63CO4	63	4	415 V	8620
CSCSO100CO4	100	4	415 V	19130
CSCSO200CO4	200	4	415 V	27650
CSCSO315CO4	315	4	415 V	33850
CSCSO400CO4	400	4	415 V	37590

Accessories-Changeover Switches (CSSDF) [HSN Code: 8538]		
Spare Handles		
For Switch Type	Reference	MRP (₹)
CSSDF 32A - 160A (Moulded)	CCOH80S6	POR
CSSDF 200A - 400A (Moulded)	CCOH220S12	
CSSDF 630A - 800A (Metallic)	CSDA6	

Accessories-CSSDF Changeover Switches [HSN Code: 8538]		
Operating Mechanism		
For Switch Type	Reference	MRP (₹)
CSSDF 32A-160A	☒CSSDFZW1	POR
CSSDF 200A-400A	☒CSSDZW12/1	
CSSDF 630A-800A	CSSDZW12	

Accessories-Changeover Switch (CSSD) [HSN Code: 8538]		
Spare Handles		
For Switch Type	Reference	MRP (₹)
CSSD 25A-125A (Moulded)	CCOH00S6	POR
CSSD 200A-800A (Moulded)	CCOH220S12	
CSSD 1000A-3150A (Metallic)	CSDA6	

Operating Mechanism [HSN Code: 8538]		
For Switch Type	Reference	MRP (₹)
CSSD 25A - 40A	☒CSSDZW6	POR
CSSD 63A - 125A (DM type)	☒CSSDZW6/1	
CSSD 200A - 400A (DM type)	☒CSSDZW11A	
CSSD 400A - 800A (K type)	☒CSSDZW11	
CSSD 1000A - 3150A (P type)	☒CSSDZW12	

Switch Fuse Unit: Rewirable with Side Handle [HSN Code: 8536]				
Reference	Rating (Amps)	Pole	Rated Voltage	MRP (₹)
☒CSRW16P1NS	16	SPN	240 V	1020
☒CSRW32P1NS	32	SPN	240 V	2490
☒CSRW16P2S	16	DP	240 V	1040
CSRW32P2S	32	DP	240 V	2770
CSRW32P3NS	32	TPN	415V	4150
CSRW63P3NS	63	TPN	415V	8250
CSRW100P3NS	100	TPN	415V	16550
CSRW200P3NS	200	TPN	415V	22000



☒non stockable items.



RoHS
Compliant

CATS

Automatic Transfer Switch

Key Features:

- With inbuilt micro processor based AMF controller
- Protection against under/over voltage, Single phase missing
- External indication terminal output for Source healthy and load ON.
- Inbuilt fuse protection to avoid failure of AMF controller
- 3 Position isolation lock for Source I - Off - Source II
- Option for communication over WIFI
- Option for cloud connectivity for IOT applications.
- Fire alarm / external fault trip feature is provided

Applications:

- Airport and Railways
- IT Malls and Commercial buildings
- Automobile Industries
- Data Centre and Telecommunications
- Oil and Gas Industries
- Manufacturing Industry
- Healthcare
- Banking and Finance



Automatic Transfer Switch

Automatic Transfer Switch

- Confirms IEC-60947-6-1
- Range 40A-3200A
- Utilisation Category AC32B



Size	Rating	Pole	Reference	MRP (₹)
Frame-1	40A	4	CATS1F40A...	63650
	63A	4	CATS1F63A...	65130
Frame-2	100A	4	CATS2F100A...	68180
	125A	4	CATS2F125A...	72700
Frame-3	160A	4	CATS3F160A...	77980
Frame-4	200A	4	CATS4F200A...	104020
	250A	4	CATS4F250A...	111380
Frame-5	315A	4	CATS5F315A...	131340
	400A	4	CATS5F400A...	132920
	630A	4	CATS5F630A...	173050
Frame-6	800A	4	CATS6F800A...	POR
	1250A	4	CATS6F1250A...	POR
	1600A	4	CATS6F1600A...	POR
	2000A	4	CATS6F2000A...	POR
	2500A	4	CATS6F2500A...	POR
	3200A	4	CATS6F3200A...	POR

NOTE: While ordering replace ... with 'C' (Top Incoming, Bottom Outgoing) 'R' (Bottom Incoming, Top Outgoing)

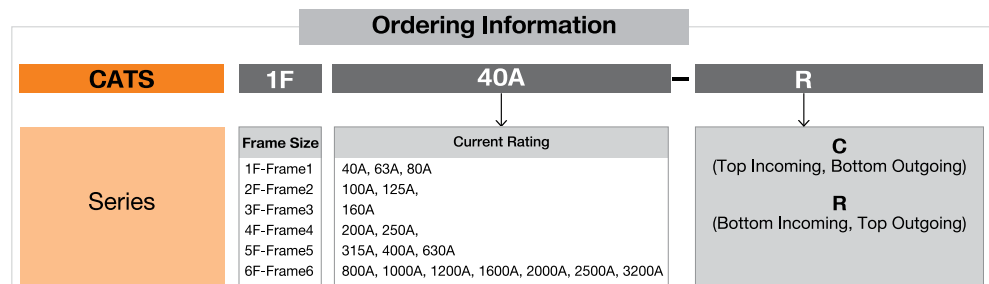



HRC Fuse Link, Fuse Base & Fuse Holder

Range: 2A~800A

- Conforms to IS 13703-Part 2
- Conforms to IEC 60269-Part 2
- Range: DIN type (6~630A), 500V, AC 50Hz, Bolted type (2~800A), 415V, AC 50Hz
- High breaking capacity: 80kA



DIN Type HRC Fuse Link				[HSN Code: 8536]
IS/IEC Size	In A	Reference	MRP (₹)	MOQ
00	6, 10, 16, 20, 25, 32, 35	CDFL00*	400	3
	40, 50, 63	CSDFL00*	400	
	80, 100	CSDFL00*	410	
	125, 160	CSDFL00*	420	
1	32, 35, 50, 63	CDFL01*	700	
	80, 100, 125	CDFL01*	760	
	160	CDFL01*	760	
	200	CSDFL1*	780	
	250	CSDFL1*	850	
2	100, 125	CDFL02*	1100	
	160, 200	CDFL02*	1120	
	250	CDFL02*	1120	
	315	CSDFL2*	1170	
	400	CSDFL2*	1230	
3	315, 400	CDFL03*	1560	
	500	CDFL3*	1880	
	630	CDFL3*	1880	

While ordering, replace "*" by current rating.



Fuse Bases for DIN Type Fuse Link (ISI Mark)				[HSN Code: 8536]
IS/IEC Size	In A	Reference	MRP (₹)	MOQ
00	160	CSDFB00	470	3
1	250	CSDFB1	860	
2	400	CSDFB2	1280	
3	630	CDFB3	2080	

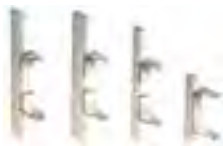

Solid Link				[HSN Code: 8536]
IS/IEC Size	In A	Reference	MRP (₹)	MOQ
00	160	CDSL00	590	3
1	250	CDSL1	780	
2	400	☒CDSL2	1070	
3	630	☒CDSL3	1310	

Bolted Type HRC Fuse Link



Off Set TAG Type				[HSN Code: 8536]
IS/IEC Size	Rating (Amps)	Reference	MRP (₹)	MOQ
A1	2, 4, 6, 8, 10, 12 & 16	CNIT*	95	20
	20, 25, & 32	CNIT*		
A2	4, 6,10,16, 20, 25 & 32	CSTIA*	140	20
A3	32, 40, 50 & 63	CSTIS*	200	10
A4	50, 63, 80, 100, 125	CTCP*	380	6
-	125, 160, 200	CTFP*	550	3

CNS (Off Set) clip in Type				[HSN Code: 8536]
IS/IEC Size	In A	Reference	MRP (₹)	MOQ
F1	2, 4, 6, 8, 10,12,16	CNS*	95	20
F1	20, 25, 32	CNS*	95	20

☒non stockable items.
MOQ-Minimum Order Quantity.

Bolted Type HRC Fuse Link



Central TAG (2 hole fixing) Type				[HSN Code: 8536]
IS/IEC Size	In A	Reference	MRP (₹)	MOQ
B1	80, 100	CTC*	410	6
B1	125	CTC*	410	
B2	125, 160, 200	CTF*	600	3
B3	250, 300, 315	CTKF*	860	1
B4	355, 400	CTMF*	1670	

☒ non stockable items. MOQ-Minimum Order Quantity.

HRC Fuse Link, Fuse Base & Fuse Holder



Central TAG (4 Hole Fixing) Type				[HSN Code: 8536]
IS/IEC Size	In A	Reference	MRP (₹)	MOQ
C1	355, 400	☒CTM*	1590	1
C2	450, 500	☒CTTM*	2630	
C2	630	CTTM*	3400	
C3	670, 710, 750, 800	☒CTLM*	3620	



Cylindrical HRC Fuse Link				[HSN Code: 8536]
IS/IEC Size	In A	Reference	MRP (₹)	MOQ
(14*51)	2, 4, 6, 8 & 10	CHF*	190	20
(14*51)	16, 20 & 25	CHF*	190	
(14*51)	32 & 40	CHF*	200	
(14*51)	50	CHF*	370	
(14*51)	63	CHF*	390	
(10*38)	2, 4, 6, 8, 10 & 16	CGF*	80	20
(10*38)	20 & 25	CGF*	85	
(10*38)	32	CGF*	85	



HRC Fuse Holder for Bolted Type Fuse Link								[HSN Code: 8536]
IS/IEC Size	In A	Reference	MRP (₹)	MOQ	Reference	MRP (₹)	MOQ	
F1	20	CNS20HN	210	10				
F1	32	CNS32H	240	10	-	-	-	
A2	32	CSM32HN	430	10				
A3	63	CSM63HN	500	5				
A4	100	-	-	-	CSM100H*	1470	3	
A4	100	-	-	-	CSM100B*	1650	3	

* H-Both side cable B-Top busbar & bottom cable



Fuse Holder for Cylindrical HRC Fuse Link				[HSN Code: 8536]
IS/IEC Size	In A	Reference	MRP (₹)	MOQ
14 x 51	32	CHO32R	230	10
14 x 51	63	CHC63R	280	



Fuse Puller (for DIN type Fuse Link 6-630Amp)			[HSN Code: 8536]
Reference	MRP (₹)	MOQ	
CDFH003	420	1	

Porcelain Rewirable Fuse Holder (Kit-Kat)				[HSN Code: 8536]
Reference	Rating (Amps)	Fuse Wire Size (Max.)	MRP (₹)	MOQ
CSKTRW32	32	22SWG	370	3
CSKTRW63	63	18SWG	640	
CSKTRW100	100	14SWG	1130	
CSKTRW200	200	2 X 14SWG	2390	1



LIGHTING TRUNKING

LB Series



Features:

- LB Lighting trunking is used in all kinds of applications:
 - Lighting - Sensors
 - Dimmers - Emergency signalling / alarms
 - Power socket circuits
- Low weight & rigid housing
- High temperature resistance, flame retardant insulation
- Standard design of straight length with Plug in Point & accessories
- Common Plug in Box with detachable phase jaws & Universal bracket
- Quick & easy installation and mounting of luminaires

Lighting Trunking - LB Series

- Conforms -IEC 61439 (1&6)
- Operational voltage -500V
- Range -25A, 40A
- Plugin unit -6A~16A
- Busbar Configuration - 2P, 4P, 4P+2P, 4P+4P
- Busbar Material - Copper

Type	Description	Reference	UOM	MRP (₹)
Straight length	Straight length 1 meter with 1 PIP 2 Pole, 25A.	LBC252BG5S1P1	NOS	1850
	Straight length 1 meter with 1 PIP 4 Pole, 25A.	LBC254BG5S1P1	NOS	2440
	Straight length 1 meter with 1+1 PIP 4+2 Pole, 25A.	LBC256BG5S2P1	NOS	4280
	Straight length 1 meter with 1+1 PIP 4+4 Pole, 25A.	LBC258BG5S2P1	NOS	4870
	Straight length 1 meter with 1 PIP 2 Pole, 40A.	LBC402BG5S1P1	NOS	2210
	Straight length 1 meter with 1 PIP 4 Pole, 40A.	LBC404BG5S1P1	NOS	3200
	Straight length 1 meter with 1+1 PIP 4+2 Pole, 40A.	LBC406BG5S2P1	NOS	5410
	Straight length 1 meter with 1+1 PIP 4+4 Pole, 40A.	LBC408BG5S2P1	NOS	6410
	Straight length 3 meter with 3 PIP 2 Pole, 25A.	LBC252BG5S1P3	NOS	4830
	Straight length 3 meter with 3 PIP 4 Pole, 25A.	LBC254BG5S1P3	NOS	6540
	Straight length 3 meter with 3+3 PIP 4+2 Pole, 25A.	LBC256BG5S2P3	NOS	11370
	Straight length 3 meter with 3+3 PIP 4+4 Pole, 25A.	LBC258BG5S2P3	NOS	13080
	Straight length 3 meter with 3 PIP 2 Pole, 40A.	LBC402BG5S1P3	NOS	6090
	Straight length 3 meter with 3 PIP 4 Pole, 40A.	LBC404BG5S1P3	NOS	8800
	Straight length 3 meter with 3+3 PIP 4+2 Pole, 40A.	LBC406BG5S2P3	NOS	14890
Straight length 3 meter with 3+3 PIP 4+4 Pole, 40A.	LBC408BG5S2P3	NOS	17590	
Flexible Elbow	Flexible Elbow 1 meter, 2/4 Pole, 25/40A	LBC404BG5FXE1	NOS	9700
	Flexible Elbow 1 meter, 4+2/4+4 Pole, 25/40A	LBC408BG5FXE1	NOS	13310
	Flexible Elbow 3 meter, 2/4 Pole, 25/40A	LBC404BG5FXE3	NOS	14660
	Flexible Elbow 3 meter, 4+2/4+4 Pole, 25/40A	LBC408BG5FXE3	NOS	23230
End Feed Unit	End Feed Unit LHS (Direct), 2/4 Pole, 25/40A.	LBC404BG5EFDL	NOS	4420
	End Feed Unit LHS (Direct), 4+2/4+4 Pole, 25/40A.	LBC408BG5EFDL	NOS	5770
	End Feed Unit LHS (with MCB Provision), 2/4 Pole, 25/40A.	LBC404BG5EFSL	NOS	5870
	End Feed Unit LHS (with MCB Provision), 4+2/4+4 Pole, 25/40A.	LBC408BG5EFSL	NOS	7220
Center Feed unit	Center Feed Unit (Direct), 2/4 Pole, 25/40A.	LBC404BG5CFDS	NOS	10830
	Center Feed Unit (Direct), 4+2/4+4 Pole, 25/40A.	LBC408BG5CFDS	NOS	14430
	Center Feed Unit (with MCB Provision), 2/4 Pole, 25/40A.	LBC404BG5CFSS	NOS	11280
	Center Feed Unit (with MCB Provision), 4+2/4+4 Pole, 25/40A.	LBC408BG5CFSS	NOS	14890
End Cover	End Cover 2/4 Pole, RHS.	LBEC1R	NOS	250
	End Cover 2/4 Pole, LHS.	LBEC1L	NOS	270
	End Cover 4+2/4+4 Pole, RHS.	LBEC2R	NOS	290
	End Cover 4+2/4+4 Pole, LHS.	LBEC2L	NOS	320
Universal Bracket	Universal Bracket 2/4 Pole.	LBHB1U	NOS	360
	Universal Bracket 4+2/4+4 Pole .	LBHB2U	NOS	410
Plug in Box	Plug in Box (Direct), 2 Pole, 16A	LB12BP5D16	NOS	720
	Plug in Box (Direct), 4 Pole, 16A	LB14BP5D16	NOS	860
	Plug in Box (with fuse), 2 Pole, 6A	LB12BP5F06	NOS	900
	Plug in Box (with fuse), 4 Pole, 6A	LB14BP5F06	NOS	1220
	Plug in Box (with fuse), 2 Pole, 16A	LB12BP5F16	NOS	900
	Plug in Box (with fuse), 4 Pole, 16A	LB14BP5F16	NOS	1220

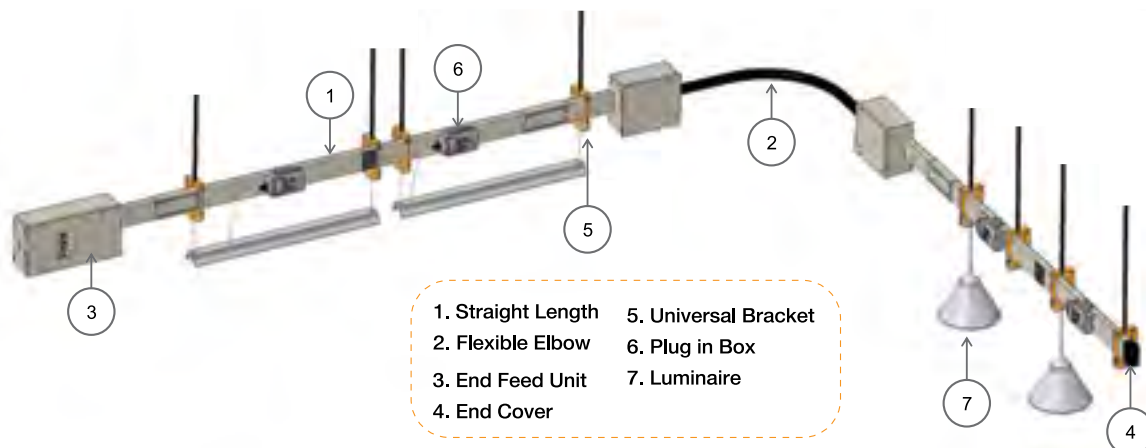

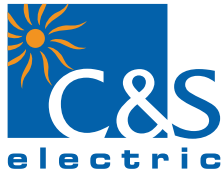

Power Control Components



MPCBs ■ Power Contactors ■ Mini Contactors
Overload Relays ■ Industrial Plugs & Sockets
Control & Signalling Devices ■ Motor Starters



Motor Protection Circuit Breaker

- Conforms to IEC 60947-2, IEC 60947-2
- Overload and Short circuit protection - Toggle and Rotary Type
- Short circuit protection - Rotary Type
- Breaking Capacity upto 100kA
- Finger Safe Terminals
- 35mm DIN rating mounting



exceed

Motor Protection Circuit Breaker

- Conforms to IEC 60947-2 , IEC 60947-2
- Overload and Short circuit protection - Toggle and Rotary Type
- Short circuit protection - Rotary Type
- Breaking Capacity upto 100kA
- Finger Safe Terminals
- 35mm DIN rating mounting



exceed Motor Protection Circuit Breaker - Toggle Type						[HSN Code: 8536]
Frame	Power Rating 3-Ph motors AC3-Duty 415V, 50/60HZ	Adjustable Range (Amp)	Breaking Capacity(kA) 415V, 50HZ	Reference	MRP (₹)	MOQ
	KW		With Overload & Short Circuit Protection			
32AF	-	0.1~0.16	100	TCMS-32SE-0.16	3600	1
	-	0.16~0.25	100	TCMS-32SE-0.25	3600	
	-	0.25~0.40	100	TCMS-32SE-0.4	3600	
	-	0.40~0.63	100	TCMS-32SE-0.63	3810	
	-	0.63~1	100	TCMS-32SE-1	3810	
	-	1~1.6	100	TCMS-32SE-1.6	3810	
	0.75	1.6~2.5	100	TCMS-32SE-2.5	3810	
	1.5	2.5~4	100	TCMS-32SE-4	4000	
	2.2	4~6.3	100	TCMS-32SE-6.3	4030	
	4	6~10	100	TCMS-32SE-10	4150	
	5.5	9~14	100	TCMS-32SE-14	4730	
	9	13~18	100	TCMS-32SE-18	5470	
	11	17~23	50	TCMS-32SE-23	5470	
	11	20~25	50	TCMS-32SE-25	5800	
15	24~32	50	TCMS-32SE-32	10690		

Accessories				[HSN Code: 8538]	
Description	Configuration	Model	MRP (₹)	MOQ	
Front mounted (1Pc) Aux Contact	1NO+1NC	TFXE11	760	1	
Front mounted (1Pc) Aux Contact	2NO	TFXE20	760		
Left Side Mounted (2Pc) Aux Contact	1NO+1NC	TLXE11	920		
Left Side Mounted (2Pc) Aux Contact	2NO	TLXE20	920		
Side mounted (1pc) Fault signal Contact	NO	TLAE11	1450		
Side mounted (1pc) Short circuit signal contact	NO	TLAME11	1500		
Trip + Aux Contact, Left Side mounted (1Pc.)	2NO	TLAXE1010	1000		
	1NO+1NC	TLAXE1001			
	1NC + 1NO	TLAXE0110			
	2NC	TLAXE0101			
Under Voltage (1 pc) Right side Mounted	110-127V50HZ	TRUE110-127V50HZ	1950		
	220-240V50HZ	TRUE220-240V50HZ			
	380-415V50HZ	TRUE380-415V50HZ			
Shunt Trip (1pc) Right side Mounted	110-127V50HZ	TRSE110-127V50HZ	1950		
	220-240V50HZ	TRSE220-240V50HZ			
	380-415V50HZ	TRSE380-415V50HZ			



MPCB



exceed

Motor Protection Circuit Breaker



exceed Motor Protection Circuit Breaker - Rotary Type

[HSN Code: 8536]

Frame	Power Rating 3Ph Motors AC3-duty, 415V,50Hz	Rated Operational Current Ie(A)	Breaking Capacity (kA) 415V, 50Hz	Reference	MRP (₹)	Adjustable range(Amp)	Reference	MRP (₹)
				With Short Circuit Protection			With Overload & Short Circuit Protection	
32AF	0.02	0.16	100kA	TCMS-32HS-0.16	3800	0.1-0.16	TCMS-32HS-0.16	3880
	0.06	0.25		TCMS-32HS-0.25	3800	0.16-0.25	TCMS-32HS-0.25	3880
	0.09	0.4		TCMS-32HS-0.4	3800	0.25-0.4	TCMS-32HS-0.4	3880
	0.12	0.63		TCMS-32HS-0.63	3800	0.4-0.63	TCMS-32HS-0.63	3880
	0.25	1		TCMS-32HS-1	3800	0.63-1	TCMS-32HS-1	3880
	0.55	1.6		TCMS-32HS-1.6	4370	1-1.6	TCMS-32HS-1.6	4450
	0.75	2.5		TCMS-32HS-2.5	4370	1.6-2.5	TCMS-32HS-2.5	4450
	1.5	4		TCMS-32HS-4	4370	2.5-4	TCMS-32HS-4	4450
	2.2	6.3		TCMS-32HS-6.3A	4370	4-6.3	TCMS-32HS-6.3	4450
	4	10		TCMS-32HS-10A	4370	6.3-10	TCMS-32HS-10	4450
	9	16	50kA	TCMS-32HS-16A	4570	10-16	TCMS-32HS-16	5630
	9	20		TCMS-32HS-20A	4940	16-20	TCMS-32HS-20	5630
	12.5	25		TCMS-32HS-25A	4940	20-25	TCMS-32HS-25	5970
	15	32		TCMS-32HS-32A	6820	25-32	TCMS-32HS-32	10930
63AF	7.5	16	TCMS-63HS-16	9800	11-16	TCMS-63HS-16	10000	
	7.5	20	TCMS-63HS-20	9800	14-20	TCMS-63HS-20	10000	
	11	25	TCMS-63HS-25	9800	18-25	TCMS-63HS-25	10000	
	15	32	TCMS-63HS-32	16940	22-32	TCMS-63HS-32	17140	
	18	40	TCMS-63HS-40	16940	28-40	TCMS-63HS-40	17140	
	18	45	TCMS-63HS-45	16940	36-45	TCMS-63HS-45	17140	
	22	50	TCMS-63HS-50	17960	40-50	TCMS-63HS-50	18200	
	30	63	TCMS-63HS-63	17960	45-63	TCMS-63HS-63	18200	



exceed

Motor Protection Circuit Breaker

Accessories			[HSN Code: 8538]
Description	Configuration	Reference	MRP (₹)
Front Mounted Auxiliary contacts	1NO+1NC	TFXS11	780
Left Side Mounted Auxiliary contacts	2NC	TFXS02	1100
Left Side Mounted Auxiliary contacts	1NO+1NC	TLXS11	1100
Left Side Mounted Auxiliary contacts	2NO	TLXS02	1100
"Left Side Mtd Trip ind Aux con (1NC/1NO for OL and 1NO/1NC for SC) for 32AF"	1NO+1NC	TLAS3211	1920
"Left Side Mtd Trip ind Aux con (1NC/1NO for OL and 1NO/1NC for SC) for 63AF"	1NO+1NC	TLAS6311	2000
MPCB Enclosure Frame 32AF	For TCMS-32HIS/32HS	EPH32HSBG	2900
MPCB Enclosure Frame 63AF	For TCMS-63HIS/63HS	EPH63HSBG	3270
Extended RotaryHandle -32AF-IP65	For TCMS-32HIS/32HS	EXTH32HSGB	1390
Extended Rotary Handle -63AF-IP65	For TCMS-63HIS/63HS	EXTH63HSGB	1470
Shunt Release 32AF / 63AF (Right Side Mounting)	20 ~ 24V 50/60Hz	TRSS20-24V 50/60Hz	1920
	40 ~ 48V 50/60Hz	TRSS40-48V 50/60Hz	
	100 ~ 127V 50/60Hz	TRSS40-100V 127/60Hz	
	200 ~ 240V 50/60Hz	TRSS40-200V 240/60Hz	
	365 - 440V 50/60Hz	TRSS40-365V 440/60Hz	
Under Voltage Release 32AF/63AF (Right Side Mounting)	24V 50/60Hz	TRUS 50Hz 60Hz 24V	1920
	24V 50Hz / 28V 60Hz	TRUS 50Hz 24V 60Hz 28V	
	95V 50Hz / 110V 60Hz	TRUS 50Hz 95V 60Hz 110V	
	110V 50Hz / 120V 60Hz	TRUS 50Hz 110V 60Hz 120V	
	110-115V 50Hz / 127V 60Hz	TRUS 50Hz 110-115V 60Hz 127V	
	180V 50Hz / 208V 60Hz	TRUS 50Hz 180V 60Hz 208V	
	190V 50Hz / 220V 60 Hz	TRUS 50Hz 190V 60Hz 220V	
	208V 50 Hz / 240V 60 Hz	TRUS 50Hz 208V 60Hz 240V	
	230-240V 50Hz / 277V 60Hz	TRUS 50Hz 230-240V 60Hz 277V	
	325V 50Hz / 380V 60Hz	TRUS 50Hz 325V 60Hz 380V	
	380V 50Hz / 440V 60Hz	TRUS 50Hz 380V 60Hz 440V	
	400-415V 50Hz / 480V 60Hz	TRUS 50Hz 400-415V 60Hz 480V	
	500V 50Hz / 600V 60Hz	TRUS 50Hz 500V 60Hz 600V	



Motor Protection Circuit Breaker

Conforming IS/IEC 60947-1, IS/IEC 60947-2, IS/IEC 60947-4-1

TCMS-Model - Thermal Magnetic									
<input type="checkbox"/> Adjustable thermal release <input type="checkbox"/> Magnetic release 13Xle Max. <input type="checkbox"/> Trip class 10 <input type="checkbox"/> Ambient temperature compensation <input type="checkbox"/> Phase failure protection									[HSN Code: 8536]
Frame	Power Rating 3-PhMotors AC3-duty 415V, 50Hz	Adjustable range (Amp)	Breaking Capacity (kA) 415V, 50Hz	Reference	MRP (₹)	Breaking Capacity (kA) 415V, 50Hz	Reference	MRP (₹)	MOQ
	kW								
32AF	0.02	0.1~0.16	100	<input checked="" type="checkbox"/> TCMS-32S-0.16	POR	100	TCMS-32H-0.16	POR	1
	0.06	0.16~0.25	100	<input checked="" type="checkbox"/> TCMS-32S-0.25		100	<input checked="" type="checkbox"/> TCMS-32H-0.25		
	0.09	0.25~0.4	100	TCMS-32S-0.4		100	<input checked="" type="checkbox"/> TCMS-32H-0.4		
	0.12	0.4~0.63	100	TCMS-32S-0.63		100	<input checked="" type="checkbox"/> TCMS-32H-0.63		
	0.25	0.63~1	100	TCMS-32S-1		100	TCMS-32H-1		
	0.55	1~1.6	100	TCMS-32S-1.6		100	TCMS-32H-1.6		
	0.75	1.6~2.5	100	TCMS-32S-2.5		100	TCMS-32H-2.5		
	1.5	2.5~4	100	TCMS-32S-4		100	TCMS-32H-4		
	2.2	4~6	100	TCMS-32S-6		100	TCMS-32H-6		
	3	5~8	100	TCMS-32S-8		100	TCMS-32H-8		
	4	6~10	50	TCMS-32S-10		100	TCMS-32H-10		
	5.5	9~13	50	TCMS-32S-13		100	TCMS-32H-13		
	7.5	11~17	20	TCMS-32S-17		50	TCMS-32H-17		
	7.5	14~22	15	TCMS-32S-22		50	TCMS-32H-22		
	11	18~26	15	TCMS-32S-26		50	TCMS-32H-26		
15	22~32	15	TCMS-32S-32	50	TCMS-32H-32				
63AF	18.5	28~40	-	-	50	TCMS-63H-40	18690		
	22	34~50	-	-	50	TCMS-63H-50	21670		
	30	45~63	-	-	50	TCMS-63H-63	23120		
100AF	37	55~75	-	-	75	<input checked="" type="checkbox"/> TCMS-100H-75	23270		
	45	70~90	-	-	75	<input checked="" type="checkbox"/> TCMS-100H-90	23300		
	45	80~100	-	-	75	<input checked="" type="checkbox"/> TCMS-100H-100	23500		

TCMS-Model - Magnetic (Short Circuit Protection only)						
<input type="checkbox"/> Without thermal release <input type="checkbox"/> Magnetic release 13 X le Max.						[HSN Code: 8536]
Frame	Breaking Capacity (kA) at 415V, 50Hz	Power Rating 3-Ph Motors AC3 duty 415V, 50Hz	Rated Operational Current Ie (A)	Reference	MRP (₹)	MOQ
		kW				
32AF	100	0.02	0.16	TCMS-32HI-0.16	POR	1
	100	0.06	0.25	TCMS-32HI-0.25		
	100	0.09	0.4	<input checked="" type="checkbox"/> TCMS-32HI-0.4		
	100	0.12	0.63	<input checked="" type="checkbox"/> TCMS-32HI-0.63		
	100	0.25	1	TCMS-32HI-1		
	100	0.55	1.6	<input checked="" type="checkbox"/> TCMS-32HI-1.6		
	100	0.75	2.5	<input checked="" type="checkbox"/> TCMS-32HI-2.5		
	100	1.5	4	<input checked="" type="checkbox"/> TCMS-32HI-4		
	100	2.2	6	<input checked="" type="checkbox"/> TCMS-32HI-6		
	100	3	8	<input checked="" type="checkbox"/> TCMS-32HI-8		
	100	4	10	<input checked="" type="checkbox"/> TCMS-32HI-10		
	100	5.5	13	<input checked="" type="checkbox"/> TCMS-32HI-13		
	50	7.5	17	<input checked="" type="checkbox"/> TCMS-32HI-17		
	50	7.5	22	<input checked="" type="checkbox"/> TCMS-32HI-22		
	50	11	26	<input checked="" type="checkbox"/> TCMS-32HI-26		
50	15	32	<input checked="" type="checkbox"/> TCMS-32HI-32			
63AF	50	18.5	40	<input checked="" type="checkbox"/> TCMS-63HI-40	15040	
	50	22	50	<input checked="" type="checkbox"/> TCMS-63HI-50	17420	
	50	30	63	<input checked="" type="checkbox"/> TCMS-63HI-63	17560	
100AF	75	37	75	TCMS-100HI-75	18680	
	75	45	90	<input checked="" type="checkbox"/> TCMS-100HI-90	19240	
	75	45	100	TCMS-100HI-100	19240	

Non Stockable item



Motor Protection Circuit Breaker

Conforming IS/IEC 60947-1, IS/IEC 60947-2, IS/IEC 60947-4-1



Accessories			[HSN Code: 8538]	
Description	Configuration	Model	MRP (₹)	MOQ
Auxiliary switch for front mounting	1NO+1NC	TFX11 (32A)	890	1
	1NO+1NC	TFX11		
	2NC	TFX02		
	2NO	TFX20		
Auxiliary switch for front side mounting on the left	1NO+1NC	TLX11	1070	
	2NC	<input checked="" type="checkbox"/> TLX02		
	2NO	<input checked="" type="checkbox"/> TLX20		
Any trip alarm switch for side mounting on the left (TCMS-32)	1NO+1NC	TLA11	1360	
	2NC	TLA02		
Any trip alarm switch for side mounting on the left (TCMS-63-100)	1NO+1NC	TLA11(63-100)	1360	
	2NC	TLA02(63-100)		
Magnetic trip alarm switch for side mounting on the left	1NO+1NC	<input checked="" type="checkbox"/> TLAM11	1410	
Shunt release for side mounting on the right	110~127V50Hz	<input checked="" type="checkbox"/> TRS110~127V50Hz	2270	
	220~230V50Hz	<input checked="" type="checkbox"/> TRS220~230V50Hz		
	415~440V50Hz	TRS415~440V50Hz		
Undervoltage release for side mounting on the right	110~127V50Hz	TRU110~127V50Hz	2320	
	220~230V50Hz	<input checked="" type="checkbox"/> TRU220~230V50Hz		
	415~440V50Hz	TRU415~440V50Hz		
Undervoltage release with switch for side mounting on the right	110~127V50Hz	TRUX110~127V50Hz	2320	
	220~230V50Hz	<input checked="" type="checkbox"/> TRUX220~230V50Hz		
	415~440V50Hz	TRUX415~440V50Hz		
Insulation Barrier (for TCMS-100H/100HI only)		<input checked="" type="checkbox"/> TIB100	700	
Adaptor kit for MPCB + Mini Contactors	TCMS-32S+TC1M06-16	TDA-16SA	700	
	TCMS-32S+TP1M06-16	TDA-16SD		
	TCMS-32H/32HI+TC1M06-16	TDA-16HA		
	TCMS-32H/32HI+TP1M06-16	<input checked="" type="checkbox"/> TDA-16HD		
Busbar	2 Point	PB322	1170	
		PB632		
Busbar	3 Point*	<input checked="" type="checkbox"/> PB323	1350	
		PB633		
MPCB Enclosure (IP 65 Category)	For TCMS-32H/HI	EPH32-65S	1930	
Extended Handle (Door Mounting with Door Interlock, Defeat Interlock & Padlock)	Extension Shaft 115mm		1650	1
	TCMS-32H/HI	MEH32-115		
	TCMS-63H/HI	<input checked="" type="checkbox"/> MEH63-115		
	TCMS-100H/HI	<input checked="" type="checkbox"/> MEH100-115		
	Extension Shaft 315mm		1790	1
	TCMS-32H/HI	MEH32-315		
	TCMS-63H/HI	<input checked="" type="checkbox"/> MEH63-315		
	TCMS-100H/HI	<input checked="" type="checkbox"/> MEH100-315		

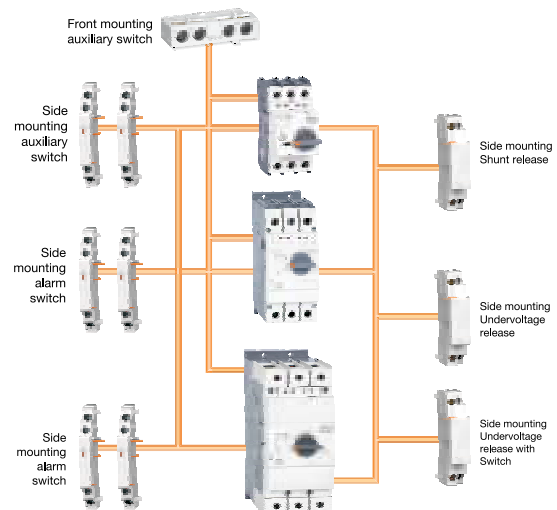

Non Stockable item



robusta2
Contactor 7A~38A

robusta
Contactor 9A~800A



TC Contactors. Enjoy life, non-stop.





robusta2 Contactor

Conforming IEC60947-1, IEC60947-4-1 & IEC60947-5-1



Contactor				[HSN Code: 8536]			
AC1 Duty (A)	AC3 415V Long life			Auxiliary Contacts	Reference	MRP (₹)	MOQ
	kW	HP	A				
25	2.2	3	7	1 NO+1NC	TC1D0711	1640	1
25	4	5.5	9	1 NO+1NC	TC1D0911	1800	
25	5.5	7.5	12	1 NO+1NC	TC1D1211	1920	
32	9	12	18	1 NO+1NC	TC1D1811	2300	
40	11	15	25	1 NO+1NC	TC1D2511	2920	
50	15	20	32	1 NO+1NC	TC1D3211	6200	
50	18.5	25	38	1 NO+1NC	TC1D3811	8590	

Spare Top Housing for 3P Contactors				[HSN Code: 8538]			
For Contactor	Reference	MRP (₹)	MOQ				
TC1-D0711	TA5-D0711	1240	1				
TC1-D0911	TA5-D0911						
TC1-D1211	TA5-D1211						
TC1-D1811	TA5-D1811	1430					
TC1-D2511	TA5-D2511	1840					
TC1-D3211	TA5-D3211	3510					
TC1-D3811	TA5-D3811	5180					

Coil Surge Suppressor					[HSN Code: 8538]				
Description	Voltage Ratings	Reference	MRP (₹)	MOQ					
Varistor (AC/DC) Clip on mounting	12-55V 50/60Hz	TAD4VE	770	10					
	56-136V 50/60Hz	TAD4VF							
	137-277V 50/60Hz	TAD4VU							
	278-575V 50/60Hz	TAD4VN							

Spare AC Coils for Contactor				[HSN Code: 8538]			
Use for Contactor	Reference	MRP (₹)	MOQ				
TC1D07	TX1-D3	780	1				
TC1D09							
TC1D12							
TC1D18							
TC1D25							
TC1D32							
TC1D38							

Mechanical Interlocks-Horizontal Mounted				[HSN Code: 8538]			
Use of Contactor	Reference	MRP (₹)	MOQ				
TC1D07-TC1D38	LA9-D09978	690	10				

robusta2 Contactor Coils							[HSN Code: 8538]						
Contactor TC1-D/TX1D3		24V	48V	110V	220V	240V	415V						
50 Hz		B5	E5	F5	M5	U5	N5						

Thermal Overload Relay						[HSN Code: 8536]	
Relay setting range (A)	Standard power ratings of 3-Phase Motors 50/60Hz, AC3 Category		Reference	Suitable for Contactor Rating (Amps)	MRP (₹)	Independent Mounting Kit	
	HP	kW					
23-32	20	15	TR2DM32353	32	3370	TA7D3264 MRP ₹460	
30-38	30	22	TR2DM38355	38			

NOTE: robusta 2 Thermal Overload Relay reference TR2DM32353 ~TR2DM38355 can be mounted directly on robusta 2 Contactor without any additional fixing attachment.

How to order:

- i) Select applicable Coil Voltage required for Contactor.
- ii) Complete the code by replacing the form above.
- iii) For common accessories please refer Page No. 81 & 82.
- iv) MOQ- Minimum Order Quantity

* Stock for accessories are subject to availability. X Non Stockable item

Power Contactor DX-Series

Conforming IEC60947-1, IEC60947-4-1

Features:

- Suitable for Bus-Bar termination
- Single termination upto Power Contact
- Easy Coil Replacement
- Same Auxiliary blocks as Robusta
- Suitable for ring type busbar connection

Application:

- DG Panels
- Motor Feeder & Control System
- Street lighting
- VFD, Soft Starters applications
- UPS, Battery Charging
- Solar and Wind inverters



3 Pole Power Contactor						[HSN Code: 8536]
AC1 Duty A	AC3 415 V Long Life			With AC Coil		MOQ
	kW	HP	A	Reference	MRP (₹)	
85	25	34	45	TC1DX453 ■	7740	1
	26	35	50	TC1DX503 ■	9720	
100	37	50	70	TC1DX703 ■	13670	
	40	54	80	TC1DX803 ■	16660	



Add-On Block for Contactor Rating 45A-80A				[HSN Code: 8536]	
Contact Configuration		Reference	MRP (₹)	MOQ	
Front Mounted	2 NO	TA1-DN20	530	20	
	1 NO+1 NC	TA1-DN11			
	2 NC	TA1-DN02			
	Front Mounted	4 NO	TA1-DN40	780	20
		3 NO+1 NC	TA1-DN31		
		2 NO+2 NC	TA1-DN22		
		1 NO+3 NC	TA1-DN13		
Side Mounted	4 NC	TA1-DN04	780	10	
	1 NO+1 NC	TA8-DN11			
	2 NO	TA8-DN20			



Spare Coil				[HSN Code: 8536]
Reference	Coil Voltage	MRP (₹)	MOQ	
LX1DX45 ■	110 / 220 / 240 / 415	2440	1	

Spare Contact Kit				[HSN Code: 8536]
Reference	Description	MRP (₹)	MOQ	
TA5X453	45A Contact Kit, 3 Pole	4580	1	
TA5X503	50A Contact Kit, 3 Pole	5480		
TA5X703	70A Contact Kit, 3 Pole	7800		
TA5X803	80A Contact Kit, 3 Pole	10300		

Mechanical Interlock Kit				[HSN Code: 8536]
Reference	Description	MRP (₹)	MOQ	
LA9DX8002	Mechanical Interlock Kit for Contactor TC1DX45A-80A	3130	1	

Coil Surge Suppressor for Contactor 45A-80A					[HSN Code: 8536]
Description	Voltage Ratings	Reference	MRP (₹)	MOQ	
RC Circuit (AC)	110-240V AC	LA9DX980U	710	1	

AC Coil Voltage Codes for Contactors 45A-80A					[HSN Code: 8536]
Contactor	Voltage				
	110	220	240	415	
TC1DX45-80 50Hz	F	M	U	N	

■ To specify Coil Voltage.

NOTE: Stock for accessories are subject to availability
MOQ - Minimum Order Quantity



Mini Contactors

Conforming IEC60947-1, IEC60947-4-1 & IEC60947-5-1



Control Relays - 10 Amps								[HSN Code: 8536]
Rated Current (Ith)	Contact Configuration	With AC Coil			With DC Coil			
		Reference	MRP (₹)	MOQ	Reference	MRP (₹)	MOQ	
10	2NO+2NC	☒TCA2-M22	1820	10	☒TCA3-M22	2430	10	
	3NO+1NC	☒TCA2-M31			☒TCA3-M31			
	4NO	☒TCA2-M40			☒TCA3-M40			
	1NO + 3NC	☒TCA2-M13			☒TCA3-M13			
	4NC	☒TCA2-M04			☒TCA3-M04			

■ Please specify Coil Voltage.

Power Contactors - 3 Pole												[HSN Code: 8536]
AC1 Duty A	AC3 415V Long Life			Auxiliary Contacts	With AC Coil			Auxiliary Contacts	With DC Coil			
	kW	HP	A		Reference	MRP (₹)	MOQ		Reference	MRP (₹)	MOQ	
20	2.2	3	6	1NO -	☒TC1-M0610	1570	10	1NO -	☒TP1-M0610	2290	10	
				- 1NC	☒TC1-M0601			- 1NC	☒TP1-M0601			
	4	5.5	9	1NO -	☒TC1-M0910	1700		1NO -	☒TP1-M0910	2390		
				- 1NC	☒TC1-M0901			- 1NC	☒TP1-M0901			
	5.5	7.5	12	1NO -	☒TC1-M1210	1810		1NO -	☒TP1-M1210	2620		
				- 1NC	☒TC1-M1201			- 1NC	☒TP1-M1201			
	7.5	10	16	1NO -	☒TC1-M1610	2140		1NO -	☒TP1-M1610	2890		
				- 1NC	☒TC1-M1601			- 1NC	☒TP1-M1601			

■ Please specify Coil Voltage.

Coil Voltage Codes for Mini Contactors & Control Relays						
Contactor	Voltage					
	24	48	110	220	415	
AC	B	E	F	M	N	
DC	BD	ED	FD	MD	-	

Overload Relays for Mini Contactors - Direct Mounting						[HSN Code: 8536]
Relay Range (Amps)	Reference	MRP (₹)	MOQ	Independent Mounting Kit		
0.10 - 0.16	TR2 - M0.14A	2120	1	Reference TA7-M0964 MRP (₹) 640 [HSN Code: 8538]		
0.16 - 0.25	☒TR2 - M0.21A					
0.25 - 0.4	TR2 - M0.33A					
0.4 - 0.63	TR2 - M0.52A					
0.63 - 1	TR2 - M0.82A					
1 - 1.6	TR2 - M1.3A					
1.6 - 2.5	TR2 - M2.1A					
2.5 - 4	TR2 - M3.3A					
4 - 6	TR2 - M5A					
5 - 8	☒TR2 - M6.5A					
6 - 9	☒TR2 - M7.5A					
7 - 10	TR2 - M8.5A					
9 - 13	TR2 - M11A	2300				
12 - 16	☒TR2 - M14A					

☒ Non Stockable item. MOQ- Minimum Order Quantity

Accessories

Add-On-Block [HSN Code: 8538]				
Contact Configuration		Reference	MRP (₹)	MOQ
Front Mounted	2NO	TA1-M20	480	10
	1NO+1NC	TA1-M11		
	2NC	TA1-M02		
	4NO	TA1-M40	770	
	3NO+1NC	☒TA1-M31		
	2NO+2NC	TA1-M22		
	1NO+3NC	☒TA1-M13		
	4NC	TA1-M04		
Side Mounted	1NC	TA8-M01	470	
	1NO	TA8-M10		

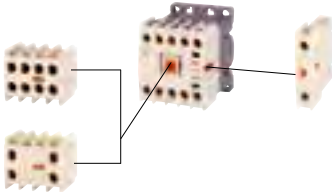

Mechanical Interlocks for Horizontally Mounted [HSN Code: 8538]				
Use For Contactor		Reference	MRP (₹)	MOQ
AC	DC			
TC1-MS06	TP1-MS06	☒TA9-M978	720	1
TC1-MS09	TP1-MS09			
TC1-MS12	TP1-MS12			
TC1-MS16	TP1-MS16			



Electronic Timer [HSN Code: 8538]					
Description	Delay	Time	Voltage	Reference	MRP (₹)
Front Mounting Electronic Timer	ON Delay	0.1-30Sec	AC / DC24-48V	☒TA2-M/ 1N	2320
	ON Delay	0.1-30Sec	AC110-220V	☒TA2-M/ 2N	
	OFF Delay	0.1-30Sec	AC / DC24-48V	TA3-M/ 1F	
	OFF Delay	0.1-30Sec	AC110-220V	TA3-M/ 2F	



Coil Suppressor [HSN Code: 8538]				
Description	Voltage	Reference	MRP (₹)	MOQ
Varistor	AC 24-48V	TA9-M980/1	760	10
	AC 60-127V	TA9-M980/2		
	AC 200-240V	☒TA9-M980/3		
	DC 12-24V	TA9-M980/4		
	DC 30-72V	TA9-M980/5		
	DC 100-127 V	TA9-M980/6		
	DC 200-250 V	TA9-M980/7		

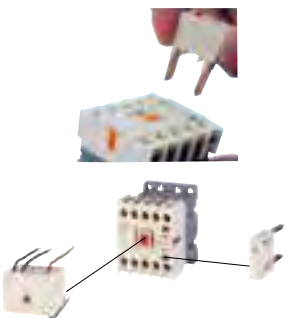

* Stock for accessories are subject to availability. ☒ Non Stockable item



Exceed Contactor

Conforming IEC60947-1, IEC60947-4-1 & IEC60947-5-1



Exceed 3 Pole Power Contactor rating 6A-95A										[HSN Code: 8536]	
Size	AC1 Duty A	AC3 415V Long Life			Auxiliary Contacts	With AC Coil		Auxiliary Contacts	With DC Coil		MOQ
		KW	HP	A		Reference	MRP (₹)		Reference	MRP (₹)	
Frame-1	25	2.2	3	6	1NO	TC1D0610E	1220	-	-	-	1
					1NC	TC1D0601E	1220	-	-	-	
		4	5.5	9	1NO	TC1D0910E	1390	1NO	TP1D0910E	2120	
					1NC	TC1D0901E	1390	1NC	TP1D0901E	2120	
		5.5	7.5	12	1NO	TC1D1210E	1510	1NO	TP1D1210E	2310	
					1NC	TC1D1201E	1510	1NC	TP1D1201E	2310	
32	9	12.5	18	1NO	TC1D1810E	1760	1NO	TP1D1810E	2600		
				1NC	TC1D1801E	1760	1NC	TP1D1801E	2600		
Frame-2	40	11	15	25	1NO	TC1D2510E	2430	1NO	TP1D2510E	3780	
					1NC	TC1D2501E	2430	1NC	TP1D2501E	3780	
	50	15	20	32	1NO	TC1D3210E	5170	1NO	TP1D3210E	7700	
					1NC	TC1D3201E	5170	1NC	TP1D3201E	7700	
Frame-3	60	22	30	40	1NO+1NC	TC1D4011E	7290	1NO+1NC	TP1D4011E	11340	
					1NO+1NC	TC1D5011E	8780	1NO+1NC	TP1D5011E	11910	
	80	37	50	65	1NO+1NC	TC1D6511E	12510	1NO+1NC	TP1D6511E	16960	
					1NO+1NC	TC1D8011E	15920	1NO+1NC	TP1D8011E	21580	
	125	45	60	95	1NO+1NC	TC1D9511E	18980	1NO+1NC	TP1D9511E	25750	

Exceed 4 Pole Power Contactor rating 12A-95A					[HSN Code: 8536]
AC1 Duty A	Main Pole Configuration		Reference	MRP (₹)	MOQ
25	4NO	--	TC1D12004E	1700	5
	2NO	2NC	TC1D12008E	2150	
32	4NO	--	TC1D18004E	1970	
40	4NO	--	TC1D25004E	2880	
	2NO	2NC	TC1D25008E	4240	
60	4NO	--	TC1D40004E	7750	
	2NO	2NC	TC1D40008E	12220	
80	4NO	--	TC1D50004E	9790	
	2NO	2NC	TC1D50008E	13190	
	4NO	--	TC1D65004E	12590	
	2NO	2NC	TC1D65008E	14500	
125	4NO	--	TC1D80004E	16130	
	2NO	2NC	TC1D80008E	19780	
	4NO	--	TC1D95004E	20100	
	2NO	2NC	TC1D95008E	21590	

Wide band Coil available in 50 Hz only
 Note: Stock for accessories are subject to availability
 ■ Non-Standard coil Extra MRP @ ₹ 180 per contactor
 * Available from CR-38A Contactor only.

AC Coil Voltage Codes for Contactors 9A-95A & Control Relays							
Contactor	Voltage						
TC1-D	24	48	110	220	235	240	415
50Hz	B5	E5	F5	M5	C5W*	U5	N5
50/60Hz	B7	E7	F7	M7	-	U7	N7

DC Coil Voltage Codes for Contactors 9A-95A & Control Relays					
Contactor	Voltage				
TP1-D	24	48	72	110	220
Normal Coil	BD	ED	SD	FD	MD
Wide band Coil#	BW	EW	-	FW	-

- NOTE:**
1. Add Suffix ■ Coil voltage to complete product code
 2. 235 V (C5W) Coil available only upto 38 Amps (AC3) Contactors.
 3. 22A, 38A & 45A current ratings also available on request. (MOQ - 50 Nos.)
 4. For add-on accessories and spare coil refer Page No. 81 & 82.



Exceed Contactor

Conforming IEC60947-1, IEC60947-4-1 & IEC60947-5-1



Exceed Contactor 3 Pole: Rating 115 A- 630A								[HSN Code: 8536]
AC1 Duty A	AC3 415 V Long Life			With AC Coil		With DC Coil		MOQ
	kW	HP	A	Reference	MRP (₹)	Reference	MRP (₹)	
200	59	80	115	LC1FDP115AE	23230	LC1FDP115AE	27880	5
250	80	108	150	LC1FDP150AE	32980	LC1FDP150AE	39580	
275	100	136	185	LC1FDP185AE	38250	LC1FDP185AE	45900	
315	110	148	225	LC1FDP225AE	43240	LC1FDP225AE	51890	
350	140	190	265	LC1FDP265AE	51470	LC1FDP265AE	61760	
400	180	240	330	LC1FDP330AE	62620	LC1FDP330AE	75140	
500	220	300	400	LC1FDP400AE	73780	LC1FDP400AE	88540	
700	280	380	500	LC1FDP500AE	104430	LC1FDP500AE	125320	
1000	375	500	630	LC1FDP630AE	152750	LC1FDP630AE	183300	

Exceed Contactors 4 Pole: Rating AC1 200A ~ 1000A						[HSN Code: 8536]
AC1 Duty A	Main Pole Configuration	With AC Coil		With DC Coil		MOQ
		Reference	MRP (₹)	Reference	MRP (₹)	
200	4 NO	LC1FDP1154AE	28590	LC1FDP1154AE	POR	5
250	4 NO	LC1FDP1504AE	36650	LC1FDP1504AE		
275	4 NO	LC1FDP1854AE	54100	LC1FDP1854AE		
315	4 NO	LC1FDP2254AE	54780	LC1FDP2254AE		
350	4 NO	LC1FDP2654AE	59640	LC1FDP2654AE		
400	4 NO	LC1FDP3304AE	70680	LC1FDP3304AE		
500	4 NO	LC1FDP4004AE	91140	LC1FDP4004AE		
700	4 NO	LC1FDP5004AE	109370	LC1FDP5004AE		
1000	4 NO	LC1FDP6304AE	216290	LC1FDP6304AE		

AC Coil Voltage Codes for Contactors 115A-780A				
Contactor	Voltage			
	110	220	240	415
LC1FDP115-225 50Hz	F5	M5	U5	N5
LC1FDP265-780 50/60Hz	F7	M7	U7	N7

DC Coil Voltage Codes for Contactors 115A-780A				
Contactor	Voltage			
	24#	48	110	220
LC1FDP	BD	ED	FD	MD

Not available for LC1FDP630



robustA Power Contactors

Conforming IEC60947-1, IEC60947-4-1 & IEC60947-5-1



Control Relays - 10 Amps										[HSN Code: 8536]		
Rated Current(Ie) AC15 at 240V (Amps)	Contact Configuration	With AC Coil			With DC Coil							
		Reference	MRP (₹)	MOQ	Reference	MRP (₹)	MOQ					
10	2NO + 2NC	TCA2-DN22	1680	10	TCA3-DN22	2610	10					
	3NO + 1NC	TCA2-DN31			TCA3-DN31							
	4NO	TCA2-DN40			TCA3-DN40							

Power Contactors 3 Pole : Rating 9A - 95A										[HSN Code: 8536]				
Size	AC1 Duty A	AC3 415 V Long Life			Auxiliary Contacts		With AC Coil		MOQ	Auxiliary Contacts		With DC Coil		MOQ
		kW	HP	A			Reference	MRP (₹)				Reference	MRP (₹)	
Frame 1	25	4	5.5	9	1NO	-	TC1-D0910	1560	1	1NO	-	TP1-D0910	2450	1
					-	1NC	TC1-D0901	1560		-	1NC	TP1-D0901	2450	
		5.5	7.5	12	1NO	-	TC1-D1210	1760		1NO	-	TP1-D1210	2720	
					-	1NC	TC1-D1201	1760		-	1NC	TP1-D1201	2720	
	32	9	12.5	18	1NO	-	TC1-D1810	2140		1NO	-	TP1-D1810	3100	
					-	1NC	TC1-D1801	2140		-	1NC	TP1-D1801	3100	
		11	15	22	1NO	-	TC1-D2210	2490		1NO	-	TP1-D2210	4390	
					-	1NC	TC1-D2201	2490		-	1NC	TP1-D2201	4390	
Frame 2	40	11	15	25	1NO	-	TC1-D2510	2730	1NO	-	TP1-D2510	4560		
					-	1NC	TC1-D2501	2730	-	1NC	TP1-D2501	4560		
	50	15	20	32	1NO	-	TC1-D3210	5620	1NO	-	TP1-D3210	8830		
					-	1NC	TC1-D3201	5620	-	1NC	TP1-D3201	8830		
		18.5	25	38	1NO	-	TC1-D3810	7860	1NO	-	TP1-D3810	10220		
					-	1NC	TC1-D3801	7860	-	1NC	TP1-D3801	10220		
	Frame 3	60	22	30	40	1NO	1NC	TC1-D4011	8370	1NO	1NC	TP1-D4011	12330	
						1NO	1NC	TC1-D4511	9920	1NO	1NC	TP1-D4511	14690	
80		22	30	45	1NO	1NC	TC1-D5011	10430	1NO	1NC	TP1-D5011	15580		
					1NO	1NC	TC1-D6511	13880	1NO	1NC	TP1-D6511	16680		
100		37	50	70	1NO	1NC	TC1-D7011	14340	1NO	1NC	TP1-D7011	19400		
					1NO	1NC	TC1-D8011	17490	1NO	1NC	TP1-D8011	20850		
125		45	60	80	1NO	1NC	TC1-D8011	17490	1NO	1NC	TP1-D8011	20850		
					1NO	1NC	TC1-D9511	21190	1NO	1NC	TP1-D9511	26660		

AC Coil Voltage Codes for Contactors 9A-95A & Control Relays							
Contactor	Voltage						
TCA2-DN/TC1-D	24	48	110	220	235	240	415
50Hz	B5	E5	F5	M5	C5W*	U5	N5
50/60Hz	B7	E7	F7	M7	-	U7	N7

DC Coil Voltage Codes for Contactors 9A-95A & Control Relays					
Contactor	Voltage				
TCA3-DN/TP1-D	24	48	72	110	220
Normal Coil	BD	ED	SD	FD	MD
Wide band Coil#	BW	EW	-	FW	-

Wide band Coil available in 50 Hz only

Note: Stock for accessories are subject to availability

■ Non-Standard coil Extra MRP @ ₹ 180 per contactor

* Available from CR-38A Contactor only.



robusta Power Contactors

Conforming IEC60947-1 & IEC60947-4-1



Power Contactors 4 Pole : Rating AC1 25A ~ 125A						[HSN Code: 8536]			
AC1 Duty A	AC1 Duty A	Main Pole Configuration		With AC Coil		MOQ	With DC Coil		MOQ
				Reference	MRP (₹)		Reference	MRP (₹)	
Frame 1	25	4NO	--	TC1-D12004 ■	1960	1	TP1-D12004 ■	3840	1
		2NO	2NC	☒ TC1-D12008 ■	2400		☒ TP1-D12008 ■	4820	
32	4NO	--	☒ TC1-D18004 ■	2250	-		-		
	40	4NO	--	TC1-D25004 ■	3320		TP1-D25004 ■	7400	
2NO		2NC	☒ TC1-D25008 ■	4660	☒ TP1-D25008 ■		9260		
Frame 3	60	4NO	--	TC1-D40004 ■	8830		TP1-D40004 ■	13220	
		2NO	2NC	☒ TC1-D40008 ■	13060		☒ TP1-D40008 ■	19690	
	80	4NO	--	TC1-D50004 ■	11030		-	-	
		2NO	2NC	☒ TC1-D50008 ■	15130		-	-	
		4NO	--	☒ TC1-D65004 ■	14300		TP1-D65004 ■	21110	
		2NO	2NC	TC1-D65008 ■	16650		☒ TP1-D65008 ■	25580	
	100	4NO	--	☒ TC1-D70004 ■	14820		☒ TP1-D70004 ■	24310	
		125	4NO	--	TC1-D80004 ■	18500	TP1-D80004 ■	26510	
	2NO		2NC	☒ TC1-D80008 ■	22520	☒ TP1-D80008 ■	29650		
	4NO		--	TC1-D95004 ■	22370	TP1-D95004 ■	28250		
	2NO		2NC	☒ TC1-D95008 ■	24550	☒ TP1-D95008 ■	30650		

Power Contactors 4 Pole 4NC : Rating 9A ~ 25A						[HSN Code: 8536]		
Size	AC1 Duty A	AC3 415 V Long Life			With AC Coil		MRP (₹)	MOQ
		KW	HP	A	Reference			
Frame 1	25	4	5.5	9	TC1-D09006 ■	2110	10	
		5.5	7.5	12	TC1-D12006 ■	3910		
Frame 2	40	11	15	25	TC1-D25006 ■	4360		

AC Coil Voltage Codes for Contactors 9A-95A & Control Relays							
Contactor	Voltage						
TCA2-DN/TC1-D	24	48	110	220	235	240	415
50Hz	B5	E5	F5	M5	C5W*	U5	N5
50/60Hz	B7	E7	F7	M7	-	U7	N7

DC Coil Voltage Codes for Contactors 9A-95A & Control Relays					
Contactor	Voltage				
TCA3-DN/TP1-D	24	48	72	110	220
Normal Coil	BD	ED	SD	FD	MD
Wide band Coil#	BW	EW	-	FW	-

- NOTE:**
1. Add Suffix ■ Coil voltage to complete product code
 2. 235 V (C5W) Coil available only upto 38 Amps (AC3) Contactors.
 3. 22A, 38A & 45A current ratings also available on request. (MOQ - 50 Nos.)
 4. For add-on accessories and spare coil refer Page No. 81 & 82.

- # Wide band Coil available in 50 Hz only
 Note: Stock for accessories are subject to availability
- Non-Standard coil Extra MRP @ ₹ 180 per contactor
 - * Available from CR-38A Contactor only.



robust Power Contactors

Conforming IEC60947-1 & IEC60947-4-1



Power Contactors 3 Pole : 115~160A AC3							[HSN Code: 8536]	
AC1 Duty A	AC3 415 V Long Life			Auxiliary contacts		With AC Coil		MOQ
	kW	HP	A			Reference	MRP (₹)	
200A	55	73	115	1NO	1NC	TC1-D115116■*	24970	1
	55	73	115	1NO	1NC	TC1-D11511■*	25190	
	55	73	120	1NO	1NC	TC1-D120116■*	25710	
	55	73	120	1NO	1NC	TC1-D12011■*	26050	
	75	101	150	1NO	1NC	TC1-D150116■*	33570	
	75	101	150	1NO	1NC	TC1-D15011■*	34100	
	75	101	160	1NO	1NC	TC1-D160116■*	34810	
	75	101	160	1NO	1NC	TC1-D16011■*	35140	

Power Contactors 4 Pole: Rating AC1 200A					[HSN Code: 8536]	
AC1 Duty A	Main Pole Configuration		With AC Coil		MOQ	
			Reference	MRP (₹)		
200A	4NO	--	TC1-D115004■*	27290	1	
	4NO	--	TC1-D1150046■*	26930		
	4NO	--	TC1-D150004■*	35490		
	4NO	--	TC1-D1500046■*	35320		

* Busbar connection * Cable connection

Spare main contacts sets (115~160), 3P/4P				[HSN Code: 8538]	
Contactor	Reference	MRP (₹)	MOQ		
TC1D115	TA5 D115118031	9380	1		
TC1D120	TA5 D120118031	9720			
TC1D150	TA5 D150118031	11000			
TC1D160	TA5 D160118031	11820			
TC1D115004	TA5 D115804	11520			
TC1D150004	TA5 D150804	12170			
Spare Busbar connection sets (115~160), 3P/4P					
TC1D115	TA9 D11511503	500	1		
TC1D120					
TC1D150					
TC1D160					
TC1D115004	TA9 D115504	780			
TC1D150004					
Spare Arc Chamber (top housing) for 3P Contactors (115-160)					
TC1D115	TA5 D1151150	330	1		
TC1D120	TA5 D1201150				
TC1D150	TA5 D1501150				
TC1D160	TA5 D1601150				
Spare Coils (115~160), 3 Pole / 4 Pole					
AC Coil 50 Hz AC	TX1D8■B5	2630	1		
	TX1D8■F5				
	TX1D8■M5				
	TX1D8■N5				

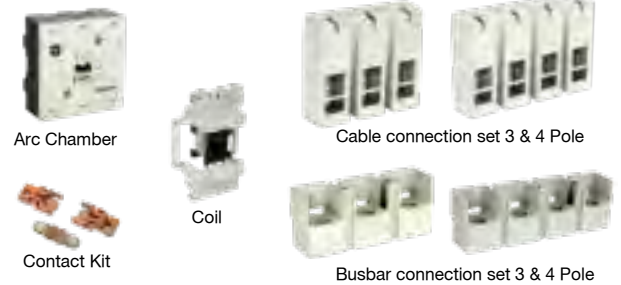

Spare Cable connection sets (115~160), 3P/4P				[HSN Code: 8538]	
Contactor	Reference	MRP (₹)	MOQ		
TC1D115	TA9 D11511603	1010	1		
TC1D120					
TC1D150					
TC1D160					
TC1D115004	TA9 D115604	1370			
TC1D150004					
Spare Arc Chamber (top housing) for 4P Contactors (115-160)					
TC1D115004	TA5 D115450	3410	1		
TC1D150004	TA5 D150450				

AC Coil Voltage				
Contactor	Voltage			
	110	24	220	415
50Hz	F5	B5	M5	N5

☒ Non Stockable item

Note: Stock for accessories are subject to availability.



robustTa Power Contactors

Conforming IEC60947-1 & IEC60947-4-1



Power Contactors with Dust Cover 3 Pole						[HSN Code: 8536]			
AC1 Duty A	AC3 Long Life			With AC Coil		MOQ	With DC Coil		MOQ
	kW	HP	A	Reference	MRP (₹)		Reference	MRP (₹)	
200	59	80	115	LC1FDP115A	27030	1	LC1FDP115A	31780	1
250	80	108	150	LC1FDP150A	37500		LC1FDP150A	46170	
275	100	136	185	LC1FDP185A	44000		LC1FDP185A	56560	
275	105	140	200	LC1FDP200A	48100		LC1FDP200A	57000	
315	110	148	225	LC1FDP225A	49930		LC1FDP225A	62180	
350	140	190	265	LC1FDP265A	61270		LC1FDP265A	66720	
350	150	200	300	LC1FDP300A	66760		LC1FDP300A	78650	
400	180	240	330	LC1FDP330A	73500		LC1FDP330A	88200	
500	220	300	400	LC1FDP400A	85440		LC1FDP400A	105680	
600	240	320	460	LC1FDP460A	112100		-	-	
700	280	380	500	LC1FDP500A	117970		LC1FDP500A	127720	
800	355	430	580	LC1FDP580A	120620		-	-	
1000	375	500	630	LC1FDP630A	174720		LC1FDP630A	196040	
1600	425	580	780	LC1FDP780A	POR		LC1FDP780A	-	
1000	450	610	800	LC1FDP800A	326570		LC1FDP800A*	335390	

- Power Contactors with dust cover 2 Pole variants available on requests
- Power Contactors with dust cover rating 115-800A are supplied factory assembled complete with No-Volt Coil and auxiliary contact block 2NO+2NC.
- *For DC supply, Bypass rectifier and connect DC supply directly to coil terminals A1-A2

Hoisting Power Contactors with dust cover 3 Pole: Rating 115A ~ 630A						Power Contactors with dust cover 4 Pole : Rating AC1 200A ~ 1600A						[HSN Code: 8536]	
AC1 Duty A	AC3 415 V Long Life			With AC Coil		MOQ	AC1 Duty A	Main Pole Configuration	With AC Coil		With DC Coil		MOQ
	kW	HP	A	Reference	MRP (₹)				Reference	MRP (₹)	Reference	MRP (₹)	
200	59	80	115	LC1FDP115HCA	POR	1	200	4 NO	LC1FDP1154	32550	LC1FDP1154	43680	1
250	80	110	150	LC1FDP150HCA			250	4 NO	LC1FDP1504	40920	LC1FDP1504	58470	
275	100	135	185	LC1FDP185HCA			275	4 NO	LC1FDP1854	61590	LC1FDP1854	78190	
315	110	150	225	LC1FDP225HCA			315	4 NO	LC1FDP2254	62980	LC1FDP2254	77100	
350	140	190	265	LC1FDP265HCA			350	4 NO	LC1FDP2654	68200	LC1FDP2654	85530	
355	150	200	300	LC1FDP300HCA			400	4 NO	LC1FDP3304	79260	LC1FDP3304	103040	
400	180	220	330	LC1FDP330HCA			500	4 NO	LC1FDP4004	103250	LC1FDP4004	123460	
500	220	300	400	LC1FDP400HCA			700	4 NO	LC1FDP5004	125070	LC1FDP5004	148800	
700	280	380	500	LC1FDP500HCA			1000	4 NO	LC1FDP6304	241320	LC1FDP6304	249200	
1000	375	500	630	LC1FDP630HCA			1600	4 NO	LC1FDP7804	POR	LC1FDP7804	POR	

Minimum Order Qty. for Hoisting Power Contactors will be 10 Nos.

4 Pole Power Contactors with dust cover rating AC1 200-1600A are supplied factory assembled complete with No-Volt Coil and auxiliary contact block 2NO+2NC.

AC Coil Voltage Codes for Contactors 115A-780A				
Contactor	Voltage			
	110	220	240	415
LC1FDP115-225 50Hz	F5	M5	U5	N5
LC1FDP265-780 50/60Hz	F7	M7	U7	N7

◆ Not Available for LC1FDP780

- Non-Standard coil available on request, Extra MRP@ ₹ 900 each per Contactor rating 115#780A

DC Coil Voltage Codes for Contactors 115A-780A				
Contactor	Voltage			
	24#	48	110	220
LC1FDP	BD	ED	FD	MD

Not available for LC1FDP630 & LC1FDP780

Coil Voltage Codes for Contactor 800A			
Contactor	Voltage		
	110/127	220/240	380/400
LC1-FDP - AC	FW*	MW*	QW**
LC1-FDP-DC	FW	MW	QW

*With rectifier DRTE4U **With rectifier DRTE4S



Capacitor Duty Contactors 3 Pole, AC

Conforming IEC60947-1 & IEC60947-4-1



[HSN Code: 8536]



Size	kVAR Rating	Auxiliary Contacts	Reference	MRP (₹)	MOQ
Frame 1	7	1NO+1NC	TC1D07K11	3160	1
		2NC	TC1D07K02	3160	
	10	1NO+1NC	TC1D10K11	3430	
		2NC	TC1D10K02	3430	
	12.5	1NO+1NC	TC1D12K11	3690	
		2NC	TC1D12K02	3690	
16.7	1NO+1NC	TC1D16K11	5200		
	2NC	TC1D16K02	5200		
Frame 2	20	1NO+1NC	TC1D20K11	5890	
		2NC	TC1D20K02	5890	
	25	1NO+1NC	TC1D25K11	6560	
		2NC	TC1D25K02	6560	
Frame 3	33.3	1NO+2NC	TC1D33K12	11780	
	40	1NO+2NC	TC1D40K12	17600	
	50	1 NO+2NC	TC1D50K12	18140	
	60	1NO+2NC	TC1D60K12	20770	
	75	1NO+2NC	TC1D75K12	24100	
	80	1NO+2NC	TC1D80K12	25840	
	100	1NO+2NC	TC1D100K12	26490	

AC Coil Voltage robusta Capacitor Duty Contactors						
Contactor	Voltage					
TC1-D**K	24	110	220	235	240	415
50Hz	B5	F5	M5	C5W*	U5	N5
50/60Hz	B7	F7	M7	-	U7	N7

* Available upto 25kVAR only.

How to order:

- i) Select applicable Coil Voltage required for Contactor.
- ii) Complete the code by replacing the
- iii) To order additional Auxiliary Block, Timers and other accessories, please refer Page No. 81



robusta Overload Relay

Conforming IEC60947-1, IEC60947-4-1 & IEC60947-5-1



Thermal Overload Relays Direct Mounting Trip class 10 [HSN Code: 8536]								
Relay Setting Range (Amps)	Standard Power Rating for 3 Ph. Motor at 415V		Reference	Suitable for Contactor Rating (Amps)	MRP (₹)	Independent Mounting Kit	MOQ	
	HP	kW						
Direct Mounting								
0.10 ~ 0.16	*	*	☒ TRD09301	9	1980	TA7-D0964 MRP ₹360 [HSN Code: 8538]	1	
0.16 ~ 0.25	*	*	☒ TR2D09302		1980			
0.25 ~ 0.40	*	*	TR2D09303		1980			
0.40 ~ 0.63	*	*	TR2D09304		1980			
0.63 ~ 1.00	0.5	0.37	TR2D09305		1980			
1.00 ~ 1.60	0.75	0.55	TR2D09306		1980			
1.25 ~ 2.00	1	0.75	TR2D093X6		1980			
1.60 ~ 2.50	1.5	1.1	TR2D09307		1980			
2.50 ~ 4.00	2	1.5	TR2D09308		1980			
4.00 ~ 6.00	3	2.2	TR2D09310		1980			
5.50 ~ 8.00	5	3.7	TR2D09312		1980			
7.00 ~ 10.0	5.5	4	TR2D09314		1980			
9.0 ~ 13.0	7.5	5.5	TR2D12316		12			1980
9.0 ~ 14.0	7.5	5.5	TR2D12316X		12			1980
12.0 ~ 18.0	12	9	TR2D18321	18	2390			
14.0 ~ 22.0	12	9	TR2D18321X	18	2390			
17.0 ~ 25.0	15	11	TR2D25322	25	2390			
23.0 ~ 32.0	20	15	TR2D32353	32	3410	TA7-D3264 MRP ₹ 460 [HSN Code: 8538]		
28.0 ~ 36.0	25	18	TR2D32355		3410			
23.0 ~ 32.0	20	15	TR2D40353	40	3710	TA7-D4064 MRP ₹ 1690 [HSN Code: 8538]		
30.0 ~ 40.0	30	22	TR2D40355		3710			
37.0 ~ 50.0	35	25	TR2D65357	50	4780			
48.0 ~ 65.0	40	30	TR2D65359	65	6140			
55.0 ~ 70.0	50	37	TR2D65361		6140			
63.0 ~ 80.0	60	45	TR2D80363	80	6780			
80.0 ~ 93.0	65	49	TR2D95365	95	6840			
Independent Mounting								
65 ~ 105	75	55	LR1F105	-	11000	-	1	
80 ~ 125	80	59	LR1F125		11000			
100 ~ 160	110	80	LR1F160		11000			
125 ~ 200	135	100	LR1F200		11000			
160 ~ 250	175	129	LR1F250		11000			
200 ~ 315	220	160	☒ LR1F315		14110			
250 ~ 400	270	200	☒ LR1F400		14110			
315 ~ 500	350	257	☒ LR1F500		14110			
400 ~ 630	480	355	☒ LR1F630		14110			
500 ~ 800	580	425	☒ LR1F800		40390			
630 ~ 1000	680	500	☒ LR1F1000		40390			

Thermal Overload Relays Protective Shroud for LR1-F105-630 [HSN Code: 8538]			
Relay Type	Reference	MRP (₹)	MOQ
LR1-F105	☒ LA9F702	2400	1
LR1-F125		2400	
LR1-F160		2400	
LR1-F200		2400	
LR1-F250	LA9F703	3160	
LR1-F315		3160	
LR1-F400		3160	
LR1-F500		3160	
LR1-F630	LA9F704	3410	
LR1-F800		3410	

Heavy Duty Overload Relays Independent Mounting Trip class 30 [HSN Code: 8536]			
Relay Setting Range (Amps)	Reference	MRP (₹)	MOQ
2.5-4.0	TR6F4	15480	1
4.0-6.3	TR6F6.3	15480	
6.3-10	TR6F10	15480	
8.0-12.5	TR6F12.5	15480	
10-16	TR6F16	15480	
16-25	TR6F25	15480	
25-40	☒ TR6F40	15480	
40-63	☒ TR6F63	15480	
63-100	☒ TR6F100	15480	
100-160	☒ TR6F160	15480	
125-200	☒ TR6F200	15480	
160-250	☒ TR6F250	15480	
250-400	☒ TR6F400	15480	

☒ Non Stockable item



Accessories for robusTa & Exceed Contactors

Add-On Block for Contactor Rating 9A~800A [HSN Code: 8538]							
Contact Configuration		Reference	MRP (₹)	MOQ			
Front Mounted	1 NO	TA1-DN10*	250	10			
	1 NC	TA1-DN01*					
	2 NO	TA1-DN20	530	20			
	1 NO+1 NC	TA1-DN11					
	2 NC	TA1-DN02					
	4 NO	TA1-DN40					
	Front Mounted	3 NO+1 NC	TA1-DN31	780	20		
		2 NO+2 NC	TA1-DN22				
1 NO+3 NC		TA1-DN13					
4 NC		TA1-DN04					
Side Mounted		1 NO+1 NC	TA8-DN11**			780	10
		2 NO	TA8-DN20**				

* Suitable for robusTa Contactor rating 25~95A only.
 * 25A-38A, 1 Nos can be fitted & for 40-95A, 2 Nos.
 ** Suitable for robusTa Contactor rating 9~95A only & can be used for TC1-D115-160A

Spare AC Coils Control Relay & Contactor 9A-95A [HSN Code: 8538]				
Use for Contactor AC		Reference	MRP (₹)	MOQ
TCA2-DN	TX1-D2 ■		720	20
TC1-D09				
TC1-D12				
TC1-D18				
TC1-D25	TX1-D4 ■		870	10
TC1-D32				
TC1-D40				
TC1-D50	TX1-D6 ■		2280	10
TC1-D63				
TC1-D80				
TC1-D95				

Spare DC Coils Control Relay & Contactor 9A-80A [HSN Code: 8538]				
Use for Contactor DC	Reference		MRP (₹)	MOQ
	Normal	Wideband		
TCA3 - DN	TX4-D2 ■	TX5-D2 ■	1170	1
TP1 - D09				
TP1 - D12				
TP1 - D18	TX4-D4 ■	TX5-D4 ■	1290	1
TP1 - D25				
TP1 - D32				
TP1 - D40				
TP1 - D50	TX4-D40 ■	TX5-D40 ■	3000	1
TP1 - D65				
TP1 - D80				
TP1 - D95	TX4-D80 ■	TX5-D80 ■	6280	1

■ Complete the code for Spare Coil by indicating the Coil Voltage required after the reference *Please refer Page No. 76 for Coil Voltage available

NOTE: Stock for accessories are subject to availability

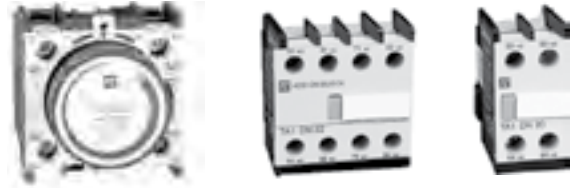

Mechanical Interlocks - Horizontal Mounted [HSN Code: 8538]				
Contact Configuration		Reference	MRP (₹)	MOQ
AC	DC			
TC1-D09	TP1-D09	LA9-D09978	690	10
TC1-D12	TP1-D12			
TC1-D18	TP1-D18			
TC1-D25	TP1-D25			
TC1-D32	TP1-D32	LA9-D50978	1690	10
TC1-D40	TP1-D40			
TC1-D50	TP1-D50			
TC1-D65	TP1-D65			
TC1-D70	TP1-D70			
TC1-D80	TP1-D80	LA9-D80978	2220	10
TC1-D95	TP1-D95			

Pneumatic Timer Block - Front Mounted [HSN Code: 8538]					
Contact Configuration		Reference	MRP (₹)	MOQ	
ON delay	1 NO+1 NC	TA2-DT0	0.1...3s	10	
ON delay	1 NO+1 NC	TA2-DT2	0.1...30s		
ON delay	1 NO+1 NC	TA2-DT4	10...180s		
OFF delay	1 NO+1 NC	TA3-DR0	0.1...3s		
OFF delay	1 NO+1 NC	TA3-DR2	0.1...30s	10	
OFF delay	1 NO+1 NC	TA3-DR4	10...180s		
Star Delta	1 NO+1 NC	TA2-DS2	1...30s	2890	10

Coil Surge Suppressor for Contactor 9-95A [HSN Code: 8538]				
Description	Voltage Ratings	Reference	MRP (₹)	MOQ
Varistor (AC/DC) Clip-on mounting	24~48VAC/DC	TA9AMOV980E	690	10
	110~240V AC/DC	TA9AMOV980U		
	70~150V AC/DC	TA9AMOV980F		
RC Circuit (AC) Clip-on mounting	24~48V AC	TA9RC980E	690	10
	110~240V AC	TA9RC980U		
	380~440V AC	TA9RC980N		

Electrical & Mechanical Interlocks-Horizontal Mounted [HSN Code: 8538]				
Use for Contactor		Reference*	MRP (₹)	MOQ
AC	DC			
TC1-D09	TP1-D09	ELA9-D09978	820	10
TC1-D12	TP1-D12			
TC1-D18	TP1-D18			
TC1-D25	TP1-D25			
TC1-D32	TP1-D32	ELA9-D50978	1840	10
TC1-D40	TP1-D40			
TC1-D50	TP1-D50			
TC1-D65	TP1-D65	ELA9-D80978	2390	10
TC1-D80	TP1-D80			
TC1-D95	TP1-D95			



Accessories

Spare AC Coils for Hoisting Power Contactor [HSN Code: 8538]					
Contactor	110V	220V	240V	415V	MRP (₹)
LC1-FDP115HCA	LX9FF110V	LX9FF220V	LX9FF240V	-	4940
LC1-FDP150HCA					
LC1-FDP185HCA	LX9FG110V	LX9FG220V	LX9FG240V	-	7230
LC1-FDP225HCA					
LC1-FDP265HCA	LX9FH1102V	LX9FH2202V	LX9FH2402V	-	7890
LC1-FDP330HCA					
LC1-FDP400HCA	LX9FJ925	LX9FJ931	LX9FJ932	LX9FJ936	16000
LC1-FDP500HCA	LX9FK925	LX9FK931	LX9FK932	LX9FK936	27050
LC1-FDP630HCA	LX9FL924	LX9FL930	LX9FL931	LX9FL936	27350

NOTE: The above Coil includes rectifier price. Standard Packing 1 No.

Spare AC Coils for Contactors Rating 115-800A [HSN Code: 8538]					
Contactor	110V	220V	240V	415V	MRP (₹)
LC1-FDP115A	LX1FF-110V	LX1FF-220V	LX1FF-240V	LX1FF-415V	3740
LC1-FDP150A					
LC1-FDP185A	LX1FG-110V	LX1FG-220V	LX1FG-240V	LX1FG-415V	6740
LC1-FDP200A					
LC1-FDP225A	LX1FH-1102V	LX1FH-2202V	LX1FH-2402V	LX1FH-4152V	7890
LC1-FDP265A					
LC1-FDP300A	LX1FJ-110V	LX1FJ-220V	LX1FJ-240V	LX1FJ-415V	10490
LC1-FDP330A					
LC1-FDP400A	LX1FK-110V	LX1FK-220V	LX1FK-240V	LX1FK-415V	24970
LC1-FDP500A	LX1FL-110V	LX1FL-220V	LX1FL-240V	LX1FL-415V	25410
LC1-FDP630A	LX1FX-110V	LX1FX-220V	LX1FX-240V	LX1FX-415V	60720
LC1-FDP800A	LX4F8FW	LX4F8MW	LX4F8MW	LX4F8QW*	26650

AC Coils will be suitable for 50Hz only. *Available in 380/400V only

NOTE: The above Coil includes rectifier price. Std. Packing 1 Nos.

Mechanical Interlocks for Contactor 115A-630A Vertically/Horizontally Mounted [HSN Code: 8538]			
Contactor	Reference	MRP (₹)	MOQ
Horizontally Mounted			
LC1-FDP115A	LA9-FF970	4540	1
LC1-FDP150A			
LC1-FDP185A	LA9-FG970	5090	
LC1-FDP200A			
LC1-FDP225A			
LC1-FDP265A	LA9-FJ970	5870	
LC1-FDP300A			
LC1-FDP330A			
LC1-FDP400A			
LC1-FDP500A / LC1-FDPM5004A			
LC1-F630A / LC1-FDP800A	LA9-FL970	5870	
Vertically Mounted			
LC1-FDP115A	LA9-FF4F	5150	1
LC1-FDP150A			
LC1-FDP185A	LA9-FG4G	5430	
LC1-FDP200A			
LC1-FDP225A			
LC1-FDP265A	LA9-FH4H	6690	
LC1-FDP300A			
LC1-FDP330A			
LC1-FDP400A			
LC1-FDP500A/LC1-FDPM5004A	LA9-FK4K	42680	
LC1-FDP800A/LC1-F630A	LA9-FL4L		
LC1-FDP780A	LA9-FX970		

Note: Stock for accessories are subject to availability

Spare DC Coils for Contactors Rating 115A-800A [HSN Code: 8538]					
Contactor	110V	220V	24V	48V	MRP (₹)
LC1-FDP115A	LX4FF-110V	LX4FF-220V	LX4FF-24V	LX4FF-48V	12230
LC1-FDP150A					
LC1-FDP185A	LX4FG-110V	LX4FG-220V	LX4FG-24V	LX4FG-48V	15670
LC1-FDP225A					
LC1-FDP265A	LX4FH-110V	LX4FH-220V	LX4FH-24V	LX4FH-48V	19100
LC1-FDP330A					
LC1-FDP400A	LX4FJ-110V	LX4FJ-220V	Not Available	LX4FJ-48V	30570
LC1-FDP500A	LX4FK-110V	LX4FK-220V	Not Available	LX4FK-48V	33720
LC1-FDP630A	LX4FL-110V	LX4FL-220V	Not Available	LX4FL-48V	39490
LC1-FDP780A	•	LX4FX-220V	•	•	36330
LC1-FDP800A	LX4F8FW	LX4F8MW	-	LX4F8QW*	32500

NOTE: The above Coil includes rectifier price. Standard Packing 1 No.

•Contact Branch Office for product code. *Available in 380/400V only.

Spare Top Housing for 3P/4P robusTa Contactors [HSN Code: 8538]					
For Control Relay Contactor	Reference		MRP (₹)	MOQ	
	AC	DC			
For 3 Pole					
TCA2-DN40, TCA3-DN40	TA5-DN40	TA5-DN40 DC	1350	1	
TCA2-DN31, TCA3-DN31	TA5-DN31	TA5-DN31 DC			
TCA2-DN22, TCA3-DN22	TA5-DN22	TA5-DN22 DC			
TC1-D0910, TP1-D0910	TA5-D0910	TA5-D0910 DC			
TC1-D0901, TP1-D0901	TA5-D0901	TA5-D0901 DC			
TC1-D1210, TP1-D1210	TA5-D1210	TA5-D1210 DC			
TC1-D1201, TP1-D1201	TA5-D1201	TA5-D1201 DC			
TC1-D1810, TP1-D1810	TA5-D1810	TA5-D1810 DC			
TC1-D1801, TP1-D1801	TA5-D1801	TA5-D1801 DC			
TC1-D2210, TP1-D2210	TA5-D2210	TA5-D2210 DC			
TC1-D2201, TP1-D2201	TA5-D2201	TA5-D2201 DC	1920	1	
TC1-D2510, TP1-D2510	TA5-D2510	TA5-D2510 DC			
TC1-D2501, TP1-D2501	TA5-D2501	TA5-D2501 DC	2060	1	
TC1-D3210, TP1-D3210	TA5-D3210	TA5-D3210 DC			
TC1-D3201, TP1-D3201	TA5-D3201	TA5-D3201 DC	3760	1	
TC1-D3810, TP1-D3810	TA5-D3810	TA5-D3810 DC			
TC1-D3801, TP1-D3801	TA5-D3801	TA5-D3801 DC	5510	1	
TC1-D4011, TP1-D4011	TA5-D4011	TA5-D4011 DC			
TC1-D5011, TP1-D5011	TA5-D5011	TA5-D5011 DC	5650	1	
TC1-D5011, TP1-D5011	TA5-D5011	TA5-D5011 DC			
TC1-D6511, TP1-D6511	TA5-D6511	TA5-D6511 DC	7020	1	
TC1-D6511, TP1-D6511	TA5-D6511	TA5-D6511 DC			
TC1-D7011, TP1-D7011	TA5-D7011	TA5-D7011 DC	9660	1	
TC1-D7011, TP1-D7011	TA5-D7011	TA5-D7011 DC			
TC1-D8011, TP1-D8011	TA5-D8011	TA5-D8011 DC	10300	1	
TC1-D8011, TP1-D8011	TA5-D8011	TA5-D8011 DC			
TC1-D9511, TP1-D9511	TA5-D9511	TA5-D9011 DC	11420	1	
TC1-D9511, TP1-D9511	TA5-D9511	TA5-D9011 DC			
TC1-D9511, TP1-D9511	TA5-D9511	TA5-D9011 DC	13290	1	
TC1-D9511, TP1-D9511	TA5-D9511	TA5-D9011 DC			
For 4 Pole					
TC1-D09004, TP1-D09004	TA5-D09004	TA5-D09004DC	1710	1	
TC1-D09008, TP1-D09008	TA5-D09008	TA5-D09008DC			
TC1-D12004, TP1-D12004	TA5-D12004	TA5-D12004DC			
TC1-D12008, TP1-D12008	TA5-D12008	TA5-D12008DC			
TC1-D25004, TP1-D25004	TA5-D25004	TA5-D25004DC			
TC1-D25008, TP1-D25008	TA5-D25008	TA5-D25008DC			
TC1-D40004, TP1-D40004	TA5-D40004	TA5-D40004DC			
TC1-D40008, TP1-D40008	TA5-D40008	TA5-D40008DC			
TC1-D65004, TP1-D65004	TA5-D65004	TA5-D65004DC			
TC1-D65008, TP1-D65008	TA5-D65008	TA5-D65008DC			
TC1-D80004, TP1-D80004	TA5-D80004	TA5-D80004DC	12880	1	
TC1-D80004, TP1-D80004	TA5-D80004	TA5-D80004DC			

MOQ- Minimum Order Quantity



Accessories

Spare Top Housing for 3P exceed Contactors [HSN Code: 8538]			
For Control Relay Contactor	Reference AC	MRP (₹)	MOQ
TCA2-DN40E	TA5-DN40E	1050	1
TCA2-DN31E	TA5-DN31E		
TCA2-DN22E	TA5-DN22E		
TC1D0901E	TA5-D0901E		
TC1D0910E	TA5-D0910E		
TC1D1201E	TA5-D1201E		
TC1D1210E	TA5-D1210E		
TC1D1801E	TA5-D1801E	1230	
TC1D1810E	TA5-D1810E		
TC1D2501E	TA5-D2501E	1480	
TC1D2510E	TA5-D2510E		
TC1D4011E	TA5-D4011E	3840	
TC1D5011E	TA5-D5011E	5270	
TC1D6511E	TA5-D6511E	7360	
TC1D8011E	TA5-D8011E	9680	
TC1D9511E	TA5-D9511E	10520	

Spare Arc Chamber 3P [HSN Code: 8538]			
Contactor	Reference	MRP (₹)	MOQ
LC1-FDP115A	LA5-F11550	3790	1
LC1-FDP150A	LA5-F15050		
LC1-FDP185A	LA5-F18550	4060	
LC1-FDP200A	LA5-F20050	4130	
LC1-FDP225A	LA5-F22550	4160	
LC1-FDP265A	LA5-F26550	4540	
LC1-FDP300A	LA5-F30050	5700	
LC1-FDP330A	LA5-F33050	6130	
LC1-FDP400A	LA5-F40050	6540	
LC1-FDP500A	LA5-F50050	7300	
LC1-FDP630A	LA5-F63050	16970	
LC1-FDP780A	LA5-F780150*	POR	

Spare Main Contact for 3P Contactors Rating 115A-800A [HSN Code: 8538]			
Contactor	Reference	MRP (₹)	MOQ
LC1-FDP115A	LA5-FF431 (F115)	13110	1
LC1-FDP150A	LA5-FF431 (F150)	18150	
LC1-FDP185A	LA5-FG431 (F185)	22800	
LC1-FDP200A	LA5-FG431 (F200)	26790	
LC1-FDP225A	LA5-FG431 (F225)	29980	
LC1-FDP265A	LA5-FH431 (F265)	32000	
LC1-FDP300A	LA5-FH431 (F300)	33410	
LC1-FDP330A	LA5-F400803 (F330)	35900	
LC1-FDP400A	LA5-F400803 (F400)	45070	
LC1-FDP500A	LA5-F500803 (F500)	59830	
LC1-FDP630A	LA5-F630803 (F630)	84970	
LC1-FDP780A	LA5F780801(F7804)	47800	
LC1-FDP800A	LA5F800803(F800)	95300	

Spare Arc Chamber 4P [HSN Code: 8538]			
Contactor	Reference	MRP (₹)	MOQ
LC1-FDP1154A	LA5-F115450	3890	1
LC1-FDP1504A	LA5-F150450		
LC1-FDP1854A	LA5-F185450	5490	
LC1-FDP2254A	LA5-F225450	5730	
LC1-FDP2654A	LA5-F265450	6850	
LC1-FDP3304A	LA5-F330450	7230	
LC1-FDP4004A	LA5-F400450	9010	
LC1-FDPM5004A	LA5-F500450	10350	
LC1-FDP6304A	LA5-F630450	20710	
LC1-FDP7804A	LA5-F780150*	13150	
LC1-FDP8004A	LA5-F80050	20810	

Spare Main Contact Sets for 4P Power Contactors Rating 115A-780A [HSN Code: 8538]			
Contactor	Reference	MRP (₹)	MOQ
LC1-FDP1154A	LA5-FF441 (F1154)	15360	1
LC1-FDP1504A	LA5-FF441 (F1504)	22870	
LC1-FDP1854A	LA5FG441(F1854)	33730	
LC1-FDP2254A	LA5FG441(F2254)	35240	
LC1-FDP2654A	LA5-FH441 (F2654)	37700	
LC1-FDP3304A	LA5-F400804 (F3304)	45600	
LC1-FDP4004A	LA5-F400804 (F4004)	51880	
LC1-FDPM5004A	LA5-F500804 (F5004)	81860	
LC1-FDP6304A	LA5-F630804 (F6304)	104830	
LC1-FDP7804A	LA5-F780801 (F780)	47170	

*Coil Surge Suppressor - Contactor 115-630A [HSN Code: 8538]			
Description	Reference	MRP (₹)	MOQ
Coil Surge Suppressor for LC1FDP115-630A (3P/4P)	LA9F980(BR)*	3010	5

* Common for Exceed & Robusta Contactors.
 * Only for 220V AC

- Complete spare main contact set available as per pole.
 - Main contact set per pole includes (2 Fixed contacts & 1 Moving contact, 2 Deflector, 1 Flat pole spring, 2 Fixing screws, 2 Washer).
 * Stock for accessories are subject to availability

Front Mount Add on block with IP67

Robusta TA2 contactors			[HSN Code: 8538]		
Reference Item	Pole Configuration	MRP (₹)	Reference Item	Pole Configuration	MRP (₹)
TA1DX11	11	1530	TA1DX11 N11	X11 N11	1720
TA1DX20	20	1530	TA1DX11 N20	X11 N20	1720
TA1DX02	02	1530	TA1DX11 N02	X11 N02	1730
TA1DX20 N20	X20 N20	1720	TA1DX02 N11	X02 N11	1720
TA1DX20 N11	X20 N11	1720	TA1DX02 N20	X02 N20	1720
TA1DX20 N02	X20 N02	1730	TA1DX02 N02	X02 N02	1730

**NOTE :- "X" DENOTES IP67
"N" DENOTES NORMAL CONTACTS**

FOR EXAMPLE:- TA1D(X)02 (N)20

ADD ON BLOCK SERIES | IP67 | NORMAL CONTACT

NO CONTACT ('2' NC)
NC CONTACT ('0' NC)

IP [] []

The first digit shows the level of protection against solid objects

The second digit shows the level of protection against liquids

6 Complete dust protection (No ingress of dust)

7 Protected against submersion in water under defined conditions of pressure and time

7 Harmful ingress of water when immersed between a depth of 150 to 1000mm (5.9~40 In)

Compatible products

- 9A-800A Robusta & Exceed 3 Pole & 4 Pole Contactors
- 9A-90A D-Range Contactors
- 1250A to 2600A Robusta 3 Pole Contactors

Spare AC Coils for Contactors Rating 115A to 2600A					
Contactors	110V	220V	240V	415V	MRP (₹)
LC1-FDP1250A	LX1FL110V	LX1FL220V	LX1FL240V	LX1FL415V	25410
LC1-FDP1400A	LX1FK065V	LX1FK110V	LX1FK127	LX1FK220V	24970
LC1-FDP1700A					
LC1-FDP2100A					
LC1-FDP2600A	LX1FL065V	LX1FL110V	LX1FL127V	LX1FL220V	25410

* For 1400A-2600A 2 Nos required for each contactor
* For 1250A 1 Nos required for each contactor

Spare DC Coils for Contactors Rating 115A to 2600A					
Contactors	110V	220V	240V	415V	MRP (₹)
LC1-FDP1250A	LX4FL110V	LX4FL220V	-	LX4FL48V	39490
LC1-FDP1400A	LX4FK055V	LX4FK110V	-	-	33720
LC1-FDP1700A					
LC1-FDP2100A					
LC1-FDP2600A	LX4FL055V	LX4FL110V	-	-	39490

* For 1400A-2600A 2 Nos required for each contactor
* For 1250A 1 Nos required for each contactor

* Stock for accessories are subject to availability. MOQ- Minimum Order Quantity



D Range Contactors & Overload Relays

Conforming IEC60947-1, IEC60947-4-1 & IEC60947-5-1



Control Relays 10 Amps		[HSN Code: 8536]	
Contact Configuration	A.C. Reference	MRP (₹)	MOQ
2NO+2NC	CA2DN1229	1660	1
3NO+1NC	CA2DN1319		
4NO	CA2DN140		

■ Please specify Coil Voltage.

Power Contactors - 3 Pole, AC							[HSN Code: 8536]	
Size	AC1 Duty A	AC3 415V Long Life			Auxiliary Contacts	Reference	MRP (₹)	MOQ
		KW	HP	A				
Frame 1	25	4	5.5	9	1NO -	LC1D093	1540	1
					- 1NC	LC1D099	1540	
	25	5.5	7.5	12	1NO -	LC1D123	1730	
					- 1NC	LC1D129	1730	
	32	9	12.5	16	1NO -	LC1D173	2030	
					- 1NC	LC1D179	2030	
	32	11	15	22	1NO -	LC1D223	2340	
					- 1NC	LC1D229	2340	
Frame 2	40	11	15	25	1NO -	LC1D253	2710	
					- 1NC	LC1D259	2710	
	50	15	20	32	1NO -	LC1D323	5520	
					- 1NC	LC1D329	5520	
Frame 3	60	22	30	40	1NO 1NC	LC1D403	8100	
	80	25	35	50	1NO 1NC	LC1D503	9720	
	80	37	50	63	1NO 1NC	LC1D633	13700	
	125	45	60	80	1NO 1NC	LC1D803	17200	

☒ Non Stockable item
MOQ - Minimum Order Quantity

AC Coil Voltage Codes for D Range Contactors (Standard)						
Contactor	Voltage					
	24	48	110*	220*	240*	415*
LC1-D	B	E	F	M	U	N

* Coils also available in wide band.

* Stock for accessories are subject to availability

Thermal Overload Relays Type LR1-Direct Mounting [HSN Code: 8536]						
Relay Setting Range A	Std. Power Rating for 3 Phase Motor at 415V		Reference	MRP (₹)	MOQ	
	HP	KW				
0.10-0.16	*	*	☒ LR1D09301	2010	10	
0.16-0.25	*	*	☒ LR1D09302			
0.25-0.40	*	*	LR1D09303			
0.40-0.63	*	*	LR1D09304			
0.63-1.00	0.5	0.37	LR1D09305			
1.00-1.60	0.75	0.55	LR1D09306			
1.60-2.50	1.5	1.10	LR1D09307			
2.50-4.00	2.00	1.50	LR1D09308			
4.00-6.00	3.00	2.20	LR1D09310			
5.50-8.00	5.00	3.70	LR1D09312			
7.00-10.0	5.50	4.00	LR1D09314			
10.0-13.0	7.50	5.50	LR1D12316			
13.0-18.0	12.00	9.00	LR1D16321			2410
18.0-25.0	15.00	11.00	LR1D25322			
23.0-32.0	20.00	15.00	LR1D32353	3460		
28.0-40.0	20.00	15.00	LR1D32355			
23.0-32.0	20.00	15.00	LR1D40353	3800		
30.0-40.0	30.00	22.00	LR1D40355			
38.0-50.0	35.00	25.00	LR1D63357	4400		
48.0-57.0	40.00	30.00	LR1D63359	6240		
57.0-66.0	50.00	37.00	LR1D63361	6880		

* There is no standard power rating for these motors. Select the overload relay in relation to the full load current.

AC Coil Voltage Codes for D Range Contactors (Non-Standard)			
Contactor	Voltage		
	42	360	380
LC1-D	D	UW	Q

For Non-Standard Coil Voltage, please add ₹ 180/- in the MRP.

Thermal OLR Type LR1-Independent Mounting [HSN Code: 8536]					
Relay Setting Range A	Std. Power Rating for 3 Phase Motor at 415V		Reference	MRP (₹)	MOQ
	HP	KW			
66.0to80.0	60	45	LR1-D80363	6850	1

Consisting of 1 NO+1 NC make before break contacts.



Accessories



Add-on-Blocks for D Range Contactors [HSN Code: 8538]					
Contactor		Reference	MRP (₹)	MOQ	
Additional Instantaneous Aux. Contact Blocks	Front Mounted	2 NO	LA1D20	490	20
		1 NO+1 NC	LA1D11		
		2 NC	LA1D02		
		4 NO	LA1D40	740	
		3 NO+1 NC	LA1D31		
		2 NO+2 NC	LA1D22		
		1 NO+3 NC	LA1D13		
		4 NC	LA1D04		
Overlapping Aux. Contacts	Front Mounted	2 NO+2 NC	LA1D1111#	1060	10

Spare AC Coil Voltage for D Range Contactors AC (Standard) [HSN Code: 8538]			
Use for Contactor AC (Standard)	Reference	MRP (₹)	MOQ
CA2-DN1	☒ LX1-D09	740	15
LC1-D09			
LC1-D12			
LC1-D17	☒ LX1-D25	880	10
LC1-D25			
LC1-D32			
LC1-D40	☒ LX1-D40	2180	10
LC1-D50**			
LC1-D63			
LC1-D80**			

■ Please specify Coil Voltage by indicating the Coil Voltage required.
 ** Spare Moulded Base for these Coils has Product code LA7-D40 and unit price is ₹220

D Range Mechanical Interlocks Horizontally Mounted [HSN Code: 8538]			
Use for Contactor AC	Reference	MRP (₹)	MOQ
LC1-D09	LA9-D09978	690	10
LC1-D12			
LC1-D17			
LC1-D22			
LC1-D25			
LC1-D32			
LC1-D40	LA9-D50978	1690	
LC1-D50			
LC1-D63			
LC1-D80	LA9-D80978	2220	

Spare Top Housing 3P [HSN Code: 8538]			
For Control Relay/Contactor AC	Reference	MRP (₹)	MOQ
CA2-DN140	LA5-DN140	1280	
CA2-DN1319	LA5-DN1319		
CA2-DN1229	LA5-DN1229		
LC1-D093	☒ LA5-D093	1460	
LC1-D099	LA5-D099		
LC1-D123	☒ LA5-D123	1580	
LC1-D129	LA5-D129		
LC1-D173	LA5-D173	2070	1
LC1-D179	☒ LA5-D179		
LC1-D223	LA5-D223		
LC1-D229	LA5-D229	4120	
LC1-D253	☒ LA5-D253		
LC1-D259	☒ LA5-D259	6380	
LC1-D323	☒ LA5-D323		
LC1-D329	LA5-D329	7830	
LC1-D403	☒ LA5-D403		
LC1-D503	☒ LA5-D503	10090	
LC1-D633	LA5-D633		
LC1-D803	LA5-D803	13170	

Coil Suppressor [HSN Code: 8538]			
Description	Reference	MRP (₹)	MOQ
For mounting across coil of contactor upto 80Amp, with C network suitable for <250V AC & <400V AC	LA9-D09980	740	10



* Stock for accessories are subject to availability

Accessories



Add-on Starting Switch		[HSN Code: 8538]	
Description	Reference	MRP (₹)	MOQ
NO starting Switch suitable for direct mounting on Control Relays & Contactors	LA9-D09906	240	10



Mechanical Latching Blocks		[HSN Code: 8538]	
Description for Contractors / Control Relays Type	Reference	MRP (₹)	MOQ
CA2-DN1 LC1-D09, LC1-D12 LC1-D17, LC1-D25, LC1-D32	 LA6-DK01 	2990	10

 Replace by voltage code

AC Coil Voltage Codes (Standard)								
For Mechanical Latching Block	Voltage							
	24	48	72	110	220	240	380	415/440
LA6-DK01	B	E	EN	F	M	U	Q	N

* Stock for accessories are subject to availability

Contactors - 2 Pole & 4 Pole, AC

Conforming IEC60947-1, IEC60947-4-1



Contactors - 4 Pole, AC [HSN Code: 8536]						
AC3, 415V			Main Poles Configuration	Reference	MRP (₹)	MOQ
kW	HP	A				
7.5	10	20	4NO	TC1DX204	4090	1
11	15	25	4NO	TC1DX254	6010	
22	30	40	4NO	TC1DX404	9770	

■ Please specify Coil Voltage.

AC Coil Voltage Codes (Standard) for 4 Pole Contactors				
Contactor 4P	Voltage			
	110	220	190~400	250~450
TC1-DX204/254	F	M	Q	N

Spare Coil for 4 Pole Contactors [HSN Code: 8538]			
Reference	Coil Voltage	MRP (₹)	MOQ
TX1D20	110/220/190~400/250~450	700	1

Spare Contact Kit for 4 Pole Contactor [HSN Code: 8538]			
Reference	Description	MRP (₹)	MOQ
TA5DX204	20A Contact Kit, 4-Pole	1330	1
TA5DX254	25A Contact Kit, 4-Pole	2300	
TA5DX404	40A Contact Kit, 4-Pole	3730	

Add-on-Blocks for 4 Pole Contactors [HSN Code: 8538]				
Description	Contact Configuration	Reference	MRP (₹)	MOQ
Front mounted Aux. contact Block	1 NO+1 NC	TA1-DN11A	540	2

Note : Also available with 2NC.

Mechanical Interlock for 4 Pole Contactors [HSN Code: 8538]			
Description	Reference	MRP (₹)	MOQ
Horizontal Mounted	LA9-D09978	650	10

Contactors - 2 Pole, AC [HSN Code: 8536]					
AC1 Duty	AC3 220V AC		Reference	MRP (₹)	MOQ
	A				
32	20		AC2-D202	1600	2
40	25		AC2-D252	2180	
40	40		AC2-D402	2980	

AC Coil Voltage Codes (Standard) for 2 Pole Contactors			
Contactor 2P	Voltage		
	220*	220/240*	380 / 415*
AC2-D2/D3/D4	M5W	MU	QN

* Wide band Coils ■ Please specify Coil Voltage.

Spare Coil for 2 Pole Contactors [HSN Code: 8538]			
Reference	Coil Voltage	MRP (₹)	MOQ
AX1D2 MU	220/240V, 50Hz	470	5
AX1D2 M	220V, 50Hz		
AX1D2 QN	380/415V, 50Hz		
AX1D2 N	415V, 50Hz		

Spare Contact Kit for 2 Pole Contactor [HSN Code: 8538]			
Reference	Description	MRP (₹)	MOQ
AC5D202	20A Contact Kit, 2-Pole	710	1
AC5D252	25A Contact Kit, 2-Pole	1420	
AC5D402	40A Contact Kit, 2-Pole	1730	
☒ AC5D2011	20A Contact Kit, 1NO+1NC	740	

Add-on-Blocks for 2 Pole Contactors [HSN Code: 8538]				
Description	Contact Configuration	Reference	MRP (₹)	MOQ
Front mounted Aux. contact Block	2 NO 1 NO+1 NC 2 NC	LA1-D20A	500	20
		LA1-D11A		
		☒ LA1-D02A		

Thermal OLR 2 Pole type LR7D-Direct Mounting [HSN Code: 8536]				
Relay Setting Range (A)	Reference	MRP (₹)	Independent Mounting Kit	MOQ
4.0-6.0	LR7D09210	770	LA7D0964 MRP ₹320 [HSN Code: 8538]	1
5.5-8.0	LR7D09212			
7.0-10	LR7D09214			
9.0-14	LR7D12216X	930		
13-18	LR7D16221			
14-22	LR7D16221X			
18-25	LR7D25222	1130		
23-32	LR7D32253			

☒ Non Stockable item



New Agro 4 Pole Contactor Series

Available in 2 Unique flexible models:

- Front opening model
- Rear opening model
- Front mounted Add-on block option.
- Easy field replaceable fixed / moving contact Easy maintenance
- Wide band encapsulated magnet coil. Easy replacement
- Common spare kits, coils, accessories in both models
- Flexible design permits change in coil and contacts locally
- Contactor conforming to IEC 60947-4-1
- Thick inter-phase molding walls with liberal clearance & creepage minimizes phase shorting risk



New Agro Contactors - Front Opening					[HSN Code: 8536]	
AC1 Duty		AC3 415V Long life			Reference	MRP (₹)
A	KW	HP	A			
25	7.5	10	16	TC1DXN164*	3220	
32	9	12.5	20	TC1DXN204*	3900	
40	11	15	25	TC1DXN254*	5720	
45	15	20	32	TC1DXN324*	7200	
50	18.5	25	40	TC1DXN404*	9120	

New Agro Contactors - Rear Opening					[HSN Code: 8536]	
AC1 Duty		AC3 415V Long life			Reference	MRP (₹)
A	KW	HP	A			
25	7.5	10	16	TC1DXRN164*	3300	
32	9	12.5	20	TC1DXRN204*	3980	
40	11	15	25	TC1DXRN254*	5840	
45	15	20	32	TC1DXRN324*	7350	
50	18.5	25	40	TC1DXRN404*	9300	

Spare Contact Kit Codes		
Combination	Reference	MRP (₹)
16A CONTACT KIT, 4 - POLE	TA5DXN164	1240
20A CONTACT KIT, 4 - POLE	TA5DXN204	1250
25A CONTACT KIT, 4 - POLE	TA5DXN254	POR
32A CONTACT KIT, 4 - POLE	TA5DXN324	
40A CONTACT KIT, 4 - POLE	TA5DXN404	3190

C&S Standard Coil Voltages		
* Coil Code	Coil Voltage	Common for both Front & Rear opening
B	24V, 50 Hz	
E	48V, 50 Hz	
F	110V, 50 Hz	
MU	220/240V, 50 Hz	
QN	380/415V, 50 Hz	

Spare Coil Codes		
* Coil Code	Coil Voltage	MRP (₹)
TX1DN30N	415V 50Hz	670
TX1DN30Q	380V 50Hz	
TX1DN30QN	380/415V 50Hz	
TX1DN30M	220V 50Hz	
TX1DN30MU	220/240V 50Hz	
TX1DN30F	110V 50Hz	
TX1DN30E	48V 50Hz	
TX1DN30B	24V 50Hz	

Auxiliary Block		
Combination	Reference	MRP (₹)
1NO + 1NC	TA1DXN11	530
2NO	TA1DXN20	
2NC	TA1DXN02	

- Stock for accessories are subject to availability

* Indicates Coil Code

 Non Stockable item

MOQ- Minimum Order Quantity

Definite Purpose Contactor

Conforming IEC60947-1, IEC60947-4-1

GLOBAL CERTIFICATION



Contactor				[HSN Code: 8536]
FLA	Resistive AMP Rating	Reference	MRP (₹)	MOQ
Single Pole (Without Shunt)				
25	30	☒TCDP251	1110	1
30	40	☒TCDP301	1180	
40	50	☒TCDP401	1240	
Single Pole (With Shunt)				
25	30	TCDP251S	1160	1
30	40	TCDP301S	1220	
40	50	TCDP401S	1330	
Two Pole				
20	30	TCDP202	1270	1
30	40	TCDP302	1280	
40	50	☒TCDP402	1370	
Three Pole				
20	30	TCDP203	1510	1
30	40	TCDP303	1550	
40	50	☒TCDP403	1760	

AC Coil Voltage Codes for Definite Purpose Contactors

Voltage	24VAC	110VAC	240VAC
50Hz	B5	G5	U5
60Hz	B6	G6	U6

DT-Series 4 Pole Rating AC1 25A-63A

[HSN Code: 8536]

AC1 Duty A	Main Pole Configuration	With AC Coil		MOQ
		Reference	MRP (₹)	
25	4 NO	TC1DT254Ne	POR	1
32	4 NO	☒TC1DT324Ne		
32	2 NO+2 NC	TC1DT328Ne		
40	4 NO	☒TC1DT404Ne		
50	4 NO	TC1DT504Ne		
45	4 NO	TC1DT45004E		
45	2 NO+2 NC	TC1DT45008E		
50	4 NO	TC1DT50004E		
50	2 NO+2 NC	TC1DT50008E		
63	4 NO	TC1DT63004E		
63	2 NO+2 NC	TC1DT63008E		

AC Coil for 4 Pole Telecom Contactor

Contactor	Voltage			
TC1-DT**Ne	230	235	240	415
50Hz	P	C5W	M	N

All coils codes applicable for extra wide band coils.

* Stock for accessories are subject to availability

☒ Non Stockable item

MOQ- Minimum Order Quantity

Industrial Plugs & Sockets



IEC 60309 Series
IP44 & IP67 Protection

BENEFITS

- Safety through interchangeability
- High grade thermo plastic material assures:
 - Exceptional high impact resistance
 - High thermal stability
 - High insulated Quality
 - Good resistance to various chemicals
- Colour codes for easy identification of Plug & Sockets
- Locking device prevent unintended withdrawl

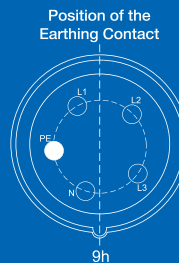
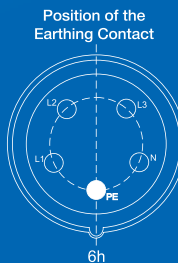

Control & Signalling Devices

Metallic & Polycarbonate Series



Push Buttons & Pilot Lamps

- Ø22.5 mm Push Buttons, Emergency Stop PB, Selector switch
Illuminated & Non Illuminated Actuators in Plastic & Metallic variants
- Pilot Lamps in LED / Filament / Neon types
- Push Button Stations 1/2/3/4 ways, IP65 / 166, NEMA-41/X protection
- High Mechanical and Electrical life
- Aesthetic and Elegant outlook
- Wide Range of colors I voltages available

Globally accepted



IEC 60309 Series

[HSN Code: 8536]

IP 44 & IP 67 Versions	Description	Rating (Amp)	Protection Degree	3 PIN, 2P+E 240V AC			4 PIN, 3P+E 415V AC			5 PIN, 3P+N+E 415V AC		
				Code	MRP (₹)	Reference h	Code	MRP (₹)	Reference h	Code	MRP (₹)	Reference h
	Panel Mounting Socket - Splash Proof	16	IP44	CS62205*	660	6	-	-	-	CS62210*	1100	6
		32		CS62216*	1130	6	-	-	-	CS62221*	1270	6
	Panel Mounting Socket - Water Tight	16	IP67	CS62227	1420	6	-	-	-	CS62232	1510	6
		32		CS62238	1530	6	-	-	-	CS62243	2000	6
		63		<input checked="" type="checkbox"/> CS63249	5620	6	-	-	-	CS63254	5160	6
		125		-	-	-	-	-	-	CS62262	19330	6
	Surface Mounting Socket - Splash Proof	16	IP44	CS62404	1090	6	-	-	-	CS62409	1190	6
		32		CS62415	1350	6	-	-	-	CS62420	1430	6
	Surface Mounting Socket - Water Tight	16	IP67	CS62426	1840	6	-	-	-	<input checked="" type="checkbox"/> CS62431	2410	6
		32		<input checked="" type="checkbox"/> CS62437	2300	6	<input checked="" type="checkbox"/> CS62283	2580	3	CS62442	2770	6
		63		<input checked="" type="checkbox"/> CS63448	7090	6	-	-	-	CS63453	7270	6
		125		-	-	-	-	-	-	<input checked="" type="checkbox"/> CS63463	25040	6
	Plugs - Splash Proof	16	IP44	CS60004*	570	6	-	-	-	CS60009*	760	6
		32		CS60015*	910	6	-	-	-	CS60020*	1100	6
	Plugs - Water Tight	16	IP67	CS60026	1220	6	-	-	-	CS60031	1610	6
		32		CS60037	1890	6	CS60145	1930	3	CS60042	1970	6
		63		<input checked="" type="checkbox"/> CS61048	5340	6	-	-	-	CS61053	5520	6
		125		-	-	-	-	-	-	CS60061	16400	6
	Surface Mounting Interlocked Switched Socket Outlet - Horizontal	16	IP44	CS66004(H)	8660	6	-	-	-	<input checked="" type="checkbox"/> CS66109(H)	11040	6
		32		<input checked="" type="checkbox"/> CS66015(H)	10300	6	-	-	-	<input checked="" type="checkbox"/> CS66020(H)	12340	6
	Surface Mounting Interlocked Switched Socket Outlet - Vertical	16	IP67	CS66200	9490	6	-	-	-	<input checked="" type="checkbox"/> CS66202	13440	6
		32		<input checked="" type="checkbox"/> CS66201	13260	6	-	-	-	<input checked="" type="checkbox"/> CS66203	16030	6
	Connector - Splash Proof	16	IP44	CS62004*	830	6	-	-	-	<input checked="" type="checkbox"/> CS66215*	950	-
		32		CS62015*	1050	6	-	-	-	CS66225*	1340	-
	Connector Water Tight	32	IP67	-	-	-	CS62128	2580	3	-	-	

Note: Plugs & Sockets 3 PIN, 2P+E 240V AC are in Blue color, 5 PIN, 3P+N+E 415V AC are in Red color

[HSN Code: 8536]

AC Distribution Box with Socket	Description	Rating (Amp)	Protection Degree	Code	MRP (₹)	Reference h
	AC Distribution Box (Includes Socket & Plug)	16A 3P 240V	IP40	CS60045*	2050	6
		32A 3P 240V		CS60046*	2530	6
		32A 5P 415V		CS60047*	3800	6
		63A 5P 415V		CS60048*	9890	6

* Stock for accessories are subject to availability











Non Stockable item
MOQ- Minimum Order Quantity





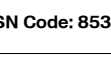

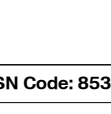

GLOBAL CERTIFICATION



Push Buttons: 22.5mm
Without Contact Elements

Push Button Actuators with Carrier-Non-Illuminated		[HSN Code: 8536]		
Description	Reference	MRP (₹)	MOQ	Product Picture
Push Spring Return Push Button	RCP2-BA1○	120	20	
	☒ RCP2-BA2●			
	RCP2-BA3●			
	RCP2-BA4●			
	RCP2-BA5●			
	☒ RCP2-BA6●			
Flush Spring Return Push Button with contact	☒ RCP2BA33●	270	10	
	RCP2BA35●			
Projecting Push Button	RCP2-BL1○	120	20	
	RCP2-BL2●			
	RCP2-BL3●			
	RCP2-BL4●			
	RCP2-BL5●			
	RCP2-BL6●			
Mushroom Head Push Button, Spring Return	RCP2-BC2●	170	8	
	RCP2-BC3●			
	☒ RCP2-BC4●			
	RCP2-BC5●			
	RCP2-BC6●			
	RCP2-BC6●			
Mushroom Head Push Button, Spring Return with contact	RCP2-BC21●	250	8	
	RCP2-BC31●			
	☒ RCP2-BC42●			
	RCP2-BC51●			
	RCP2-BC61●			
Mushroom Head ∅40mm Push Button Stay Put turn to release	RCP2BS54●	230	8	
Mushroom Head ∅40mm Push Button Stay Put turn to release	RCP2BT4●			
Mushroom Head ∅60mm Push Button Stay Put turn to release	RCP2BS64●	340	5	
Mushroom Head Push Button, Push to Stay & Key to release	RCP2BS14●	460	8	
Push Button Stay Put ∅30mm (Press to Lock turn to release)	RCP2BS44●	220	10	
Push Button Actuators with Carrier & Contact Element-Non-Illuminated		[HSN Code: 8536]		
Flush Spring Return Push Button with 1NO Block	☒ RCP2-BA11○	180	10	
	☒ RCP2-BA21●			
	RCP2-BA31●			
	RCP2-BA51●			
	RCP2-BA61●			
	RCP2-BA41●			
Push Button with 1NC Block	RCP2-BA42●			
	RCP2-BA42●			
Projecting Head Push Button with 1NO Block	RCP2-BL11○	180	10	
	RCP2-BL21●			
	☒ RCP2-BL31●			
	RCP2-BL51●			
	RCP2-BL61●			
Projecting PB with 1NC Block	☒ RCP2-BL42●			
PB Actuators-Illuminated Flush w/o Series Resistor		[HSN Code: 8536]		
Illuminated Actuator, Flush (With BA9 Filament Bulb) 12V, 24V, 48V, 110V AC / DC	RCP2-BW316▲○	270	10	
	RCP2-BW336▲●			
	RCP2-BW346▲●			
	RCP2-BW356▲●			
	RCP2-BW366▲●			
	RCP2-BW376▲○			
Illuminated Actuator, Flush (With BA9 Neon Bulb) 220V, 380V, 415V AC / DC	RCP2-BWN336▲●			
	RCP2-BWN346▲●			
	RCP2-BWN356▲●			
	RCP2-BWN356▲●			

Push Button Actuators - Illuminated Flush with Series Resistor		[HSN Code: 8536]						
Description	Reference	MRP (₹)	MOQ	Product Picture				
Illuminated Actuator, Flush (with BA9S Filament Bulb, 130V) 220V AC/DC	RCP2-BW317▲○	290	10					
	☒ RCP2-BW337▲●							
	☒ RCP2-BW347▲●							
	RCP2-BW357▲●							
	RCP2-BW367▲●							
	RCP2-BW377▲○							
	RCP2-BW387▲●							
LED Type Push Button Actuators - Illuminated Flush								
Flush Illuminated with Integral Circuit LED 48V, 24V & 12V (AC/DC) also available in 110V AC, 110V DC, 240V AC, 220DC	RCP2-BWL317▲○	340	10					
	RCP2-BWL337▲●							
	☒ RCP2-BWL347▲●							
	☒ RCP2-BWL357▲●							
	☒ RCP2-BWL377▲○							
	RCP2-BWL387▲●							
	RCP2-BWL367▲●				600			
Push Button Actuator-Illuminated Projecting without Series Resistor								
Illuminated Actuator, Flush (with BA9 filament bulb) 48V, 24V & 12V (AC/DC) also available in 110V AC, 110V DC, 240V AC, 220DC	RCP2-BW116▲○	260	10					
	RCP2-BW136▲●							
	RCP2-BW146▲●							
	RCP2-BW156▲●							
	RCP2-BW186▲●							
	RCP2-BW166▲●							
Illuminated Actuator, Flush (With BA9 Neon Bulb) 220V, 380V, 415V (AC/DC)	RCP2-BWN136▲●							
	RCP2-BWN146▲●							
	RCP2-BWN156▲●							
	RCP2-BWN186▲●	POR						
Push Button Actuator-Illuminated projecting without Series Resistor								
Illuminated Actuator, Projecting (with BA9S Filament Bulb, 130V) 220V (AC/DC)	RCP2-BW117▲○	270	10					
	RCP2-BW137▲●							
	RCP2-BW147▲●							
	RCP2-BW157▲●							
	RCP2-BW187▲●							
	RCP2-BW167▲●							
	RCP2-BW177▲○							
LED Type Push Button Actuators - Illuminated Projecting Type of voltage AC/DC to be specified								
Projecting Illuminated Actuator, with integral LED, suitable for operating 48V, 24V & 12V (AC/DC) also available in 110V AC, 110V DC, 240V AC, 220DC	RCP2-BWL117▲○	340	10					
	☒ RCP2-BWL137▲●							
	☒ RCP2-BWL147▲●							
	RCP2-BWL157▲●							
	RCP2-BWL177▲○							
	RCP2-BWL187▲●							
RCP2-BWL167▲●	610							
Colour Code for Actuator / Lens								
Colour Code	1	2	3	4	5	6	7	8
Colour of Actuator	White ○	Black ●	Green ●	Red ●	Yellow ●	Blue ●	-	-
Colour of Lens	White ○	-	Green ●	Red ●	Amber ●	Blue ●	Clear ○	Yellow ●

Push Buttons: 22.5mm
Without Contact Elements

GLOBAL CERTIFICATION



Selector Switch Actuators with Carrier		[HSN Code: 8536]		
Description	Reference	MRP (₹)	MOQ	Product Picture
2-Position Selector Switch (stay put)	RCP2-BD2	330	10	
3-Position Selector Switch, centre 'OFF' (stay put)	RCP2-BD3			
2-Position Selector Switch with extra long knob (stay put)	☒ RCP2-BJ2	330	10	
3-Position Selector Switch, with extra long knob centre 'OFF' (stay put)	RCP2-BJ3			
3-Position Selector Switch (Spring Return)	RCP2-BDR3	350	10	
3-Position Selector Switch extra long knob (Spring Return)	☒ RCP2-BJR3	350	10	
Selector Switch Actuators with Carrier & Contact Element				
2-Position Selector Switch (stay put) with 1NO Block	☒ RCP2-BD21	380	10	
2-Position Selector Switch, centre 'OFF' (stay put) with NO+NC Block	RCP2-BD25	460		
3-Position Selector Switch, centre 'OFF' (stay put) with NO+NC Block	RCP2-BD35			
Key Actuators with Carrier				
2-Position Key Switch, Key removable in unactuated position	☒ RCP2-BG2	470	10	
2-Position Key Switch, Key removable in both position	☒ RCP2-BG4			
2-Position Key Switch, Key removable in 'Right Hand' position	RCP2-BG02			
3-Position Key Switch, Key removable in centre 'OFF' position	☒ RCP2-BG3	480	10	
3-Position Key Switch, Key removable in all position	RCP2-BG0			
3-Position Key Switch, Key removable in 'Left Hand & Right Hand' position	RCP2-BG5			
3-Position Key Switch, Key removable in 'Left Hand' position	☒ RCP2-BG9			
3-Position Key Switch, Key removable in 'Right Hand' position	RCP2-BG7			
Push Buttons Extended Range				
Reset Extended Actuator Pushbutton - Round Type	☒ RCB2AL8R	110	24	
Reset Extended Actuator Pushbutton - Hex Type	☒ RCB2AL8H			
Plastic Adopter for 30 mm hole to 22.5 mm.	☒ RP2-BZ41M	35	30	
Metal Adopter for 30 mm hole to 22.5 mm	☒ RB2-BZ41M			
Recess (Guarded) Push button - Plastic	RP2-BA16 ○	95	20	
	RP2-BA26 ●			
	☒ RP2-BA36 ●			
	☒ RP2-BA46 ●			
	RP2-BA56 ●			
	RP2-BA66 ●			

Push Buttons Extended Range		[HSN Code: 8536]		
Description	Reference	MRP (₹)	MOQ	Product Picture
Intermittent Sounding Flashing Buzzer 15 ~ 20 mA, sound level 80 dB.24V, 48V, 110V AC/DC 240V AC (* Add Voltage code)	☒ RB2-KS* ●	360	15	
Pilot Lamps with Series Resistor				
Pilot Lamp (with BA9S Filament Bulb 130V) 220V AC / DC	RCP2-BV71 ▲○	240	10	
	RCP2-BV73 ▲●			
	RCP2-BV74 ▲●●			
	RCP2-BV75 ▲●●			
	RCP2-BV76 ▲●●			
	RCP2-BV77 ▲○			
Pilot Lamps with Series Resistor & Diode				
Pilot Lamp (with BA9S Filament Bulb 130V) 110V AC, 220V DC,	RCP2 BVD71 ▲○	260	10	
	RCP2-BVD73 ▲●			
	☒ RCP2-BVD74 ▲●●			
	☒ RCP2-BVD75 ▲●●			
	☒ RCP2-BVD76 ▲●●			
	RCP2-BVD77 ▲○			
LED Type Pilot Lamp Type of voltage AC / DC to be specified				
Pilot Light with integral circuit LED 48V, 24V & 12V (AC/DC) also available in 110V AC, 110V DC, 240V AC, 220DC	☒ RCP2-BVL73 ▲●●	310	10	
	☒ RCP2-BVL74 ▲●●			
	☒ RCP2-BVL75 ▲●●			
	RCP2-BVL77 ▲○			
	RCP2-BVL71 ▲○			
	☒ RCP2-BVL78 ▲●●			
	560			

How to Order:

Actuators, Contact Elements, Lens Assemblies can also be ordered separately or in combination, as required.

▲ Add Voltage Code

☒ Non Stockable item

NOTE: For contact elements NO/NC please refer page no. 96.



Push Buttons: 22.5mm

Metallic Range (Without Contact Elements)

GLOBAL CERTIFICATION



Push Button Actuators with Carrier-Non-Illuminated [HSN Code: 8536]				
Description	Reference	MRP (₹)	MOQ	Product Picture
Flush Spring Return Push Button	RCB2-BA1 ○	130		
	RCB2-BA2 ●			
	RCB2-BA3 ●			
	RCB2-BA4 ●			
	RCB2-BA5 ●			
	RCB2-BA6 ●			
Projecting Push Button	RCB2-BL1 ○	130	20	
	RCB2-BL2 ●			
	RCB2-BL3 ●			
	RCB2-BL4 ●			
	RCB2-BL5 ●			
	RCB2-BL6 ●			
Booted Push Button	RCB2-BP2 ●	190		
	RCB2-BP3 ●			
	RCB2-BP4 ●			
	RCB2-BP5 ●			
	RCB2-BP6 ●			
	RCB2-BP6 ●			
Mushroom Head Push Button, Spring Return	RCB2-BC2 ●	190	8	
	RCB2-BC3 ●			
	RCB2-BC4 ●			
	RCB2-BC5 ●			
Mushroom Head Push Button Stay Put (press to lock, turn to release)	RCB2-BS54 ●	270	8	
	RCB2-BS64 ●	340	5	
Mushroom Head Push Button, Push to Stay & Pull to release	RCB2-BT4 ●	300	8	
Mushroom Head Push Button, premarked Pull to Reset	RCB2-BT43 ●			
Mushroom Head Key Switch, StayPut, Key removable in both positions (press to lock and key to release)	RCB2-BS14 ●	530	8	
Push Button Stay Put (press to lock, turn to release)	RCB2-BS44 ●	260	10	
Push Button Actuators with Carrier & Contact Element-Non-Illuminated [HSN Code: 8536]				
Flush Spring Return Push Button with 1NO Block	RCB2-BA11 ○	230	10	
	RCB2-BA21 ●			
	RCB2-BA31 ●			
	RCB2-BA51 ●			
	RCB2-BA61 ●			
	RCB2-BA41 ●			
Push Button with 1NC Block	RCB2-BA42 ●			
Push Button with 2NO Block	RCB2-BA33 ●	320		
Projecting Head Push Button with 1NO Block	RCB2-BL11 ○	230	10	
	RCB2-BL21 ●			
	RCB2-BL31 ●			
	RCB2-BL51 ●			
Projecting PB with 1NC Block	RCB2-BL42 ●			
Mushroom Head Push Button Stay Put (press to lock, turn to release) with 1NC Block	RCB2-BS542 ●	360	8	
	RCB2-BS642 ●	430	4	
Mushroom Head Actuators - Illuminated [HSN Code: 8536]				
Mushroom head push button illuminated (with BA9S Filament Bulb, 130V) 220V AC/DC -2 Position Momentary	RCB2-BW437 ●	650	8	
	RCB2-BW447 ●			
	RCB2-BW637 ●	710		
	RCB2-BW647 ●			

Push Button Actuators-Illuminated Flush without Series Resistor [HSN Code: 8536]				
Description	Reference	MRP (₹)	MOQ	Product Picture
Illuminated Actuator, Flush (with BA9S Filament Bulb) 12V, 24V, 48V, 110V AC/DC	RCB2-BW316 ○	300	10	
	RCB2-BW336 ●			
	RCB2-BW346 ●			
	RCB2-BW356 ●			
	RCB2-BW366 ●			
	RCB2-BW376s ○			
Illuminated Actuator, Flush (with BA9S Neon Bulb) 220V, 380V, 415V AC/DC	RCB2-BWN336 ●	300		
	RCB2-BWN346 ●			
	RCB2-BWN356 ●			
Push Button Actuators-Illuminated Flush with Series Resistor				
Illuminated Actuator, Flush (with BA9S Filament Bulb, 130V) 220V AC/DC	RCB2-BW317 ○	320	10	
	RCB2-BW337 ●			
	RCB2-BW347 ●			
	RCB2-BW357 ●			
	RCB2-BW387 ●			
	RCB2-BW367 ●			
RCB2-BW377 ○				
LED Type Push Button Actuators - Illuminated Flush				
Flush Illuminated Actuator, with integral circuit LED 48V, 24V & 12V (AC/DC) also available in 110V AC, 110V DC, 240V AC, 220DC	RCB2-BWL337 ●	380	10	
	RCB2-BWL347 ●			
	RCB2-BWL357 ●			
	RCB2-BWL317 ○			
	RCB2-BWL377 ●			
	RCB2-BWL387 ●			
RCB2-BWL367 ●	630			
Push Button Actuators-Illuminated Projecting without Series Resistor				
Illuminated Actuator, Projecting (with BA9S Filament Bulb) 12V, 24V, 48V, 110V AC/DC	RCB2-BW116 ○	270	10	
	RCB2-BW136 ●			
	RCB2-BW146 ●			
	RCB2-BW156 ●			
	RCB2-BW166 ●			
	RCB2-BW176 ○			
Illuminated Actuator, Projecting (with BA9S Neon Bulb) 220V, 380V, 415V AC/DC	RCB2-BWN136 ●	270		
	RCB2-BWN146 ●			
	RCB2-BWN156 ●			
Push Button Actuators - Illuminated Projecting with Series Resistor				
Illuminated Actuator, Projecting (with BA9S Filament Bulb, 130V) 220VAC/DC	RCB2-BW117 ○	270	10	
	RCB2-BW137 ●			
	RCB2-BW147 ●			
	RCB2-BW157 ●			
	RCB2-BW167 ●			
	RCB2-BW177 ○			
	RCB2-BW177 ○			
LED Type Push Button Actuators - Illuminated Projecting Type of voltage AC/DC to be specified				
Projecting Illuminated Actuator, with integral circuit LED 48V, 24V & 12V (AC/DC) also available in 110V AC, 110V DC, 240V AC, 220DC	RCB2-BWL137 ●	380	10	
	RCB2-BWL147 ●			
	RCB2-BWL157 ●			
Projecting Illuminated Actuator, with integral circuit LED 48V, 24V & 12V (AC/DC) also available in 110V AC, 110V DC, 240V AC, 220DC	RCB2-BWL167 ●	720		
	RCB2-BWL167 ●			
Double Push Button Actuators - Illuminated Flush without Series Resistor				
Illuminated Double Push Button, Flush Green & Red Knob marked I&O respectively (with BA9S Neon Bulb) 220V, 380V, 415VAC/DC	RCB2-BWN96 ●	440	8	

* Stock for accessories are subject to availability ☒ Non Stockable item

MOQ-Minimum Order Quantity

Push Buttons: 22.5mm

Metallic Range (Without Contact Elements)

GLOBAL CERTIFICATION



Description	Reference	MRP (₹)	MOQ	Product Picture
Push Button Actuators with Carrier - Non-Illuminated [HSN Code: 8536]				
Double Push Button, Flush Green & Red Knob marked I&O respectively	RCB2-BA87	230	10	
Selector Switch Actuators with Carrier				
2-Position Selector Switch (stay put)	RCB2-BD2 RCB2-BD27*	370	10	
3-Position Selector Switch, centre 'OFF' (stay put)	RCB2-BD3 RCB2-BD37*			
2-Position Selector Switch with extra long knob (stay put)	RCB2-BJ2 <input checked="" type="checkbox"/> RCB2-BJ27*	380	10	
3-Position Selector Switch, with extra long knob centre 'OFF' (stay put)	RCB2-BJ3 <input checked="" type="checkbox"/> RCB2-BJ37*			
2-Position Selector Switch (Spring Return)	RCB2-BDR2 <input checked="" type="checkbox"/> RCB2-BDR27*	420	10	
3-Position Selector Switch (Spring Return)	RCB2-BDR3 RCB2-BDR37*			
2-Position Selector Switch extra long knob (Spring Return)	<input checked="" type="checkbox"/> RCB2-BJR2 RCB2-BJR27*	420	10	
3-Position Selector Switch extra long knob (Spring Return)	<input checked="" type="checkbox"/> RCB2-BJR3 RCB2-BJR37*			
Selector Switch Actuators with Carrier & Contact Element [HSN Code: 8536]				
2-Position Selector Switch (stay put) with 1NO Block	RCB2-BD21 <input checked="" type="checkbox"/> RCB2-BD271*	450	10	
2-Position Selector Switch, centre 'OFF' (stay put) with NO+NC Block	RCB2-BD25 <input checked="" type="checkbox"/> RCB2-BD275*	540		
3-Position Selector Switch, centre 'OFF' (stay put) with NO+NC Block	RCB2-BD35 <input checked="" type="checkbox"/> RCB2-BD375*			

*with Black Bezel

Selector Switch Actuators-Illuminated with Series Resistor [HSN Code: 8536]				
2-Position Illuminated Selector Switch (with BA9S Filament Bulb 130V) suitable for operation at 220V AC/DC	<input checked="" type="checkbox"/> RCB2-BK1237	590	10	
	<input checked="" type="checkbox"/> RCB2-BK1247			
	<input checked="" type="checkbox"/> RCB2-BK1257			
3-Position Illuminated Selector Switch (with BA9S Filament Bulb 130V) suitable for operation at 220V AC/DC	<input checked="" type="checkbox"/> RCB2-BK1337	590	10	
	<input checked="" type="checkbox"/> RCB2-BK1347			
	<input checked="" type="checkbox"/> RCB2-BK1357			

Selector Switch Actuators-Illuminated with integral circuit LED available on request

Selector Switch Actuators - Illuminated without series resistor				
3-Position Illuminated Selector Switch (with BA9S Filament Bulb) 48V, 24V & 12V (AC/DC) also available in 110V AC, 110V DC, 240V AC, 220DC	RCB2-BK1336	590	10	
	RCB2-BK1346			
	RCB2-BK1356			
2-Position Illuminated Selector Switch (with LED Bulb) 48V, 24V & 12V (AC/DC) also available in 110V AC, 110V DC, 240V AC, 220DC	<input checked="" type="checkbox"/> RCB2BKL1237	590	10	
	<input checked="" type="checkbox"/> RCB2BKL1247			
	<input checked="" type="checkbox"/> RCB2BKL1257			
3-Position Illuminated Selector Switch (with LED Bulb) 48V, 24V & 12V (AC/DC) also available in 110V AC, 110V DC, 240V AC, 220DC	<input checked="" type="checkbox"/> RCB2BKL1337	590	10	
	<input checked="" type="checkbox"/> RCB2BKL1347			
	<input checked="" type="checkbox"/> RCB2BKL1357			

* Stock for accessories are subject to availability. Non Stockable item

Description	Reference	MRP (₹)	MOQ	Product Picture
Key Actuators with Carrier [HSN Code: 8536]				
2-Position Key Switch, Key removable in unactuated position	RCB2-BG2 RCB2-BG27*	530	10	
2-Position Key Switch, Key removable in both position	RCB2-BG4 RCB2-BG47*			
2-Position Key Switch, Key removable in 'Right Hand' position	<input checked="" type="checkbox"/> RCB2-BG02 <input checked="" type="checkbox"/> RCB2-BG027*			
3-Position Key Switch, Key removable in centre 'OFF' position	RCB2-BG3 RCB2-BG37*	550	10	
3-Position Key Switch, Key removable in all position	<input checked="" type="checkbox"/> RCB2-BG0 RCB2-BG0-7*			
3-Position Key Switch, Key removable in 'Left Hand & Right Hand' position	<input checked="" type="checkbox"/> RCB2-BG5 RCB2-BG57*	550	10	
3-Position Key Switch, Key removable in 'Left Hand' position	RCB2-BG9 RCB2-BG97*			
3-Position Key Switch, Key removable in 'Right Hand' position	<input checked="" type="checkbox"/> RCB2-BG09 RCB2-BG097*			
3-Position (Spring Return) Key Switch, Key removable in 'Center' position	<input checked="" type="checkbox"/> RCB2-BG7 RCB2-BG77*			
Key Actuators with Carrier & Contact element				
2-Position Key Switch with 1NO Block, Key removable in unactuated position	<input checked="" type="checkbox"/> RCB2-BG21 RCB2-BG271*	580	10	
2-Position Key Switch with 1NO Block, Key removable in both position	<input checked="" type="checkbox"/> RCB2-BG41 RCB2-BG471*			
3-Position Key Switch with 1NO+1NC Block key removable in centre 'OFF' position	<input checked="" type="checkbox"/> RCB2-BG31 RCB2-BG371*	680	10	
3-Position Key Switch with 1NO+1NC Block key removable in all position	RCB2-BG04 RCB2-BG074*			

* with Black Bezel

Contact Elements - NO/NC (Non UL)* [HSN Code: 8536]				
Contact Element 1 NO	RE2BE101	90	50	
Contact Element 1 NC	RE2BE102			
Contact Elements - NO/NC (UL)*				
Contact Element 1 NO	RB2-BE-101	100	50	
Contact Element 1 NC	RB2-BE-102			

*Applicable for Both Metallic and Plastic range

How to Order:

Actuators, Contact Elements, Lens Assemblies can also be ordered separately or in combination, as required.

▲ Add Voltage Code

Colour Code for Actuator / Lens								
Colour Code	1	2	3	4	5	6	7	8
Colour of Actuator	White ○	Black ●	Green ●	Red ●	Yellow ●	Blue ●	-	-
Colour of Lens	White ○	-	Green ●	Red ●	Amber ●	Blue ●	Clear ○	Yellow ●

▲ Add Voltage Code

Pilot Lamps: 22.5mm
Metallic Range

Description	Reference	MRP (₹)	MOQ	Product Picture
LED Type Pilot Lamp-Type of voltage AC/DC [HSN Code: 8536]				
Pilot Light with integral circuit LED 48V, 24V & 12V (AC/DC) also available in 110V AC, 110V DC, 240V AC, 220DC	RCB2BVL71▲○	340	10	
	RCB2BVL73▲●	340		
	RCB2BVL74▲●			
	RCB2BVL75▲●			
	RCB-BVL77▲○			
	RCB2BVL78▲●			
	RCB2BVL76▲●			
Pilot Lamps with Series Resistor				
Pilot Lamp (with BA9S Filament bulb 130V) 220V AC/DC	RCB2-BV71▲○	250	10	
	RCB2-BV73▲●			
	RCB2-BV74▲●			
	RCB2-BV75▲●			
	RCB2-BV76▲●			
	RCB2-BV77▲○			
	RCB2-BV78▲●			
Pilot Lamps with Series Resistor & Diode				
Pilot Lamp (with BA9S Filament Bulb 130V) 240V AC	RCB2-BVD71▲○	270	10	
	RCB2-BVD73▲●			
	RCB2-BVD74▲●			
	RCB2-BVD75▲●			
	RCB2-BVD76▲●			
	RCB2-BVD77▲○			
	RCB2-BVD78▲●			

Description	Reference	MRP (₹)	MOQ	Product Picture
Economical Barrel LED Series - Type of voltage AC/DC [HSN Code: 8536]				
Suitable for operating at 12V DC, 240V AC, 415V AC AC/DC-24V, 110V, 220V	RCN7-IVL71▲○	350	20	
	RCN7-IVL76▲●			
	RCN7-IVL73▲●	190		
	RCN7-IVL74▲●			
	RCN7-IVL75▲●			
	RCN7-IVL77▲○			
	RCN7-IVL78▲●			

Description	Reference	MRP (₹)	MOQ	Product Picture
Push Button Powder Coated Actuators with Carrier [HSN Code: 8536]				
Flush Spring Return Push Button powder coated	RCB2-BA17○	130	20	
	RCB2-BA27●			
	RCB2-BA37●			
	RCB2-BA47●			
	RCB2-BA57●			
	RCB2-BA67●			
Projecting Push Button	RCB2-BL17○	140	15	
	RCB2-BL27●			
	RCB2-BL37●			
	RCB2-BL47●			
	RCB2-BL57●			
	RCB2-BL67●			
Integrated LED Pilot Lamp - Type of voltage AC/DC				
	RCB7-IVL71▲○	400	15	
	RCB7-IVL76▲●			
Integral LED pilot Lamp suitable for operating at common voltage (AC/DC) 110V, 48V, 24V & 12V Also available at operational voltage 240V AC, 220V DC, 110V AC, 110V DC	RCB7-IVL73▲●	230	15	
	RCB7-IVL74▲●			
	RCB7-IVL75▲●			
	RCB7-IVL77▲○			
	RCB7-IVL78▲●			
Wide range: 12V-240V (AC/DC)	RCB7-IVL71▲○	670	490	
	RCB7-IVL76▲●			
	RCB7-IVL73▲●			
	RCB7-IVL74▲●			
	RCB7-IVL75▲●			
	RCB7-IVL77▲○			

Colour Code for Actuator / Lens								
Colour Code	1	2	3	4	5	6	7	8
Colour of Actuator	White ○	Black ●	Green ●	Red ●	Yellow ●	Blue ●	-	-
Colour of Lens	White ○	-	Green ●	Red ●	Amber ●	Blue ●	Clear ○	Yellow ●

▲ Add Voltage Code

* Stock for accessories are subject to availability. MOQ- Minimum Order Quantity

















Accessories





Metallic Range (For Push Buttons & Pilot Lamps : 22.5mm)

GLOBAL CERTIFICATION



Operating Heads Without Contact Block and Carrier [HSN Code: 8536]				
Description	Reference	MRP (₹)	MOQ	Product Picture
Pilot Lamp Head	RB2-BV01 ○	130	20	
	RB2-BV03 ●			
	RB2-BV04 ●			
	RB2-BV05 ●			
	RB2-BV06 ●			
	RB2-BV07 ○			
	RB2-BV08 ●			
Flush Push Button	RB2-BA1 ○	110	20	
	RB2-BA2 ●			
	RB2-BA3 ●			
	RB2-BA4 ●			
	RB2-BA5 ●			
	RB2-BA6 ●			
Projecting Push Button	RB2-BL1 ○	130	20	
	RB2-BL2 ●			
	RB2-BL3 ●			
	RB2-BL4 ●			
	RB2-BL5 ●			
	RB2-BL6 ●			
Mushroom Spring Return	RB2-BC2 ●	180	8	
	RB2-BC3 ●			
	RB2-BC4 ●			
	RB2-BC5 ●			
Mushroom Stay Put	φ30mm RB2-BS44 ●	230	10	
	φ40mm RB2-BS54 ●	240	8	
	φ60mm RB2-BS64 ●	330	5	
Mushroom illuminated - 2 position Momentary - 2 position Maintained	RCB2-BW43 ●	410	8	
	RCB2-BW44 ●			
	RCB2-BW64 ●			
	RCB2-BW63 ●			
Booted Push Button	RB2-BP2 ●	190	20	
	RB2-BP3 ●			
	RB2-BP4 ●			
	RB2-BP5 ●			
	RB2-BP6 ●			
Double Headed without Light	RB2-BA87	230	10	
Double Headed Push Button with Light	RB2-BW9	250		
Illuminated Flush Push Button	RB2-BW31 ○	150	10	
	RB2-BW33 ●			
	RB2-BW34 ●			
	RB2-BW35 ●			
	RB2-BW36 ●			
	RB2-BW37 ○			
Illuminated Projecting Push Button	RB2-BW13 ●	160	10	
	RB2-BW14 ●			
	RB2-BW15 ●			
	RB2-BW16 ●			
	RB2-BW17 ○			
Illuminated Selector 2-Position Stay Put	RB2-BK123 ●	360	10	
	RB2-BK124 ●			
	RB2-BK125 ●			
Illuminated Selector 3-Position Stay Put	RB2-BK133 ●	380	10	
	RB2-BK134 ●			
	RB2-BK135 ●			

Operating Heads LED, Neon Pilot Lamp / Push Button Without Contact Block and Carrier [HSN Code: 8536]				
Description	Reference	MRP (₹)	MOQ	Product Picture
LED Pilot Lamp Head	RB2-BVL01 ○	110	20	
	RB2-BVL03 ●			
	RB2-BVL04 ●			
	RB2-BVL05 ●			
	RB2-BVL06 ●			
	RB2-BVL07 ○			
	RB2-BVL08 ●			
LED Illuminating Flush Push Button	RB2-BWL31 ○	160	10	
	RB2-BWL33 ●			
	RB2-BWL34 ●			
	RB2-BWL35 ●			
	RB2-BWL36 ●			
	RB2-BWL37 ○			
LED Illuminating Projecting Push Button	RB2-BWL11 ○	180	10	
	RB2-BWL13 ●			
	RB2-BWL14 ●			
	RB2-BWL15 ●			
	RB2-BWL16 ●			
	RB2-BWL17 ○			
RB2-BWL18 ●				

Operating Heads LED, Neon Pilot Lamp / Push Button Without Contact Block and Carrier [HSN Code: 8536]					
Description	Reference	Operating Handle	MRP (₹)	MOQ	Product Picture
Selector 2-Position, Stay Put	RB2-BD2	Standard	330	10	
Selector 2-Position, Stay Put	RB2-BJ2	Long	360		
Selector 2-Position, Spring Return	RB2-BDR2	Standard	330		
Selector 2-Position, Stay Put	RB2-BJR2	Long	360		
Selector 3-Position, Stay Put (Centre OFF)	RB2-BD3	Standard	330		
Selector 3-Position, Stay Put (Centre OFF)	RB2-BJ3	Long	360		
Selector 3-Position, Spring Return (Centre OFF)	RB2-BDR3	Standard	330		
Selector 3-Position, Stay Put	RB2-BJR3	Long	360		
Key Selector 2-Position, Stay Put	RB2-BG2	Key removable in L.H. position	490		
Key Selector 2-Position, Stay Put	RB2-BG4	Key removable in both positions	490		
Key Selector 2-Position, Stay Put	RB2-BG02	Key removable in R. H. position			
Key Selector 2-Position, Spring Return Stay Put	RB2-BG6	Key removable in L.H. position	490		
Key Selector 3-Position, Stay Put	RB2-BG3	Key removable in centre position			
Key Selector 3-Position, Stay Put	RB2-BG0	Key removable in all positions	490		
Key Selector 3-Position, Stay Put	RB2-BG5	Key removable in L. H. & R. H. position			
Key Selector 3-Position, Stay Put	RB2-BG9	Key removable in L. H. position	500		
Key Selector 3-Position, Stay Put	RB2-BG09	Key removable in R. H. position			
Key Selector 3-Position, Both Side Spring Return	RB2-BG7	Key removable in Centre position	500	8	
Mushroom Head with Key Stay Put	RB2-BS14 ●	Key removable in both positions			



Accessories

Metallic Range (For Push Buttons & Pilot Lamps : 22.5mm)

Body Assemblies with Contact Blocks, Screw & Captive Clamp Connection [HSN Code: 8536]					
Description	Reference	Contact Type	MRP (₹)	MOQ	Product Picture
For Actuators, Push Buttons, Selectors & Key Switches	RB2-BZ101	NO	160	20	
	RB2-BZ102	NC			
	RB2-BZ103	1NO+1NO	260	10	
	RB2-BZ104	1NC+1NC			
	RB2-BZ105	1NO+1NC			

Description	Reference	MRP (₹)	MOQ	Product Picture
Filament Bulb (BA9S) 130V, 48V, 24V, 12V & 6V (2.6W max.)	RL1-CF	50	100	
Neon Bulb (BA9S) 415V, 380V, 220V	RL1-CN			
Set of Lens (one inner and one outer) for Pilot Lamp Head	RB2-BV00*	30	20	
Lens for LED & Neon Type Pilot Lamp (w/o inner lens)	RB2-BVL00*			
Set of Lens (one inner and one outer) for Illuminating Actuator	RB2-BW00*			
Lens for Illuminating LED & Neon actuator (w/o inner lens)	RB2-BWL00*	30	100	
Silicon Cap suitable for, -Booted Push Button (coloured)	RB2BP00			
-Push Buttons Flush (Natural)	RC-S			
-Push Buttons Illuminated (Natural)	RCL	40		
Legend Plate with inscription (On, Off, Start, Stop, Slow, Fast, Forward, Reverse, Up, Down, Open, Close, Auto, Auto-o-Hand, Auto-Hand, Reset, Inch.)	RB2-BYN#	30	100	
Body / Carrier with mounting screws (passivated) for making different assemblies	RB2-B*	55	20	
Yellow legend (PVC) φ60mm	RB2-PY9330	70	50	
Emergency Stop φ90mm	RB2-PY8330	75	50	

#Minimum Order Qty. will be 500 Nos.

How to Order :

- Actuators, switch elements, lens assemblies can be ordered separately or in combination.
- Basic type designation for actuators is "RB2-B". Numerical colour code is added as a suffix to indicate the colour of the actuator or lens. Remove "*" and put numerical code as indicated below:

Colour Code	1	2	3	4	5	6	7	8
Colour of Actuator	White	Black	Green	Red	Yellow	Blue	-	-
Colour of Lens	White	-	Green	Red	Amber	Blue	Clear	Yellow

- Different suffixes are assigned for flush, projecting, selector actuators etc.
- The type designation for contact element is '1' for NO and '2' for NC.
- Basic type designation for legend plates is "RB2-BY". To complete code with type of inscription please remove "*" and put numerical code as indicated below.

Standard Text	Reference	Standard Text	Reference	MRP (₹)	MOQ
Start	2303	Stop	2304	30	250
Forward	2305	Reverse	2306		
Up	2307	Down	2308		
On	2311	Off	2312		
Open	2313	Close	2314		
Auto	2315	Hand	2316		
Reset	2323	Inch	2321		
Slow	2327	Fast	2328		
Auto - Hand	2364	Auto-O-Hand	2385		
		Hand-O-Auto	2387		

Important :

- Ordered quantities should be in multiple of standard packing.
- Illuminated Push Buttons & Pilot Lamps will be supplied with bulb only.
- N in product code stands for Neon Bulb.

☒ Non Stockable item. MOQ- Minimum Order Quantity

Control Stations (Assembled)

Complete Control Stations-Start & Stop Functions Plastic, Spring Return						
Description	Scheme	Colour	Making on legend	Reference	MRP (₹)	Product Picture
1 Flush Push Button	NO	3	I START	RC1P102	810	
				RC1P103		
1 Flush Push Button	NC	4	O STOP	RC1P112		
				RC1P114		
Latching Push Button	NC	4	STOP	RC1PBS542	870	
				RC1PYBS542		
Mushroom Head Key Switch	NC	4	STOP	RC1PBS142	1200	
				RC1PYBS142		
2 Flush Push Button	NO+NC	3	I	RC2P213	1160	
		4	O			
2 Flush Push Button	NO+NC	3	START	RC2P215		
		4	STOP			

Complete Control Stations Directional/Movement Control Functions Plastic, Spring Return [HSN Code: 8536]							
Description	Scheme	Colour	Marking on legend	Reference	MRP (₹)	Product Picture	
2 Flush Push Button	NO + NO	1	Up Down	RC2P222	1290		
				RC2P222A			
			Right Left	RC2P223			
				RC2P223A			
			Open Close	1			RC2P241
				2			Forward Reverse
3 Flush Push Button	NO + NC + NO	3 4 3	Forward Stop Reverse	RC3P311	1670		
				RC3P321			
			Right Stop Left	RC3P331			
				RC3P341			
			1 4 2	Up Down			RC3P324
							RC3P334

Control Stations for Customer Assembly Empty Enclosure, Plastic [HSN Code: 8536]							
Description	Top	Base	Number of Ways	Reference	MRP (₹)	Product Picture	
							Yellow
			1	RC - 1P			
Bone	Jet	Black	2	RC - 2P	720		
Grey			3	RC - 3P	820		
			4	RC - 4P	920		

- * Empty Enclosure's are available without contact blocks and push buttons and can be assembled with the accessories / spare parts as per specified requirements.
- * Stock for accessories are subject to availability



Control Stations (Assembled)

Complete Control Stations-Start and Stop Functions Metal, Spring Return [HSN Code: 8536]						
Description	Scheme	Colour	Marking on legend	Reference	MRP (₹)	Product Picture
1 Flush Push Button	NO	3	I START	RC 1M 102	1200	
				RC 1M 103		
1 Flush Push Button	NC	4	O STOP	RC 1M 112	1330	
				RC 1M 114		
Latching Push Button	NC	4	STOP	RC 1MBS542	1540	
Mushroom Head Key Switch	NC	4	STOP	RC 1MBS142	1540	
2 Flush Push Button	NO+NC	3	I O	RC 2M 213	1520	
				RC 2M 215		





Complete Control Stations Directional/ Movement Control Functions Metal, Spring Return [HSN Code: 8536]							
Description	Scheme	Colour	Marking on legend	Reference	MRP (₹)	Product Picture	
2 Flush Push Button	NO + NO	1 2	↑ ↓ Up-Down	RC 2M 222	1470		
				RC 2M 222A			
		1 2	↔ Right-Left	RC 2M 223			
				RC 2M 223A			
		1 2	Open-Close Forward-Reverse	RC 2M 241			
				RC 2M 222B			
3 Flush Push Button	NO + NC + NO	3 4 3	Forward Stop Reverse	RC 3M 311	1870		
				Up Stop Down			RC 3M 321
				Right Stop Left			RC 3M 331
				Open Stop Close			RC 3M 341
		1 2	↑ ↓ ↔ ↔	RC 3M 324			
RC 3M 334							





Control Stations for Customer Assembly Empty Enclosure, Metal [HSN Code: 8536]					
Description		Number of Ways	Reference	MRP (₹)	Product Picture
Top	Base				
Smoke Grey	Dark Grey	1	RC - 1M	930	
		2	RC - 2M	960	
		3	RC - 3M	1160	
		4	RC - 4M*	1410	

* Empty Enclosure's are available without contact blocks and push buttons and can be assembled with the accessories / spare parts as per specified requirements.

Operating Head for Control Stations

For Customer assembly

Plastic Operating Heads without Contact Block use with RC.P & RC.M enclosures - IP65 [HSN Code: 8536]				
Description	Reference	MRP (₹)	MOQ	Product Picture
Flush Push Button Spring Return	RP2-BA1 ○	110	20	
	RP2-BA2 ●			
	RP2-BA3 ●			
	RP2-BA4 ●			
	RP2-BA5 ●			
	RP2-BA6 ●			
Projecting Push Button	RP2-BL1 ○	110	20	
	RP2-BL2 ●			
	RP2-BL3 ●			
	RP2-BL4 ●			
	RP2-BL5 ●			
Mushroom Spring Return	RP2-BC2 ●	160	8	
	RP2-BC3 ●			
	RP2-BC4 ●			
	RP2-BC5 ●			
Mushroom Stay Put	RP2-BS44 ●	200	10	
	RP2-BS54 ●	220	8	
	RP2-BS64 ●	350	5	

Operating Heads for Control Stations Without Contact Block and Carrier [HSN Code: 8536]					
Description	Reference	Operating Handle	MRP (₹)	MOQ	Product Picture
Selector 2-Position, Stay Put	RP2-BD2	Standard	310	10	
Selector 3-Position, Stay Put (Centre OFF)	RP2-BD3	Standard			
Selector 3-Position, Spring Return (Centre OFF)	RP2-BDR3	Standard			
Key Selector 2-Position, Stay Put	RP2-BG2	Key removable in L.H. position	450	460	
Key Selector 2-Position, Stay Put	RP2-BG4	Key removable in both positions			
Key Selector 2-Position, Stay Put	RP2-BG02	Key removable in R. H. position			
Key Selector 3-Position, Stay Put	RP2-BG3	Key removable in centre position			
Key Selector 3-Position, Stay Put	RP2-BG0	Key removable in all positions			
Key Selector 3-Position, Stay Put	RP2-BG5	Key removable in L. H. & R. H. position	480	450	
Key Selector 3-Position, Stay Put	RP2-BG9	Key removable in L. H. position			
Key Selector 3-Position, Stay Put	RP2-BG09	Key removable in R. H. position			
Key Selector 3-Position, Both Side Spring Return	RP2-BG7	Key removable in Centreposition	450	8	
Mushroom Head with Key Stay Put	RP2-BS14	Key removable in both positions			

 Non Stockable item



GLOBAL CERTIFICATION



Operating Head for Control Stations

For Customer assembly

Metallic Operating Heads without Contact Block for RC.P & RC.M enclosures - IP65 [HSN Code: 8536]				
Description	Reference	MRP (₹)	MOQ	Product Picture
Flush Push Button Spring Return	RM2-BA1○	120	20	
	RM2-BA2●			
	RM2-BA3●			
	RM2-BA4●			
	RM2-BA5●			
	RM2-BA6●			
	RM2-BA334■			
Projecting Push Button	RM2-BL1○	120	20	
	RM2-BL2●			
	RM2-BL3●			
	RM2-BL4●			
	RM2-BL5●			
	RM2-BL6●			
Mushroom Spring Return ϕ 40mm	RM2-BC2●	180	8	
	RM2-BC3●			
	RM2-BC4●			
	RM2-BC5●			
	RM2-BC6●			
Mushroom Stay Put ϕ 30mm ϕ 40mm ϕ 60mm	RM2-BS44●	230	10	
	RM2-BS54●	260	8	
	RM2-BS64●	300	5	
Mushroom Push-Pull Type ϕ 40mm	RM2-BT43●	260	8	

Contact Blocks - Base Mounted For Control Stations Customer Assembly [HSN Code: 8536]					
Description	Reference	Contact Type	MRP (₹)	MOQ	Product Picture
Contact Block	RB2BE-101BM/P*	NO	110	50	
Slow Break	RB2BE-102BM/P*	NC			

* Please specify 'M' if required for Metallic and 'P' if required for Plastic.

Legends (Stickers) are supplied with the following Standard Texts, Plastic [HSN Code: 8536]					
Description	Reference	Standard Text	Reference	MRP (₹)	MOQ
Start	RP2-BY2303	Stop	RP2-BY2304	15	100
Forward	RP2-BY2305	Reverse	RP2-BY2306		
Up	RP2-BY2307	Down	RP2-BY2308		
On	RP2-BY2311	Off	RP2-BY2312		
Open	RP2-BY2313	Close	RP2-BY2314		
Auto	RP2-BY2315	Hand	RP2-BY2316		
Reset	RP2-BY2323	Inch	RP2-BY2321		
Slow	RP2-BY2327	Fast	RP2-BY2328		
Power On	RP2-BY2326	Emer. Stop	RP2-BY2330		
Right	RP2-BY2309	Left	RP2-BY2310		
O	RP2-BY2146	--	RP2-BY2147		
→	RP2-BY1912	←	RP2-BY1913		
↑	RP2-BY1914	↑	RP2-BY1915		

Note: Minimum order of #10 each.

Operating Heads for Control Stations Without Contact Block and Carrier [HSN Code: 8536]					
Description	Reference	Operating Handle	MRP (₹)	MOQ	Product Picture
Selector 2-Position, Stay Put	RM2-BD2	Standard	330	10	
Selector 2-Position, Spring Return	RM2-BDR2	Standard			
Selector 3-Position, Stay Put (Centre OFF)	RM2-BD3	Standard			
Selector 3-Position, Spring Return (Centre OFF)	RM2-BDR3	Standard			
Key Selector 2-Position, Stay Put	RM2-BG2	Key removable in L.H. position	450	10	
Key Selector 2-Position, Stay Put	RM2-BG4	Key removable in both positions	480		
Key Selector 2-Position, Stay Put	RM2-BG02	Key removable in R. H. position			
Key Selector 2-Position, Spring Return Stay Put	RM2-BG6	Key removable in L.H. position			
Key Selector 3-Position, Stay Put	RM2-BG3	Key removable in centre position	500		
Key Selector 3-Position, Stay Put	RM2-BG0	Key removable in all positions			
Key Selector 3-Position, Stay Put	RM2-BG5	Key removable in L.H. & R.H. position	500		
Key Selector 3-Position, Stay Put	RM2-BG9	Key removable in L.H. position	540		
Key Selector 3-Position, Stay Put	RM2-BG09	Key removable in R. H. position			
Key Selector 3-Position, Both Side Spring Return	RM2-BG7	Key removable in Centre position			
Mushroom Head with Key Stay Put	RM2-BS14I	Key removable in both positions	480	8	

Legends (Stickers) are supplied with the following standard texts, Metal [HSN Code: 8536]					
Description	Reference	Standard Text	Reference	MRP (₹)	MOQ
Start	RM2-BY2303	Stop	RM2-BY2304	15	100
Forward	RM2-BY2305	Reverse	RM2-BY2306		
Up	RM2-BY2307	Down	RM2-BY2308		
On	RM2-BY2311	Off	RM2-BY2312		
Open	RM2-BY2313	Close	RM2-BY2314		
Auto	RM2-BY2315	Hand	RM2-BY2316		
Reset	RM2-BY2323	Inch	RM2-BY2321		
Slow	RM2-BY2327	Fast	RM2-BY2328		
Power On	RM2-BY2326	Emer. Stop	RM2-BY2330		
Right	RM2-BY2309	Left	RM2-BY2310		
O	RM2-BY2146	--	RM2-BY2147		
→	RM2-BY1912	←	RM2-BY1913		
↑	RM2-BY1914	↑	RM2-BY1915		

Note: Minimum order of #10 each.

MOQ- Minimum Order Quantity

Motor Starters



Features

- Conforms to IS 13947-4-1
- 3Ø DOL Starter range: 0.50HP~60HP
- 3Ø Reversing DOL Starter range: 0.5HP~20HP
- 3Ø Star Delta Starter range: 7.5HP~350HP

Custom built Starter solutions with incomer MCCB & Electronic Motor Protection Relay

- 3Ø Intelligent Star Delta Starter range: 40HP~ 350HP
- 3Ø Intelligent Auto Transformer Starter range: 40HP~ 350HP



Motor Starters

Conforming IS/IEC60947-4-1

Star Delta Starter with TC1DXEA Contactor & LR1D Relay in S.S. Enclosure					[HSN Code: 8536]
Std. Power Rating for 3Ph. Motor at 415V		Reference	Relay LR1D Range Amps	MRP (₹)	MOQ
HP	kW				
3	2.2	BE3DXEAP163■307	1.6-2.5	17500	6
3	2.2	BE3DXEAP163■308	2.5-4.0	17500	
5	3.7	BE3DXEAP163■310	4.0-6.0	17500	
7.5	5.6	BE3DXEAP163■312	5.5-8.0	17500	
10	7.5	BE3DXEAP163■314	7.0-10.0	17500	
12.5	9.3	BE3DXEAP163■316	10.0-13.0	17500	
12.5	9.3	BE3DXEAP163■316X	9.0-14.0	17500	
15	11.2	BE3DXEAP203■321	13.0-18.0	19790	
20	15	BE3DXEAP253■321X	14.0-22.0	19790	
25	18.6	BE3DXEAP253■322	18.0-25.0	19790	



DOL Starter with TC1DXEA Contactor & LR1D Relay in S.S. Enclosure					[HSN Code: 8536]
Std. Power Rating for 3Ph. Motor at 415V		Reference	Relay LR1D Range Amps	MRP (₹)	MOQ
HP	kW				
0.5	0.37	BE1DXEAP163■305	0.63-1.0	4860	2
0.75	0.55	BE1DXEAP163■306	1.0-1.6	4860	
1.5	1.1	BE1DXEAP163■307	1.6-2.5	4860	
2	1.5	BE1DXEAP163■308	2.5-4.0	4860	
3	2.2	BE1DXEAP163■310	4.0-6.0	4860	
5	3.7	BE1DXEAP163■312	5.5-8.0	4860	
5.5	4	BE1DXEAP163■314	7.0-10.0	4860	
7.5	5.5	BE1DXEAP163■316	10.0-13.0	4860	
7.5	5.5	BE1DXEAP163■316X	9.0-14.0	4860	
12	9	BE1DXEAP203■321	13.0-18.0	5500	
12	9	BE1DXEAP253■321X	14.0-22.0	5500	
15	11	BE1DXEAP253■322	18.0-25.0	5500	
20	15	BE1DXEAP403■353	23.0-32.0	8320	
20	15	BE1DXEAP403■355	28.0-40.0	8320	

Coil voltage code for Exceed DOL & Star Delta starter			
Motor Starter	Voltage		
BE1DXEAP/BE3DXEAP	220	190-400	250-450

Industrial Starters are available in the above wide band operating range Standard coil voltages.

Motor Starters

Conforming IS/IEC60947-4-1



Std. Power Rating for 3Ph. Motor at 415V				Reference	Relay LR1D Range Amps	MRP (₹)	MOQ
HP	kW						
1.5	1.1			BE1-DXP204#307	1.6-2.5	POR	6
2.0	1.5			BE1-DXP204#308	2.5-4.0		
3	2.2			BE1-DXP204#310	4.0-6.0		
5	3.7			BE1-DXP204#312	5.5-8.0		
5.5	4.0			BE1-DXP204#314	7-10		
7.5	5.5			BE1-DXP204#316X	9-14		
12	9			BE1-DXP204#321	13-18		
15	11			BE1-DXP254#321XH	14-22		
				BE1-DXP254#322	18-25		
25	18			BE1-DXP404#353	23-32		

Std. Power Rating for 3Ph. Motor at 415V				Reference	Relay LR1D Range Amps	MRP (₹)	MOQ
HP	kW						
7.5	5.5			BE3-DXP204#312	5.5-8.0	18990	2
12	9			BE3-DXP204#314	7.0-10	18990	
15	11			BE3-DXP204#316X	9-14	18990	
20	15			BE3-DXP204#321	13-18	19230	
				BE3-DXP254#321XH	14-22	21600	
25	18			BE3-DXP254#322	18-25	21600	
30	22			BE3-DXP254#353	23-32	24830	



Industrial Starter	Voltage		
BE1-DXP	220	190-400#	250-450#
BE3-DXP	-	190-400#	250-450#
Coil Code	M	Q	N

Industrial Starters are available in the above wide band operating range Standard coil voltages.



Std. Power Rating for 3Ph. Motor at 415V		Reference	Relay Range Amps	MRP (₹)	MOQ
HP	kW				
0.5	0.37	LE1-D173#305	0.63-1.00	4030	1
0.75	0.55	LE1-D173#306	1.0-1.60	4030	
1.5	1.1	LE1-D173#307	1.60-2.50	4030	
2	1.5	LE1-D173#308	2.50 ~ 4.00	4030	
3	2.2	LE1-D173#310	4.00 ~ 6.00	4030	
5	3.7	LE1-D173#312	5.50 ~ 8.00	4030	
7.5	5.5	LE1-D173#316X	9.0 ~ 14.0	4030	
12	9	LE1-D253#321	13.0 ~ 18.0	8280	
15	11	LE1-D253#322	18.0 ~ 25.0	8280	



Motor Starters
Conforming IS/IEC60947-4-1



DOL Starter with D range Contactor & LR1D OLR in S.S. Enclosure			[HSN Code: 8536]		
Std. Power Rating for 3Ph. Motor at 415V		Reference	Relay Range Amps	MRP (₹)	MOQ
HP	kW				
0.5	0.37	BE1-D1735■305	0.63-1.00	4770	1
0.75	0.55	BE1-D1735■306	1.0-1.60		
1.5	1.1	BE1-D1735■307	1.60-2.50		
2	1.50	BE1-D1735■308	2.50-4.0		
3	2.2	BE1-D1735■310	4.00-6.00		
5	3.7	BE1-D1735■312	5.50-8.00		
7.5	5.5	BE1-D1735■316X	9.0-14.0		
12	9	BE1-D2535■321	13.0-18.0	9900	
15	11	BE1-D2535■322	18.0-25.0		
20	15	BE1-D3235■353	23.0-32.0	16400	
30	22	BE1-D4035■355	28.0-40.0	24020	
35	25	BE1-D5035■357	38.0-50.0	26790	
40	30	BE1-D6335■359	48.0-57.0	31200	



Reversing Starter with D range Contactor & LR1D OLR in S.S. Enclosure			[HSN Code: 8536]		
Std. Power Rating for 3Ph. Motor at 415V		Reference	Relay Range Amps	MRP (₹)	MOQ
HP	kW				
0.5	0.37	BE2-D1735■305	0.63-1.00	14710	1
0.75	0.55	BE2-D1735■306	1.0-1.60		
1.5	1.1	BE2-D1735■307	1.60-2.50		
2.0	1.5	BE2-D1735■308	2.50-4.00		
3.0	2.2	BE2-D1735■310	4.00-6.00		
5.0	3.7	BE2-D1735■312	5.50-8.00		
5.5	4.0	BE2-D1735■314	7.00-10.0		
7.5	5.5	BE2-D1735■316X	9.0-14.0	18200	
12.0	9.0	BE2-D2535■321	13.0-18.0		
15.0	11.0	BE2-D2535■322	18.0-25.0	20450	
20.0	15.0	BE2-D3235■353	23.0-32.0	30160	



Automatic Star Delta Starter with D range Contactor & robusta (F Range), LR1D OLR & Electronic Star Delta Timer			[HSN Code: 8536]			
Std. Power Rating for 3Ph. Motor at 415V		Reference	Relay Range Amps	MRP (₹)	MOQ	
kW	HP					
3	4	BE3-D1735■308	2.5-4.0	17470		
4	5.5	BE3-D1735■310	4.0-6.0			
5.5	7.5	BE3-D1735■312	5.5 - 8.0			
9	12	BE3-D1735■314	7.0 ~ 10.0			
11	15	BE3-D1735■316X	9.0 ~ 14.0			
15	20	BE3-D2235■321	13.0 ~ 18.0	18150		
18	25	BE3-D2535■322	18.0 - 25.0	24600		
22	30	BE3-D3235■322	18.0 - 25.0	41000		
25	35	BE3-D3235■353	23.0 - 32.0			
30	40	BE3-D4035■355	30.0 - 40.0	49350		
37	50	BE3-D5035■355	30.0 - 40.0	65820	1	
51	70	BE3-D6335■359	48.0 - 57.0	108550		
59	80	BE3-D8035N 361	57.0 - 66.0			
75	100	BE3-F115 363	66.0 - 80.0	133440		
90	125	BE3-F115N105	65.0 ~ 105.0	158660		
110	150	BE3-F150N125	80.0 ~ 125.0	163650		
132	180	☒BE3-F185N160	100.0-160.0	261210		
160	220	☒BE3-F185N200	125.0-200.0			
200	270	☒BE3-F265N250	160.0-250.0	285690		
220	300	☒BE3-F330N315	200.0-315.0	296100		
260	350	☒BE3-F330S315	200.0-315.0			

☒ Non Stockable item

Motor Starters

Conforming IS/IEC60947-4-1

Semi-Automatic Star Delta Starter with D range Contactor, LR1D OLR					
Std. Power Rating for 3 Ph. Motor at 415V		Reference	Relay Range Amps	MRP (₹)	MOQ
kW	HP				
3	4	BE3-D1735■308SA	2.5 ~ 4	12540	1
4	5.5	BE3-D1735■310SA	4 ~ 6		
5.5	7.5	BE3-D1735■312SA	5.5 ~ 8		
9	12	BE3-D1735■314SA	7 ~ 10		
11	15	BE3-D1735■316XSA	9 ~ 14		
15	20	BE3-D2535■321SA	13 ~ 18	17280	
18	25	BE3-D2535■322SA	18 ~ 25		

Coil Voltage Codes (Standard) for DOL Starters with D range Contactor		
Motor Starter	Voltage	
BE1-D/LE1-D	220V	415V
Coil Code	UW	N

** DOL Motor Starter are available only in the above Standard Coil Voltages.

Coil Voltage Codes (Standard) for DOL & Star Delta Starters with D range Contactor		
Motor Starter	Voltage	
BE1-D / BE2-D / BE3-D / BE3-F	380#	415
Coil Code	NW	N

Wide Band Coil available for Star Delta Starters upto 40HP only.

How to order Industrial Starter:

- Complete the code by replacing the blue square (■) by the letter(s) corresponding to the Coil Voltage selected.
- Industrial DOL Starters should be selected based on the FLC of Pump/Motor & Coil Voltage required.

How to order Star Delta Starter:

- Complete the code by replacing the blue square (■) by the letter(s) corresponding to the Coil Voltage selected.
- Star Delta starters should be selected based on the FLC of the Pump/Motor phase current (Motor FLC X 0.58) & Coil Voltage required.

Custom Built Motor Starters Solutions

■ Smart Start Delta Starter rating 40 HP to 150 HP 3 Phase 415V AC

- Incomer 3 Pole MCCB, 10-25kA
- Selection of liberal D range, air break Contactor
Electronic motor protection relay with built-in feature having pause of 0.30 sec for motor protection against single phasing
- Electronic Star Delta Timer
- Housed in free standing IP 54 sheet steel enclosure with bottom cable entry
- Optional facility: Water Level Controller also available

■ Intelligenet Star Delta Starter rating 40 HP to 350 HP 3 Phase 415V AC

- Incomer 3 Pole MCCB, 10-25kA
- Selection of liberal D range, air break Contactor
- Digital motor protection Relay type mPro100 with 7 segment display to assure complete motor protection against overload, phase loss, under current, unbalance, motor stall, earth fault, locked rotor
- Electronic Star Delta Timer
- Housed in free standing IP 54 sheet steel enclosure with bottom cable entry

■ Intelligent Auto Transformer Starter rating 40 HP to 350 HP 3 Phase 415V AC (closed transition)

- Incomer 3 Pole MCCB, 10-25kA
- Selection of liberal D range, air break Contactor
- Digital motor protection Relay type mPro100 with 7 segment display to assure complete motor protection against overload, phase loss, under current, unbalance, motor stall, earth fault, lock rotor
- Auto Transformer, air cooled, 6 starts/hours with built-in thermister having tapping at 50%, 60% & 80% of the rated voltage
- Electronic Timer for changeover function
- Housed in free standing IP 54 sheet steel enclosure with bottom cable entry

MOQ- Minimum Order Quantity

CS1 Series Starters

CS1 Series Starters (DOL & Star-Delta) are available with contactors type CS1, CS2 & CS3 having 16A, 25A, 32A AC3 duty. These Starters are specially designed for agricultural use and have following features:

- Conforms to IEC 60947-4-1
- Wide band coil
- Rugged design which is durable and easy for maintenance
- Spares are available across the country
- Elegant powder coated sheet metal box made from 0.8 mm CRCA sheet



3Ø DOL Starters in SS Enclosure [HSN Code: 8536] GST@18%

Reference	Relay Range (Amp)	Max. Motor Output at 415V, 3 Ph		MRP (₹)	Std. Pkg. (Nos.)
		kW	HP		
CS1DO■1525NR	1.5-2.5	0.75	1	2830	1
CS1DO■2504NR	2.5-4	1.5	2		
CS1DO■0406NR	4-6.5	3	4		
CS1DO■0610NR	6-10	4.5	6		
CS1DO■0914NR	9-14	5.5	7.5		
CS1DO■1118NR	11-18	5.5	7.5	2880	
CS1DO■1322NR	13-22	5.5	7.5	2940	
CS2DO■1322NR	13-22	5.5	7.5	3150	
CS2DO■2032NR	20-32	5.5	7.5	3240	
CS3DO■2032NR	20-32	5.5	7.5	3370	



3Ø Fully Automatic Star-Delta starters in SS Enclosure [HSN Code: 8536] GST@18%

Reference	Relay Range (Amp)	Max. Motor Output at 415V, 3Ph		MRP (₹)	Std. Pkg. (Nos.)
		KW	HP		
CS1SD■0610NR	6-10	7.5	10	10310	1
CS1SD■0914NR	9-14	9.3	12.5		
CS1SD■1118NR	11-18	11	15		
CS1SD■1322NR	13-22	11	15		
CS2SD■1322NR	13-22	11	15		
CS2SD■2032NR	20-32	11	15		
CS3SD■2032NR	20-32	16	22	11130	



3Ø DOL in S.S. Enclosure [HSN Code: 8536] GST@18%

Incorporating Heavy Duty 4 Pole Contactor type TC1-DX with wide band operating coil, Overload relay type LR3D with manual re-set and yellow flag for trip indication

Reference	Relay Range (Amp)	Standard Power Rating		MRP (₹)	Std. Pkg. (Nos.)
		kW	HP		
BE1-DXM204■307NR	1.6-2.5	0.75	1	4370	6
BE1-DXM204■308NR	2.5-4	1.1/1.5	1.5/2		
BE1-DXM204■310NR	4-6	2.2	3		
BE1-DXM204■312NR	5.5-8	2.2	3		
BE1-DXM204■314NR	7-10	3.7	5		
BE1-DXM204■316XNR	9-14	3.7/4	5/5.5		
BE1-DXM204■321NR	13-18	5.5	7.5	4670	
BE1-DXM254■321XNR	14-22	7.5	10	4900	
BE1-DXM254■322NR	18-25	10	12	5070	
BE1-DXM404■353NR	23-32	11	15	7000	



Motor Starters

Conforming IS/IEC60947-4-1



3Ø Automatic Star Delta Starter in S.S Enclosure [HSN Code: 8536] GST@18%
 Incorporating Heavy Duty 4 Pole Contactor type TC1-DX with wide band operating coil, Overload relay type LR3D for motor protection & Electronic Star Delta Timer

Reference	Relay Range (Amp)	Std. Power Rating for 3P at 415V		MRP (₹)	Std. Pkg. (Nos.)
		kW	HP		
BE3-DXM204■308NR	2.5-4	1.5	2	14270	2
BE3-DXM204■310NR	4-6	2.2	3		
BE3-DXM204■312NR	5.5-8	3.7	5		
BE3-DXM204■314NR	7-10	5.5	7.5		
BE3-DXM204■316XNR	9-14	9	12		
BE3-DXM204■321NR	13-18	11	15	14710	
BE3-DXM254■321XNR	14-22	11	15	16840	
BE3-DXM254■322NR	18-25	11	15		
BE3-DXM254■353NR	23-32	15/18	20/25		



3Ø Semi Automatic Star Delta Starter in S.S Enclosure [HSN Code: 8536] GST@18%
 Incorporating Heavy Duty 4 Pole Contactor type TC1-DX with wide band operating coil, Overload relay type LR3D for motor protection

Reference	Relay Range (Amp)	Std. Power Rating for 3P at 415V		MRP (₹)	Std. Pkg. (Nos.)
		kW	HP		
BE3-DXM204■314SANR	7-10	9	12	11850	2
BE3-DXM204■316XSANR	9-14	11	15		
BE3-DXM204■321SANR	13-18	15	20	12230	
BE3-DXM254■321XSANR	14-22	18	25	15170	
BE3-DXM254■322SANR	18-25	18	25		
BE3-DXM254■353SANR	23-32	22.5	30		



3Ø Submersible Pump Starter Automatic Star Delta in S.S. Enclosure [HSN Code: 8536] GST@18%
 Incorporating Heavy Duty 4 Pole contactor type TC1-DX with wide band operating coil, Overload relay type LR1D with pneumatic timer

Reference	Relay (Amp)	Standard Power Rating		MRP (₹)	Std. Pkg. (Nos.)
		kW	HP		
BE3-DXM204■307-PTNR	1.6-2.5	1.5	2	14330	1
BE3-DXM204■308-PTNR	2.5-4	3	4		
BE3-DXM204■310-PTNR	4-6	4	5.5		
BE3-DXM204■312-PTNR	5.5-8	5.5	7.5		
BE3-DXM204■316X-PTNR	9-14	11	15		
BE3-DXM204■321-PTNR	13-18	15	20	14790	
BE3-DXM254■321X-PTNR	14-22	18	25	16960	
BE3-DXM254■322-PTNR	18-25	18	25		
BE3-DXM254■353-PTNR	23-32	22.5	30		

Coil Voltage Codes (Standard) for DOL / Star Delta Starters

Coil Voltage (AC) 50Hz	Voltage	
		190-400 Q

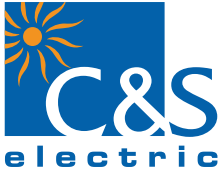

Protection Measurement & Control Devices



- Digital Panel Meters
- Multi Function Meters
- Power Factor Controller
- Power Quality Measurements
- Demand Controller
- Electronic Motor Protection Relay
- Electronic Motor Protection Relay-CSMP
- Earth Leakage Relay
- DG AMF / Synchronizing Controller
- Voltage & Current Monitoring Relay & Timer



Protection, Measurement & Control Devices

Digital Panel Meters

Features

- SMPS Auxiliary supply (35-300 VAC/DC)
- True RMS measurement
- High glow display for distant viewing
- Programmable CT & PT Ratio
- Programmable 1A/5A site selectable
- Accuracy class 1.0 / 0.5
- Auto / Manual display scroll
- Auto scaling of decimal Point



Description	Display	Reference	HSN Code	MRP (₹)
Single Phase Volt Meter 18-520V	1 Row, 4 Digit	CSM-AT-1-V	85364900	1460
Three Phase Volt Meter 10-300V (L-N), 18-520V (LL)	1 Row, 4 Digit	CSM-AT-3-V	85364900	2060
Three Phase Volt Meter 10-300V (L-N), 18-520V (LL)	3 Row, 4 Digit	CSM-AT-3-V3	85364900	2560
Single Phase Ampere Meter 50mA TO 6.0 A AC	1 Row, 4 Digit	CSM-AT-1-I	85364900	1460
Three Phase Ampere Meter 50mA TO 6.0 A AC	1 Row, 4 Digit	CSM-AT-3-I	85364900	2060
Three Phase Ampere Meter 50mA TO 6.0 A AC	3 Row, 4 Digit	CSM-AT-3-I3	85364900	2560

Multi Function Meters

Features

- SMPS Auxiliary supply (35-300 VAC/DC), True RMS measurement
- High glow display for distant viewing, Programmable CT & PT Ratio
- Programmable 1A/5A site selectable, Accuracy class 1.0 / 0.5, Auto / Manual display scroll
- Auto scaling of decimal Point, Optional RS-485 Modbus Communication



Description	Display	Reference	HSN Code	MRP (₹)
Single Phase VIF Meter VLN, I, F	1 Row, 4 Digit	CSM-AT-1-VIF	85364900	3200
Three Phase VIF Meter VLN, VLL, I1,I2,I3, F	3 Row, 4 Digit	CSM-AT-3-VIF	85364900	3400
Digital Frequency Meter 40-70 Hz	1 Row, 4 Digit	CSM-AT-F	85364900	1460
Digital RPM Meter 1500 RPM at 50 Hz	1 Row, 4 Digit	CSM-AT-FR	85364900	POR
Digital Hour Meter	1 Row, 4 Digit	CSM-AT-R	85364900	1560
DC Voltmeter 0-200 V	1 Row, 4 Digit	CSM-AT-MDC-V-200	85364900	POR
DC Ampere Meter 75 mV Shunt	1 Row, 4 Digit	CSM-AT-MDC-I-2000	85364900	
DC Ampere Meter 75 mV Shunt,	1 Row, 4 Digit	CSM-AT-MDC-I-10000	85364900	
Digital RPM Meter 1500 RPM at 10 VDC Or 3000 RPM at 10 VDC	1 Row, 4 Digit	CSM-AT-RPM	85364900	

Power Factor Controller

Features

- 6/8/12 Conventional (Contactor switching) Power Factor Controller
- Protection & Indication of abnormal condition such as over/under compensation, over Voltage, over/under Current etc.
- Wide range of CT ratio & Target PF Selection
- Automatic C/K Setup Mode.
- Indication of Active bank through LED's
- Selection of various wiring scheme



Description	Reference	HSN Code	MRP (₹)
Single CT Input Controller (LED based)			
6 Stage APFC Controller with Single CT Input	CSPF-100-R06-110	85381010	12230
8 Stage APFC Controller with Single CT Input	CSPF-100-R08-110	85381010	14480
12 Stage APFC Controller with Single CT Input	CSPF-100-R12-110	85381010	16540
Single CT Input Controller (LCD based)			
6 Stage APFC Controller with Single CT Input	CSPF-200-R06-220	85381010	16300
8 Stage APFC Controller with Single CT Input	CSPF-200-R08-220	85381010	17870
12 Stage APFC Controller with Single CT Input	CSPF-200-R12-220	85381010	19550



Protection, Measurement & Control Devices

Electronic Motor Protection Relay

Models

mPRO200, mPRO100, mPRO90, mPRO 50

Protection

Overload/ Phase loss/ Locked rotor/ Stall/ Phase reversal/ Current unbalance/ Short circuit/ Under current/ Earthfault (Residual / CBCT) Over temperature, external fault

Features

- Din mount Base & Door mount LCD Display
- High Accurate Compact Multi Protection LV Protection Relay
- Trip Class Selection from 5 to 60
- Can be use in Inverter Circuit (20~200Hz)
- Last 5 fault records / Motor Run hour
- Option Modbus on RS485 or 4~20 mA analog output
- Last 3 START / STOP record
- DI / DO Matrix programmability
- Multiple Reset functions



mPRO200

Description	Reference	Current Range (A)	HSN Code	MRP (₹)
MPRO-200, Rated current range (5-60A), with internal residual calculation, Aux supply (190-260V AC)	MPRO-200-60-E-00-H-V2	5.0-60	85364900	18830
MPRO-200, Rated current range (1-5A), with internal residual calculation, Aux supply (190-260V AC)	MPRO-200-05-E-00-H-V2	1.0-5.0	85364900	18830
MPRO-200, Rated current range (5-60A), with internal residual calculation, Aux supply (100-160V AC)	MPRO-200-60-E-00-L-V2	5.0-60	85364900	18830
MPRO-200, Rated current range (1-5A), with internal residual calculation, Aux supply (100-160V AC)	MPRO-200-05-E-00-L-V2	1.0-5.0	85364900	18830
MPRO-200, Rated current range (1-5A), with internal residual calculation, 4-20mA output + DI, Aux supply (190-260V AC)	MPRO-200-05-E-A0-H-V2	1.0-5.0	85364900	23540
MPRO-200, Rated current range (1-5A), with internal residual calculation, 4-20mA output + DI, Aux supply (100-160V AC)	MPRO-200-05-E-A0-L-V2	1.0-5.0	85364900	23540
MPRO-200, Rated current range (1-5A), with internal residual calculation, MODBUS RS485+DI, Aux supply (190-260V AC)	MPRO-200-05-E-C0-H-V2	1.0-5.0	85364900	23540
MPRO-200, Rated current range (1-5A), with internal residual calculation, MODBUS RS485+DI, Aux supply (100-160V AC)	MPRO-200-05-E-C0-L-V2	1.0-5.0	85364900	23540
MPRO-200, Rated current range (1-5A), with external CBCT Circular ID=57mm, Plastic casing, Aux Supply (190-260V AC)	MPRO-200-05-Z55-00-H-V2	1.0-5.0	85364900	24720
MPRO-200, Rated current range (1-5A), with external CBCT Circular ID=57mm, Plastic casing, Aux Supply (100-160V AC)	MPRO-200-05-Z55-00-L-V2	1.0-5.0	85364900	24720
MPRO-200, Rated current range (1-5A), with external CBCT Circular ID=57mm, Plastic casing, 4-20mA output + DI, Aux Supply (190-260V AC)	MPRO-200-05-Z55-A0-L-C1-V2	1.0-5.0	85364900	47080
MPRO-200, Rated current range (1-5A), with external CBCT Circular ID=57mm, Plastic casing, 4-20mA output + DI, Aux Supply (100-160V AC)	MPRO-200-05-Z55-A0-L-V2	1.0-5.0	85364900	34130
MPRO-200, Rated current range (1-5A), with external CBCT Circular ID=57mm, Plastic casing, 4-20mA output + DI, Aux Supply (190-260V AC)	MPRO-200-05-Z55-A0-H-V2	1.0-5.0	85364900	34130
MPRO-200, Rated current range (1-5A), with external CBCT Circular ID=57mm, Plastic casing, MODBUS RS485 + DI, Aux Supply (100-160V AC)	MPRO-200-05-Z55-C0-L-V2	1.0-5.0	85364900	34130
MPRO-200, Rated current range (5-60A), with internal residual calculation, 4-20mA output + DI, Aux supply (100-160V AC)	MPRO-200-60-E-A0-L-V2	5.0-60	85364900	23540
MPRO-200, Rated current range (5-60A), with internal residual calculation, 4-20mA output + DI, Aux supply (190-260V AC)	MPRO-200-60-E-A0-H-V2	5.0-60	85364900	23540
MPRO-200, Rated current range (5-60A), with internal residual calculation or external CBCT (field selectable), Aux Supply (85-300V AC/DC)	MPRO-200-60-EZ-00-W-V2	5.0-60	85364900	47080
MPRO-200, Rated current range (5-60A), with internal residual calculation or external CBCT (field selectable), MODBUS RS485, Aux Supply (85-300V AC/DC)	MPRO-200-60-EZ-R0-W-V2	5.0-60	85364900	47080
MPRO-200, Rated current range (5-60A), with internal residual calculation, MODBUS RS485 + DI, Aux supply (190-260V AC)	MPRO-200-60-E-C0-H-V2	5.0-60	85364900	23540
MPRO-200, Rated current range (5-60A), with external CBCT Circular ID=57mm, Plastic casing, 4-20mA output + DI, Aux supply (100-160V AC)	MPRO-200-60-Z55-A0-L-C1-V2	5.0-60	85364900	47080
MPRO-200, Rated current range (5-60A), with external CBCT Circular ID=57mm Plastic casing, 4-20mA + DI, Aux supply (100-160V AC)	MPRO-200-60-Z55-A0-L-V2	5.0-60	85364900	34130
MPRO-200, Rated current range (5-60A), with external CBCT Circular ID=57mm Plastic casing, 4-20mA + DI, Aux supply (190-260V AC)	MPRO-200-60-Z55-A0-H-V2	5.0-60	85364900	34130
MPRO-200, Rated current range (5-60A), with external CBCT Circular ID=57mm Plastic casing, Aux supply (190-260V AC)	MPRO-200-60-Z55-00-H-V2	5.0-60	85364900	24720
MPRO-200, Rated current range (5-60A), with external CBCT Circular ID=57mm Plastic casing, Aux supply (100-160V AC)	MPRO-200-60-Z55-00-L-V2	5.0-60	85364900	24720
MPRO-200, Rated current range (1-5A), with external CBCT Circular ID=92mm, Plastic casing, Aux Supply (190-260V AC)	MPRO-200-05-Z90-00-H-V2	1.0-5.0	85364900	30020
MPRO-200, Rated current range (1-5A), with external CBCT Circular ID=57mm Plastic casing, MODBUS RS485 + DI, Aux Supply (190-260V AC)	MPRO-200-05-Z55-C0-H-V2	1.0-5.0	85364900	34130



mPRO100



mPRO90

Description	Reference	Current Range (A)	HSN Code	MRP (₹)
MPRO-100, Rated current range (1-5A), with internal residual calculation, Aux Supply (190-260V AC)	MPRO-100-5-E-H-V2	1.0-5.0	85364900	17070
MPRO-100, Rated current range (1-5A), with internal residual calculation, Aux Supply (100-160V AC)	MPRO-100-5-E-L-V2	1.0-5.0	85364900	17070
MPRO-100, Rated current range (5-60A), with internal residual calculation, Aux Supply (190-260V AC)	MPRO-100-60-E-H-V2	5.0-60	85364900	17070
MPRO-100, Rated current range (5-60A), with internal residual calculation, Aux Supply (100-160V AC)	MPRO-100-60-E-L-V2	5.0-60	85364900	17070
MPRO-100, Rated current range (1-5A), with external CBCT circular, ID=57mm, plastic casing, Aux Supply (100-160V AC)	MPRO-100-5-Z55-L-V2	1.0-5.0	85364900	23540
MPRO-100, Rated current range (1-5A), with external CBCT circular, ID=70mm, plastic casing, Aux Supply (100-160V AC)	MPRO-100-5-Z70-L-V2	1.0-5.0	85364900	28840
MPRO-100, Rated current range (1-5A), with external CBCT circular, ID=92mm, plastic casing, Aux Supply (100-160V AC)	MPRO-100-5-Z90-L-V2	1.0-5.0	85364900	28840
MPRO-100, Rated current range (1-5A), with external CBCT circular, ID=120mm, plastic casing, Aux Supply (100-160V AC)	MPRO-100-5-Z120-L-V2	1.0-5.0	85364900	27070
MPRO-100, Rated current range (5-60A), with external CBCT circular, ID=57mm, plastic casing, Aux supply (100-160V AC)	MPRO-100-60-Z55-L-V2	5.0-60	85364900	23540
MPRO-100, Rated current range (5-60A), with external CBCT circular, ID=70mm, plastic casing, Aux supply (100-160V AC)	MPRO-100-60-Z70-L-V2	5.0-60	85364900	24720
MPRO-100, Rated current range (5-60A), with external CBCT circular, ID=92mm, plastic casing, Aux supply (100-160V AC)	MPRO-100-60-Z90-L-V2	5.0-60	85364900	25890
MPRO-100, Rated current range (5-60A), with external CBCT circular, ID=120mm, plastic casing, Aux supply (100-160V AC)	MPRO-100-60-Z120-L-V2	5.0-60	85364900	27070
MPRO-100, Rated current range (1-5A), with external CBCT circular, ID=57mm, plastic casing, Aux Supply (190-260V AC)	MPRO-100-5-Z55-H-V2	1.0-5.0	85364900	23540
MPRO-100, Rated current range (1-5A), with external CBCT Circular ID=70mm, Plastic casing, Aux Supply (190-260V AC)	MPRO-100-5-Z70-H-V2	1.0-5.0	85364900	24720
MPRO-100, Rated current range (1-5A), with external CBCT circular, ID=92 mm, plastic casing, Aux Supply (190-260V AC)	MPRO-100-5-Z90-H-V2	1.0-5.0	85364900	25890
MPRO-100, Rated current range (1-5A), with external CBCT Circular ID=120mm, Plastic casing, Aux Supply (190-260V AC)	MPRO-100-5-Z120-H-V2	1.0-5.0	85364900	27070
MPRO-90, External CT1 Rated current Range (0.2-10A), with internal residual calculation	MPRO-90-CT1-E	0.2-10	85364900	10360
MPRO-90, External CT2 Rated current Range (0.8-25A), with internal residual calculation	MPRO-90-CT2-E	0.8-25	85364900	10360
MPRO-90, External CT3 Rated current Range (2-62.5A), with internal residual calculation	MPRO-90-CT3-E	2.0-62.5	85364900	10950
MPRO-90, External CT4 Rated current Range (4-125A), with internal residual calculation	MPRO-90-CT4-E	4.0-125	85364900	12950
MPRO-90, External CT5 Rated current Range (8-250A), with internal residual calculation	MPRO-90-CT5-E	8.0-250	85364900	16480
MPRO-90, External CT1 Rated current Range (0.2-10A), with internal residual calculation, Star-Delta	MPRO-90-CT1-E-SDT	0.2-10	85364900	21780
MPRO-90, External CT2 Rated current Range (0.8-25A), with internal residual calculation, Star-Delta	MPRO-90-CT2-E-SDT	0.8-25	85364900	21780
MPRO-90, External CT3 Rated current Range (2-62.5A), with internal residual calculation, Star-Delta	MPRO-90-CT3-E-SDT	2.0-62.5	85364900	22360
MPRO-90, External CT4 Rated current Range (4-125A), with internal residual calculation, star-Delta	MPRO-90-CT4-E-SDT	4.0-125	85364900	24720
MPRO-90, External CT5 Rated current Range (8-250A), with internal residual calculation, Star-Delta	MPRO-90-CT5-E-SDT	8.0-250	85364900	28250



Protection, Measurement & Control Devices



Accessories			
Description	Reference	HSN Code	MRP (₹)
Current Transformer Ratio 100/5A, Burden 5VA, Cl.1.0	3-CT-100/5	85043100	4870
Current Transformer Ratio 200/5A, Burden 5VA, Cl.1.0	3-CT-200/5	85043100	4870
Current Transformer Ratio 300/5A, Burden 5VA, Cl.1.0	3-CT-300/5	85043100	6070
Current Transformer Ratio 400/5A, Burden 5VA, Cl.1.0	3-CT-400/5	85043100	6070
Current Transformer Ratio 500/5A, Burden 5VA, Cl.1.0	3-CT-500/5	85043100	8590
Current Transformer Ratio 600/5A, Burden 5VA, Cl.1.0	3-CT-600/5	85043100	8590

ORDERING INFORMATION



- Protection Model Series**
- External CT Selection**
 - CT1 : Rated current Range (0.2-10A)
 - CT2 : Rated current Range (0.8-25.0A)
 - CT3 : Rated current Range (2.0-62.5A)
 - CT4 : Rated current Range (4.0-125A)
 - CT5 : Rated current Range (8.0-250A)
- Earth Fault**
 - E : with Internal Residual Calculation
- Options**
 - O : Basic version
 - SDT : with In-built STAR-DELTA control

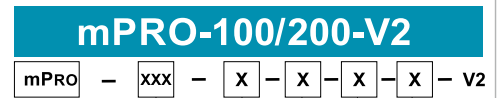

- Protection Model Series**
 - 100 : with In-built LED display
 - 200 : with Extended LCD display
- Rated Current**
 - 60 : Rated current Range (5-60A)
 - 5 : Rated current Range (1-5A)
- Earth Fault**
 - E : with Internal Residual Calculation
 - Z55 : with external CBCT - Circular, ID 57 mm (CBCT 55), Plastic casing
 - Z70 : with external CBCT - Circular, ID 70 mm (CBCT 70), Plastic casing
 - Z90 : with external CBCT - Circular, ID 92 mm (CBCT 90), Plastic casing
 - Z120 : with external CBCT - Circular, ID 120 mm (CBCT120), Plastic casing
- Options**
 - 00 : NONE
 - A0 : 4-20 mA Output + Digital Input
 - OT : PTC thermistor + Digital Input
 - C0 : MODBUS RS485 + Digital Input
 - AT : 4-20 mA Output + PTC thermistor + Digital Input
 - CT : MODBUS RS485 + PTC thermistor + Digital Input
- Auxiliary Supply**
 - L : 110V AC (100-160V AC)
 - H : 220V AC (190-260V AC)

* CBCT Ordering Information (To be selected for mPRO-200-x-Z-x-x model)

CBCT SIZE
Z55 : Circular, ID 57 mm (CBCT 55), Plastic casing
Z70 : Circular, ID 70 mm (CBCT 70), Plastic casing
Z90 : Circular, ID 92 mm (CBCT 90), Plastic casing
Z120 : Circular, ID 120 mm (CBCT 120), Plastic casing

Electronic Motor Protection Relay - CSMP

Protection

Overload/ Phase loss/ Locked rotor/ Phase reversal/ Current unbalance/ Short circuit/ Under current/ Earthfault

Features

- Detachable Din mount Base & Door mount LED Display
- High Accurate Compact Multi Protection LV Protection Relay
- Trip Class Selection from 5 to 60
- Display of 3 phase RMS Current, % current unbalance
- Looping option is available for FHP motors
- Fault diagnostic by LED indication



Description	Reference	Current Range (A)	HSN Code	MRP (₹)
Relay CSMPA-80-3SR,80A,100-260VAC	CSMPA-80-3SR,80A,100-260VAC	16-80	85364900	16850
Relay CSMPA-40-3SR,40A,100-260VAC	CSMPA-40-3SR,40A,100-260VAC	8.0-40	85364900	15730
Relay CSMPA-40-3SR,20A,100-260VAC	CSMPA-40-3SR,20A,100-260VAC	4.0-20	85364900	15730
Relay CSMPA-22-3SR,22A,100-260VAC	CSMPA-22-3SR,22A,100-260VAC	4.4-22	85364900	15730
Relay CSMPA-22-3SR,5A,100-260VAC	CSMPA-22-3SR,5A,100-260VAC	1.0-5	85364900	15730
Relay CSMPA-22-3SR,1.5A,100-260VAC	CSMPA-22-3SR,1.5A,100-260VAC	0.3-1.5	85364900	15730
Relay CSMPM-06i-S (2a+1b) AC/DC85-260V 50/60Hz	CSMPM-06i-S(2A+1B)AC/DC85-260V 50/60HZ	0.5-6.0	85364900	30330
Relay CSMPM-06i-SE (2a+1b) AC/DC85-260V 50/60Hz	CSMPM-06i-SE(2A+1B)AC/DC85-260V 50/60HZ	0.5-6.0	85364900	35950
Relay CSMPM-06i-SI (2a+1b) AC/DC85-260V 50/60Hz	CSMPM-06i-SI(2A+1B)AC/DC85-260V 50/60HZ	0.5-6.0	85364900	30330
Relay CSMPM-06i-SM (2a+1b) AC/DC85-60V 50/60Hz	CSMPM-06i-SM(2A+1B)AC/DC85-60V 50/60HZ	0.5-6.0	85364900	35950
Relay CSMPM-06i-SZ (2a+1b) AC/DC85-260V 50/60Hz	CSMPM-06i-SZ(2A+1B)AC/DC85-260V 50/60HZ	0.5-6.0	85364900	30330
Relay CSMPM-06i-SZIA (2a+1b) AC/DC85-260V 50/60Hz	CSMPM-06i-SZIA(2A+1B)AC/DC85-260V50/60HZ	0.5-6.0	85364900	44940
Relay CSMPM-65i-S (2a+1b) AC/DC85-260V 50/60Hz	CSMPM-65i-S(2A+1B)AC/DC85-260V 50/60HZ	5.0-65	85364900	30330
Relay CSMPM-65i-SE (2a+1b) AC/DC85-260V 50/60Hz	CSMPM-65i-SE(2A+1B)AC/DC85-260V 50/60HZ	5.0-65	85364900	35950
Relay CSMPM-65i-SI (2a+1b) AC/DC85-260V 50/60Hz	CSMPM-65i-SI(2A+1B)AC/DC85-260V 50/60HZ	5.0-65	85364900	30330
Relay CSMPM-65i-SM (2a+1b) AC/DC85-260V 50/60Hz	CSMPM-65i-SM(2A+1B)AC/DC85-260V 50/60HZ	5.0-65	85364900	35950
Relay CSMPM-65i-SZ (2a+1b) AC/DC85-260V 50/60Hz	CSMPM-65i-SZ(2A+1B)AC/DC85-260V 50/60HZ	5.0-65	85364900	30330
IMC-IIIIM4852MAC110V50/60Hz	IMC-III-M485-2-MAC110V50/60Hz	6 / 60	85364900	83710
Relay IMP-CNOAC/DC85-245V	IMP-C-NO AC/DC85-245V	10 / 100	85364900	41570
Relay IMP-CA420AC/DC85-245V	IMP-C-A420 AC/DC85-245V	10 / 100	85364900	47750
Relay IMP-C-M485-AC/DC 85-245-40/60	IMP-C-M485-AC/DC 85-245-40/60	10 / 100	85364900	47750
Relay CSMPA-60-T,6A,220VAC	CSMPA-60-T,6A,220VAC	0.5-6.0	85364900	6570
Relay CSMPA-60-T,60A,220VAC	CSMPA-60-T,60A,220VAC	5.0-60	85364900	6570
Relay CSMPA-60-T,60A,110VAC	CSMPA-60-T,60A,110VAC	s5.0-60	85364900	6570
Relay CSMPA-60-T,6A,110VAC	CSMPA-60-T,6A,110VAC	0.5-6.0	85364900	6570
Relay CSMPA-60-T,60A,415VAC	CSMPA-60-T,60A,415VAC	5.0-60	85364900	6570
Relay CSMPA-60-T,6A,415VAC	CSMPA-60-T,6A,415VAC	0.5-60	85364900	6570

Accessories

Description	Reference	HSN Code	MRP (₹)
Display Cable-1-1.15 m	ASSY.,(1-1.5)CSMPM	85381090	3600
Display Cable-4 m	ASSY.,(4M)CSMPM	85381090	3940
Z-CTD with ID=30mm	Z-CTD30	85043100	4770
Z-CTD with ID=50mm	Z-CTD50	85043100	5390
Z-CTD with ID=65mm	Z-CTD65	85043100	5960
Z-CTD with ID=80mm	Z-CTD80	85043100	6520

ELR - Earth Leakage Relay

Models

ELR 1.0, ELR 3.0



ELR 1.0



ELR 3.0

Protection & Features

- Monitors, Detects & Protects Power system from Earth Leakage Fault
- Wide range of Selectable Earth Leakage Current Setting
- Configurable Earth Leakage Trip time 0-30s
- LED indication for Earth Leakage Fault & Alarm indication
- Trip Circuit Failure Indication
- Last 10 Fault records with date & time
- CBCT measures the leakage current to the highest accuracy
- Flush / DIN Rail mountable based on model selection

Description	Reference		HSN Code	MRP (₹)
Earth Leakage Relay ELR1.0 protection series, LED display with panel front mounting, current range (30mA-3A), Aux Supply (85-280V AC / 95-280V DC), CBCT Type Circular, ID 120 mm with plastic casing	ELR1.0-S-03-W-C120	30mA~3A	85364900	7310
Earth Leakage Relay ELR1.0 protection series, LED display with panel front mounting, current range (30mA-3A), Aux Supply (85-280V AC / 95-280V DC), CBCT Type Circular, ID 150 mm Resin Cast	ELR1.0-S-03-W-C150	30mA~3A	85364900	11240
Earth Leakage Relay ELR1.0 protection series, LED display with panel front mounting, current range (30mA-3A), Aux Supply (85-280V AC / 95-280V DC), CBCT Type Circular, ID 200 mm Resin cast	ELR1.0-S-03-W-C200	30mA~3A	85364900	14050
Earth Leakage Relay ELR1.0 protection series, LED display with panel front mounting, current range (30mA-3A), Aux Supply (85-280V AC / 95-280V DC), CBCT Type Circular, ID 57 mm with plastic casing	ELR-1.0-S-03-W-C55	30mA~3A	85364900	5620
Earth Leakage Relay ELR1.0 protection series, LED display with panel front mounting, current range (30mA-3A), Aux Supply (85-280V AC / 95-280V DC), CBCT Type Circular, ID 70 mm with plastic casing	ELR-1.0-S-03-W-C70	30mA~3A	85364900	6180
Earth Leakage Relay ELR1.0 protection series, LED display with panel front mounting, current range (30mA-3A), Aux Supply (85-280V AC / 95-280V DC), CBCT Type Circular, ID 92 mm with plastic casing	ELR-1.0-S-03-W-C90	30mA~3A	85364900	6180
Earth Leakage Relay ELR1.0 protection series, LED display with front panel mounting Current Range (30mA-3A), Aux Supply (85-280V AC/95-280V DC), CBCT Rectangular type ID 300 x 80 (CCT 300) Resin cast	ELR1.0-S-03-W-R300	30mA~3A	85364900	16850
Earth Leakage Relay ELR1.0 protection series, LED display with panel front mounting, current range (300mA-12A), Aux Supply (85-280V AC / 95-280V DC), CBCT Type Circular, ID 92 mm with plastic casing	ELR-1.0-S-12-W-C120	30mA~3A	85364900	7310
Earth Leakage Relay ELR1.0 protection series, LED display with panel front mounting, current range (300mA-12A), Aux Supply (85-280V AC / 95-280V DC), CBCT Type Circular, ID 120 mm with plastic casing	ELR-1.0-S-12-W-C90	30mA~3A	85364900	6180
Earth Leakage Relay ELR3.0 protection series, LCD display with panel front mounting, current range (300mA-12A), Aux Supply (85-280V AC / 95-280V DC), CBCT Type Circular, ID 120 mm with plastic casing	ELR-3.0-L-03-W-C120	30mA~3A	85364900	14050



Protection, Measurement & Control Devices

DG AMF / Synchronizing Controller

Models

EC2, EGA-250, EC-RXA, CD 2.0, CD 5.0

Protection & Features

- Display 3 Phase Mains Parameters: Voltage & Frequency
- Display of 3 Phase Generator Parameters: Voltage, Frequency, Speed, Run Hours
- Multi-genset Synchronizer & Load Share Unit
- Fault record with date & time stamp
- Event record with date & time stamp
- ATS/ATF/ Remote Start Controller/ Engine Controller



Description	Reference	HSN Code	MRP (₹)
Relay EC2(VER1.10)	EC2(VER1.10)	85364900	23590
Relay EC-RXA_V2	EC-RXA_V2	85364900	14330
Relay EGA-250-0	EGA-250-0	85364900	16850
Relay EC2(VER 2.10)	EC2-V2.10	85364900	23590
AMF Relay CD2.0 with MPU	AMF RELAY CD2.0 WITH MPU	85364900	18540
AMF Relay CD 5.0	AMF Relay CD 5.0	85364900	50560
Relay DG Synchronizer Relay CD5.0 with RS485/Ethernet	DG SYNC RELAY CD5.0 RS485/ETHERNET	85364900	169650
Relay EGC-250-0	EGC-250-0	85364900	17980

Voltage & Current Monitoring Relay & Timer

Model

Voltage Monitoring, Current Monitoring & Timers

Protection & features

- 3 Phase Voltage Monitoring
- 1 Phase Current Monitoring
- ON / OFF Delay Timer



Description	Reference	HSN Code	MRP (₹)
ENYA series- Multifunction Timer,Up to 7 functions,7 time ranges,Wide input voltage range	E1Z1E1024-240VAC/DC VE10 (110204A)	85364900	8660
Monitoring relays - ENYA series, Voltage monitoring in 3- and 1-phase mains	E1YM400VS10 (1340405H)	85364900	5340
Monitoring relays - GAMMA series, AC/DC current monitoring in 1-phase mains	G2IM10AL20,24-240V (2390410)	85364900	26960
ENYA series-Multifunction Timer,Up to 7 functions,7 time ranges,Wide input voltage range	E1ZM10 12-240VAC/DC	85364900	8990
Monitoring relays - ENYA series, Tripping unit for temperature monitoring	E3TF01 230VAC	85364900	14610
Monitoring relays - ENYA series - AC/DC current monitoring in 1-phase mains	E3IM10AL20,230VAC (1341200)	85364900	22690
ENYA series, Timers - Multifunction,Up to 7 functions,7 time ranges,Wide input voltage range	E1ZMQ10,24-240VAC/DC	85364900	8990
ENYA series- Timers - Asymmetric flasher	E1ZI10 12-240VAC/DC	85364900	8990
Monitoring relays - GAMMA series,Voltage monitoring in 3-phase mains	G2PM690VSY20	85364900	28090
Monitoring relays - GAMMA series, Voltage monitoring in 3-phase mains	G2PM400VSY20(2390504)	85364900	20790
Monitoring relays - GAMMA series,a.c./d.c. current monitoring in 1-phase mains	G2IM5AL20,24-240V	85364900	26960
Monitoring relays - GAMMA series, a.c./d.c. current monitoring in 1-phase mains	G2IM10AL20 24-240V AC/DC	85364900	26960
Monitoring Relays-TR Series	TR2-400VAC(282117)	85364900	2700



Final Power Distribution Components



Miniature Circuit Breakers ■ Residual Current Circuit Breakers
Isolators ■ MCB Type Changeover Switches ■ ACCL ■ Distribution Boards
Cable End Boxes ■ Plugs & Socket DBs ■ MCB Enclosures

WiNtrip2 Miniature Circuit Breaker

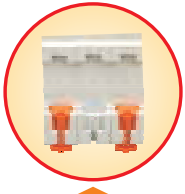

Two stage easy snapping device for Din Rail Mounting

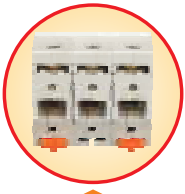

Bi-connect terminals for Cable and Busbar

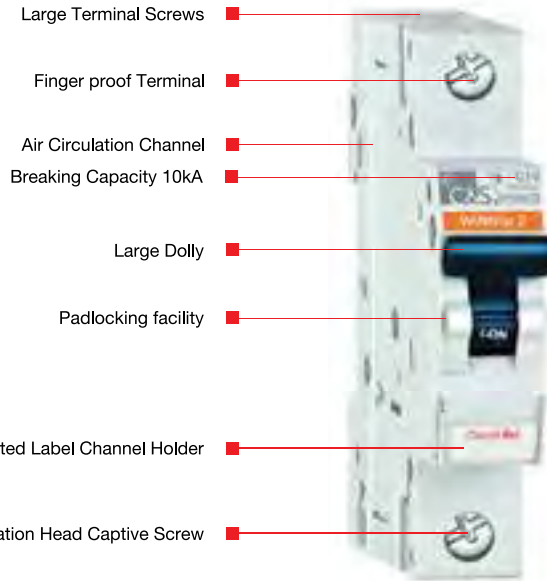

B-Series

Lighting & Distribution with no Surge Current

[HSN Code: 8536]



Current rating (Amps.)	Product Code	MRP (₹)	Std. Pkg. (Nos.)
1 Pole			
6	CSMBS1B6	280	12
10	CSMBS1B10	280	
16	CSMBS1B16	280	
20	CSMBS1B20	280	
25	CSMBS1B25	280	
32	CSMBS1B32	280	
40	CSMBS1B40	650	
50	CSMBS1B50	730	
63	CSMBS1B63	730	

Current rating (Amps.)	Product Code	MRP (₹)	Std. Pkg. (Nos.)
3 Pole			
6	CSMBS3B6	1510	4
10	CSMBS3B10	1510	
16	CSMBS3B16	1510	
20	CSMBS3B20	1510	
25	CSMBS3B25	1510	
32	CSMBS3B32	1510	
40	CSMBS3B40	2250	
50	CSMBS3B50	2250	
63	CSMBS3B63	2250	



Current rating (Amps.)	Product Code	MRP (₹)	Std. Pkg. (Nos.)
1 Pole + N			
6	CSMBS1B6N	910	6
10	CSMBS1B10N	910	
16	CSMBS1B16N	910	
20	CSMBS1B20N	910	
25	CSMBS1B25N	910	
32	CSMBS1B32N	910	
40	CSMBS1B40N	1320	
50	CSMBS1B50N	1490	
63	CSMBS1B63N	1490	

Current rating (Amps.)	Product Code	MRP (₹)	Std. Pkg. (Nos.)
3 Pole + N			
6	CSMBS3B6N	1980	3
10	CSMBS3B10N	1980	
16	CSMBS3B16N	1980	
20	CSMBS3B20N	1980	
25	CSMBS3B25N	1980	
32	CSMBS3B32N	1980	
40	CSMBS3B40N	2640	
50	CSMBS3B50N	2930	
63	CSMBS3B63N	2930	



Current rating (Amps.)	Product Code	MRP (₹)	Std. Pkg. (Nos.)
2 Pole			
6	CSMBS2B6	1010	6
10	CSMBS2B10	1010	
16	CSMBS2B16	1010	
20	CSMBS2B20	1010	
25	CSMBS2B25	1010	
32	CSMBS2B32	1010	
40	CSMBS2B40	1430	
50	CSMBS2B50	1650	
63	CSMBS2B63	1650	

Current rating (Amps.)	Product Code	MRP (₹)	Std. Pkg. (Nos.)
4 Pole			
6	CSMBS4B6	2190	3
10	CSMBS4B10	2190	
16	CSMBS4B16	2190	
20	CSMBS4B20	2190	
25	CSMBS4B25	2190	
32	CSMBS4B32	2190	
40	CSMBS4B40	2860	
50	CSMBS4B50	3050	
63	CSMBS4B63	3050	

CSMBS1B50, CSMBS3B50, CSMBS1B50N, CSMBS3B50N, CSMBS2B50, CSMBS4B50: Non Stockable item



WiNtrip2 Miniature Circuit Breaker

C-Series

Inductive load with surge current - Motor Circuit Applications

[HSN Code: 8536]



Current rating (Amps.)	Product Code	MRP (₹)	Std. Pkg. (Nos.)
1 Pole			
0.5	CSMBS1C0.5	490	12
1	CSMBS1C1	490	
2	CSMBS1C2	490	
3	CSMBS1C3	490	
4	CSMBS1C4	490	
5	CSMBS1C5	490	
6	CSMBS1C6	290	
10	CSMBS1C10	290	
16	CSMBS1C 16	290	
20	CSMBS1C20	290	
25	CSMBS1C25	290	
32	CSMBS1C32	290	
40	CSMBS1C40	690	
50	CSMBS1C50	740	
63	CSMBS1C63	740	

Current rating (Amps.)	Product Code	MRP (₹)	Std. Pkg. (Nos.)
3 Pole			
0.5	CSMBS3C0.5	2000	4
1	CSMBS3C1	2000	
2	CSMBS3C2	2000	
3	CSMBS3C3	2000	
4	CSMBS3C4	2000	
5	CSMBS3C5	2000	
6	CSMBS3C6	1600	
10	CSMBS3C10	1600	
16	CSMBS3C16	1600	
20	CSMBS3C20	1600	
25	CSMBS3C25	1600	
32	CSMBS3C32	1600	
40	CSMBS3C40	2370	
50	CSMBS3C50	2470	
63	CSMBS3C63	2470	



Current rating (Amps.)	Product Code	MRP (₹)	Std. Pkg. (Nos.)
1 Pole + N			
0.5	CSMBS1C0.5N	1370	6
1	CSMBS1C1N	1370	
2	CSMBS1C2N	1370	
3	CSMBS1C3N	1370	
4	CSMBS1C4N	1370	
5	CSMBS1C5N	1370	
6	CSMBS1C6N	970	
10	CSMBS1C10N	970	
16	CSMBS1C16N	970	
20	CSMBS1C20N	970	
25	CSMBS1C25N	970	
32	CSMBS1C32N	970	
40	CSMBS1C40N	1410	
50	CSMBS1C50N	1590	
63	CSMBS1C63N	1590	

Current rating (Amps.)	Product Code	MRP (₹)	Std. Pkg. (Nos.)
3 Pole + N			
0.5	CSMBS3C0.5N	2590	3
1	CSMBS3C1N	2590	
2	CSMBS3C2N	2590	
3	CSMBS3C3N	2590	
4	CSMBS3C4N	2590	
5	CSMBS3C5N	2590	
6	CSMBS3C6N	2030	
10	CSMBS3C10N	2030	
16	CSMBS3C16N	2030	
20	CSMBS3C20N	2030	
25	CSMBS3C25N	2030	
32	CSMBS3C32N	2030	
40	CSMBS3C40N	2770	
50	CSMBS3C50N	2940	
63	CSMBS3C63N	2940	



Current rating (Amps.)	Product Code	MRP (₹)	Std. Pkg. (Nos.)
2 Pole			
0.5	CSMBS2C0.5	1420	6
1	CSMBS2C1	1420	
2	CSMBS2C2	1420	
3	CSMBS2C3	1420	
4	CSMBS2C4	1420	
5	CSMBS2C5	1420	
6	CSMBS2C6	1010	
10	CSMBS2C10	1010	
16	CSMBS2C16	1010	
20	CSMBS2C20	1010	
25	CSMBS2C25	1010	
32	CSMBS2C32	1010	
40	CSMBS2C40	1490	
50	CSMBS2C50	1690	
63	CSMBS2C63	1690	

Current rating (Amps.)	Product Code	MRP (₹)	Std. Pkg. (Nos.)
4 Pole			
0.5	CSMBS4C0.5	2760	3
1	CSMBS4C1	2760	
2	CSMBS4C2	2760	
3	CSMBS4C3	2760	
4	CSMBS4C4	2760	
5	CSMBS4C5	2760	
6	CSMBS4C6	2250	
10	CSMBS4C10	2250	
16	CSMBS4C16	2250	
20	CSMBS4C20	2250	
25	CSMBS4C25	2250	
32	CSMBS4C32	2250	
40	CSMBS4C40	3090	
50	CSMBS4C50	3190	
63	CSMBS4C63	3190	

Non Stockable item

WiNtrip2 Miniature Circuit Breaker

D-Series

High Inductive Load & High Inrush Current

[HSN Code: 8536]



Current rating (Amps.)	Product Code	MRP (₹)	Std. Pkg. (Nos.)
1 Pole			
0.5	CSMBS1D0.5	560	12
1	CSMBS1D1	560	
2	☒CSMBS1D2	560	
3	CSMBS1D3	560	
4	CSMBS1D4	560	
5	CSMBS1D5	560	
6	☒CSMBS1D6	460	
10	☒CSMBS1D10	460	
16	☒CSMBS1D16	460	
20	☒CSMBS1D20	460	
25	☒CSMBS1D25	460	
32	☒CSMBS1D32	460	
40	CSMBS1D40	780	
50	CSMBS1D50	880	
63	CSMBS1D63	880	

Current rating (Amps.)	Product Code	MRP (₹)	Std. Pkg. (Nos.)
3 Pole			
0.5	CSMBS3D0.5	2230	4
1	CSMBS3D1	2230	
2	CSMBS3D2	2230	
3	CSMBS3D3	2230	
4	CSMBS3D4	2230	
5	CSMBS3D5	2230	
6	☒CSMBS3D6	1760	
10	CSMBS3D10	1760	
16	☒CSMBS3D16	1760	
20	☒CSMBS3D20	1760	
25	☒CSMBS3D25	1760	
32	☒CSMBS3D32	1760	
40	☒CSMBS3D40	2670	
50	CSMBS3D50	2770	
63	☒CSMBS3D63	2770	



Current rating (Amps.)	Product Code	MRP (₹)	Std. Pkg. (Nos.)
1 Pole + N			
0.5	CSMBS1D0.5N	1410	6
1	CSMBS1D1N	1410	
2	CSMBS1D2N	1410	
3	CSMBS1D3N	1410	
4	CSMBS1D4N	1410	
5	CSMBS1D5N	1410	
6	CSMBS1D6N	1110	
10	CSMBS1D10N	1110	
16	CSMBS1D16N	1110	
20	CSMBS1D20N	1110	
25	CSMBS1D25N	1110	
32	☒CSMBS1D32N	1110	
40	CSMBS1D40N	1650	
50	CSMBS1D50N	1760	
63	☒CSMBS1D63N	1760	

Current rating (Amps.)	Product Code	MRP (₹)	Std. Pkg. (Nos.)
3 Pole + N			
0.5	CSMBS3D0.5N	2870	3
1	CSMBS3D1N	2870	
2	CSMBS3D2N	2870	
3	CSMBS3D3N	2870	
4	CSMBS3D4N	2870	
5	CSMBS3D5N	2870	
6	CSMBS3D6N	2620	
10	CSMBS3D10N	2620	
16	☒CSMBS3D16N	2620	
20	CSMBS3D20N	2620	
25	☒CSMBS3D25N	2620	
32	☒CSMBS3D32N	2620	
40	CSMBS3D40N	2900	
50	CSMBS3D50N	3040	
63	☒CSMBS3D63N	3040	



Current rating (Amps.)	Product Code	MRP (₹)	Std. Pkg. (Nos.)
2 Pole			
0.5	☒CSMBS2D0.5	1490	6
1	CSMBS2D1	1490	
2	☒CSMBS2D2	1490	
3	CSMBS2D3	1490	
4	☒CSMBS2D4	1490	
5	CSMBS2D5	1490	
6	☒CSMBS2D6	1190	
10	☒CSMBS2D10	1190	
16	☒CSMBS2D16	1190	
20	☒CSMBS2D20	1190	
25	☒CSMBS2D25	1190	
32	☒CSMBS2D32	1190	
40	CSMBS2D40	1730	
50	CSMBS2D50	1800	
63	☒CSMBS2D63	1800	

Current rating (Amps.)	Product Code	MRP (₹)	Std. Pkg. (Nos.)
4 Pole			
0.5	CSMBS4D0.5	2940	3
1	CSMBS4D1	2940	
2	CSMBS4D2	2940	
3	CSMBS4D3	2940	
4	CSMBS4D4	2940	
5	CSMBS4D5	2940	
6	CSMBS4D6	2700	
10	CSMBS4D10	2700	
16	☒CSMBS4D16	2700	
20	CSMBS4D20	2700	
25	CSMBS4D25	2700	
32	CSMBS4D32	2700	
40	☒CSMBS4D40	3280	
50	CSMBS4D50	3600	
63	☒CSMBS4D63	3600	

☒ Non Stockable item



WiNtrip2 Miniature Circuit Breaker

K-Series, 'C' Curve

IS/IEC 60947-2

Inductive load with surge current - Motor Circuit Applications

[HSN Code: 8536]



Current rating (Amps.)	Product Code	MRP (₹)	Std. Pkg. (Nos.)
1 Pole			
0.5	CSMBS1K0.5	570	12
1	CSMBS1K1	570	
2	CSMBS1K2	570	
3	CSMBS1K3	570	
4	CSMBS1K4	570	
5	CSMBS1K5	570	
6	CSMBS1K6	360	
10	CSMBS1K10	360	
16	CSMBS1K16	360	
20	CSMBS1K20	360	
25	CSMBS1K25	360	
32	CSMBS1K32	360	
40	CSMBS1K40	800	
50	CSMBS1K50	880	
63	CSMBS1K63	880	



Current rating (Amps.)	Product Code	MRP (₹)	Std. Pkg. (Nos.)
1 Pole + N			
0.5	CSMBS1K0.5N	1530	6
1	CSMBS1K1N	1530	
2	CSMBS1K2N	1530	
3	CSMBS1K3N	1530	
4	CSMBS1K4N	1530	
5	CSMBS1K5N	1530	
6	CSMBS1K6N	1090	
10	CSMBS1K10N	1090	
16	CSMBS1K16N	1090	
20	CSMBS1K20N	1090	
25	CSMBS1K25N	1090	
32	CSMBS1K32N	1090	
40	CSMBS1K40N	1560	
50	CSMBS1K50N	1760	
63	CSMBS1K63N	1760	



Current rating (Amps.)	Product Code	MRP (₹)	Std. Pkg. (Nos.)
2 Pole			
0.5	CSMBS2K0.5	1610	6
1	CSMBS2K1	1610	
2	CSMBS2K2	1610	
3	CSMBS2K3	1610	
4	CSMBS2K4	1610	
5	CSMBS2K5	1610	
6	CSMBS2K6	1160	
10	CSMBS2K10	1160	
16	CSMBS2K16	1160	
20	CSMBS2K20	1160	
25	CSMBS2K25	1160	
32	CSMBS2K32	1160	
40	CSMBS2K40	1730	
50	CSMBS2K50	1960	
63	CSMBS2K63	1960	

Current rating (Amps.)	Product Code	MRP (₹)	Std. Pkg. (Nos.)
3 Pole			
0.5	CSMBS3K0.5	2240	4
1	CSMBS3K1	2240	
2	CSMBS3K2	2240	
3	CSMBS3K3	2240	
4	CSMBS3K4	2240	
5	CSMBS3K5	2240	
6	CSMBS3K6	1850	
10	CSMBS3K10	1850	
16	CSMBS3K16	1850	
20	CSMBS3K20	1850	
25	CSMBS3K25	1850	
32	CSMBS3K32	1850	
40	CSMBS3K40	2700	
50	CSMBS3K50	2870	
63	CSMBS3K63	2870	

Current rating (Amps.)	Product Code	MRP (₹)	Std. Pkg. (Nos.)
3 Pole + N			
0.5	CSMBS3K0.5N	2890	3
1	CSMBS3K1N	2890	
2	CSMBS3K2N	2890	
3	CSMBS3K3N	2890	
4	CSMBS3K4N	2890	
5	CSMBS3K5N	2890	
6	CSMBS3K6N	2360	
10	CSMBS3K10N	2360	
16	CSMBS3K16N	2360	
20	CSMBS3K20N	2360	
25	CSMBS3K25N	2360	
32	CSMBS3K32N	2360	
40	CSMBS3K40N	3170	
50	CSMBS3K50N	3400	
63	CSMBS3K63N	3400	

Current rating (Amps.)	Product Code	MRP (₹)	Std. Pkg. (Nos.)
4 Pole			
0.5	CSMBS4K0.5	3090	3
1	CSMBS4K1	3090	
2	CSMBS4K2	3090	
3	CSMBS4K3	3090	
4	CSMBS4K4	3090	
5	CSMBS4K5	3090	
6	CSMBS4K6	2620	
10	CSMBS4K10	2620	
16	CSMBS4K16	2620	
20	CSMBS4K20	2620	
25	CSMBS4K25	2620	
32	CSMBS4K32	2620	
40	CSMBS4K40	3510	
50	CSMBS4K50	3790	
63	CSMBS4K63	3790	

Non Stockable item

Note: K- Series 'B' Curve POR (for prices please contact the nearest branch office.)



WiNtrip2 DC MCB

- 250V (1 Pole) & 500V (2 Pole), 6kA / 3kA Breaking Capacity
- Range: 6A~40A
- Standard Conformity: IEC60947-2:2016





WiNtrip2 Miniature Circuit Breaker

DC MCB-Series

[HSN Code: 8536]



Description	Current rating (Amps.)	Product Code	MRP (₹)	Std. Pkg. (Nos.)
1 Pole				
DC MCB SP 6A-250V	6	CSMBS1DC6-250	630	12
DC MCB SP 10A-250V	10	CSMBS1DC10-250	630	
DC MCB SP 16A-250V	16	CSMBS1DC16-250	630	
DC MCB SP 20A-250V	20	CSMBS1DC20-250	630	
DC MCB SP 25A-250V	25	CSMBS1DC25-250	630	
DC MCB SP 32A-250V	32	CSMBS1DC32-250	630	
DC MCB SP 40A-250V	40	CSMBS1DC40-250	880	
Shorting link		SHMT8101	120	
2 Pole				
DC MCB DP 6A-500V	6	CSMBS2DC6-500	1320	6
DC MCB DP 10A-500V	10	CSMBS2DC10-500	1320	
DC MCB DP 16A-500V	16	CSMBS2DC16-500	1320	
DC MCB DP 20A-500V	20	CSMBS2DC20-500	1320	
DC MCB DP 25A-500V	25	CSMBS2DC25-500	1320	
DC MCB DP 32A-500V	32	CSMBS2DC32-500	1320	
DC MCB DP 40A-500V	40	CSMBS2DC40-500	1890	
Shorting link		SHMT8101	120	

DC MCB-Series

[HSN Code: 8536]



Current rating (Amps.)	Product Code	MRP (₹)	Std. Pkg. (Nos.)
1 Pole			
0.5	CSMBS1DC0.5	660	12
1	CSMBS1DC1	660	
2	CSMBS1DC2	660	
3	CSMBS1DC3	660	
4	CSMBS1DC4	660	
5	CSMBS1DC5	660	
6	CSMBS1DC6	570	
10	CSMBS1DC10	570	
16	CSMBS1DC16	570	
20	CSMBS1DC20	570	
25	CSMBS1DC25	570	
32	CSMBS1DC32	570	
40	CSMBS1DC40	800	
50	CSMBS1DC50	930	
63	CSMBS1DC63	930	

Current rating (Amps.)	Product Code	MRP (₹)	Std. Pkg. (Nos.)
2 Pole			
0.5	CSMBS2DC0.5	1540	6
1	CSMBS2DC1	1540	
2	CSMBS2DC2	1540	
3	CSMBS2DC3	1540	
4	CSMBS2DC4	1540	
5	CSMBS2DC5	1540	
6	CSMBS2DC6	1200	
10	CSMBS2DC10	1200	
16	CSMBS2DC16	1200	
20	CSMBS2DC20	1200	
25	CSMBS2DC25	1200	
32	CSMBS2DC32	1200	
40	CSMBS2DC40	1670	
50	CSMBS2DC50	1880	
63	CSMBS2DC63	1880	

Accessories (Site fit-able)

[HSN Code: 8538]

Description	Product Code	Configuration	Type of contact	Fitment	Module Size	Suitable MCB Rating (A)	MRP (₹)
Auxiliary Contact	CSMBAXSF1	1NO-1NC	Changeover	Right	9 mm	Wintrip2 0.5-63	1110
Auxiliary Contact	CSMBAXSF2	2NO-2NC	Changeover	Right	9 mm	Wintrip2 0.5-63	1160
Auxiliary Contact	CSMBAXSF11	1NO-1NC	Potential free	Left	18 mm	Wintrip2 0.5-63	1110
Alarm Contact	CSMBALSF1	1 Changeover	Changeover	Right	9 mm	Wintrip2 0.5-63	960
Shunt Trip	CSMBS01DCSF	-	-	Left	18 mm	Wintrip2 0.5-63	1320
Shunt Trip	CSMBS02DCSF	-	-	Left	18 mm	Wintrip2 0.5-63	1320
Shunt Trip	CSMBS04DCSF	-	-	Left	18 mm	Wintrip2 0.5-63	1320
Shunt Trip	CSMBS220ACSF	-	-	Left	18 mm	Wintrip2 0.5-63	1320

☒ Non Stockable item

WiNtrip2 Isolator (IEC 60947-3)

[HSN Code: 8536]



Current rating (Amps.)	Product Code	MRP (₹)	Std. Pkg. (Nos.)
1 Pole			
25	CSMBS1SD25	380	12
40	CSMBS1SD40	500	
63	CSMBS1SD63	550	
80	CSMBS1SD80	620	
100	CSMBS1SD100	720	
125	CSMBS1SD125	840	

Current rating (Amps.)	Product Code	MRP (₹)	Std. Pkg. (Nos.)
3 Pole			
25	CSMBS3SD25	1190	4
40	CSMBS3SD40	1360	
63	CSMBS3SD63	1520	
80	CSMBS3SD80	1740	
100	CSMBS3SD100	1800	
125	CSMBS3SD125	1900	



Current rating (Amps.)	Product Code	MRP (₹)	Std. Pkg. (Nos.)
2 Pole			
25	CSMBS2SD25	630	6
40	CSMBS2SD40	700	
63	CSMBS2SD63	880	
80	CSMBS2SD80	1110	
100	CSMBS2SD100	1140	
125	CSMBS2SD125	1270	

Current rating (Amps.)	Product Code	MRP (₹)	Std. Pkg. (Nos.)
4 Pole			
25	CSMBS4SD25	1250	3
40	CSMBS4SD40	1550	
63	CSMBS4SD63	1700	
80	CSMBS4SD80	2100	
100	CSMBS4SD100	2130	
125	CSMBS4SD125	2350	

[HSN Code: 8536]



Current rating (Amps.)	Product Code	MRP (₹)	Std. Pkg. (Nos.)
1 Pole			
25	CSMBS1ISO25	340	12
40	CSMBS1ISO40	450	
63	CSMBS1ISO63	500	
80	CSMBS1ISO80	560	
100	CSMBS1ISO100	650	
125	CSMBS1ISO125	760	

Current rating (Amps.)	Product Code	MRP (₹)	Std. Pkg. (Nos.)
3 Pole			
25	CSMBS3ISO25	1050	4
40	CSMBS3ISO40	1200	
63	CSMBS3ISO63	1350	
80	CSMBS3ISO80	1540	
100	CSMBS3ISO100	1590	
125	CSMBS3ISO125	1680	



Current rating (Amps.)	Product Code	MRP (₹)	Std. Pkg. (Nos.)
2 Pole			
25	CSMBS2ISO25	570	6
40	CSMBS2ISO40	630	
63	CSMBS2ISO63	790	
80	CSMBS2ISO80	1000	
100	CSMBS2ISO100	1020	
125	CSMBS2ISO125	1140	

Current rating (Amps.)	Product Code	MRP (₹)	Std. Pkg. (Nos.)
4 Pole			
25	CSMBS4ISO25	1110	3
40	CSMBS4ISO40	1370	
63	CSMBS4ISO63	1510	
80	CSMBS4ISO80	1860	
100	CSMBS4ISO100	1890	
125	CSMBS4ISO125	2090	

Available till the stock last



Higher Rating Miniature Circuit Breakers (IEC 60947-2)

[HSN Code: 8536]



Current rating (Amps.)	Product Code	MRP (₹)	Std. Pkg. (Nos.)
1 Pole			
80	CSMBH1C80	2700	3
100	CSMBH1C100	3030	
125	CSMBH1C125	3280	
2 Pole			
80	CSMBH2C80	6000	3
100	CSMBH2C100	6410	
125	CSMBH2C125	7050	

Current rating (Amps.)	Product Code	MRP (₹)	Std. Pkg. (Nos.)
3 Pole			
80	CSMBH3C80	9470	1
100	CSMBH3C100	10090	
125	CSMBH3C125	11200	
4 Pole			
80	CSMBH4C80	12050	1
100	CSMBH4C100	12570	
125	CSMBH4C125	14190	

Accessories (Site fit-able)							[HSN Code: 8538]
Description	Product Code	Configuration	Type of contact	Fitment	Module Size	Suitable MCB Rating (A)	MRP (₹)
Auxiliary Contact	CSMBAXHSF1	1NO-1NC	Changeover	Right	9 mm	Wintrip2 80-100	1210
Auxiliary Contact	CSMBAXHSF2	2NO-2NC	Changeover	Right	9 mm	Wintrip2 80-100	1260
Alarm Contact	CSMBALHSF1	1 Changeover	Changeover	Right	9 mm	Wintrip2 80-100	1210
Shunt Trip	CSMBHS012DCSF	-	-	Left	18 mm	Wintrip2 80-100	1420
Shunt Trip	CSMBHS024DCSF	-	-	Left	18 mm	Wintrip2 80-100	1420
Shunt Trip	CSMBHS048DCSF	-	-	Left	18 mm	Wintrip2 80-100	1420
Shunt Trip	CSMBHS220ACSF	-	-	Left	18 mm	Wintrip2 80-100	1420

Wintrip MCB Type Changeover Switch

[HSN Code: 8536]



Description	Pole	Rating (Amps.)	Product Code	MRP (₹)	Std. Pkg. (Nos.)
2 Pole					
Two way centre OFF Changeover Switch	2	25	CSCOS2P25A	1940	6
Two way centre OFF Changeover Switch	2	40	CSCOS2P40A	2870	
Two way centre OFF Changeover Switch	2	63	CSCOS2P63A	3330	
4 Pole					
Two way centre OFF Changeover Switch	4	25	CSCOS4P25A	3660	3
Two way centre OFF Changeover Switch	4	40	CSCOS4P40A	5490	
Two way centre OFF Changeover Switch	4	63	CSCOS4P63A	5890	

[HSN Code: 8536]

SmartSol Mini MCB DP



Description	Current rating (Amps.)	Reference	MRP (₹)
DP "C" 6-32A Mini MCB with Enclosure	6-32	CSMBSS2C6-32	650
SPN "C" 6-32A Mini MCB with Enclosure	6-32	CSMBSS1C6-32*N	650

Non Stockable item

WiNtrip Residual Current Circuit Breaker



2 Pole, 30mA 10kA			[HSN Code: 8536]
Current rating (Amps.)	Product Code	MRP (₹)	Std. Pkg. (Nos.)
10	CSRB2P10A30-10kA	3630	6
16	CSRB2P16A30-10kA	3630	
20	☒CSRB2P20A30-10kA	3630	
25	CSRB2P25A30-10kA	3740	
32	CSRB2P32A30-10kA	3820	
40	CSRB2P40A30-10kA	3850	
63	CSRB2P63A30-10kA	5140	
80	☒CSRB2P80A30-10kA	7670	
100	☒CSRB2P100A30-10kA	7710	

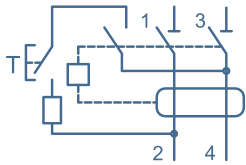

2 Pole, 100mA 10kA			[HSN Code: 8536]
Current rating (Amps.)	Product Code	MRP (₹)	Std. Pkg. (Nos.)
10	☒CSRB2P10A100-10kA	3630	6
16	CSRB2P16A100-10kA	3630	
20	☒CSRB2P20A100-10kA	3630	
25	CSRB2P25A100-10kA	3740	
32	CSRB2P32A100-10kA	3820	
40	CSRB2P40A100-10kA	3850	
63	CSRB2P63A100-10kA	5140	
80	CSRB2P80A100-10kA	7670	
100	☒CSRB2P100A100-10kA	7710	



Test Button



Bi-connect Terminals

2 Pole, 300mA 10kA			[HSN Code: 8536]
Current rating (Amps.)	Product Code	MRP (₹)	Std. Pkg. (Nos.)
10	CSRB2P10A300-10kA	3640	6
16	☒CSRB2P16A300-10kA	3640	
20	CSRB2P20A300-10kA	3650	
25	CSRB2P25A300-10kA	3940	
32	☒CSRB2P32A300-10kA	3980	
40	☒CSRB2P40A300-10kA	4220	
63	☒CSRB2P63A300-10kA	5290	
80	☒CSRB2P80A300-10kA	7710	
100	CSRB2P100A300-10kA	7750	

☒ Non Stockable item



WiNtrip Residual Current Circuit Breaker



4 Pole, 30mA 10kA			[HSN Code: 8536]
Current rating (Amps.)	Product Code	MRP (₹)	Std. Pkg. (Nos.)
10	☒CSR4P10A30-10kA	4520	3
16	CSR4P16A30-10kA	4540	
20	☒CSR4P20A30-10kA	4580	
25	CSR4P25A30-10kA	4800	
32	CSR4P32A30-10kA	4810	
40	CSR4P40A30-10kA	4920	
63	CSR4P63A30-10kA	5590	
80	CSR4P80A30-10kA	8450	
100	☒CSR4P100A30-10kA	8680	

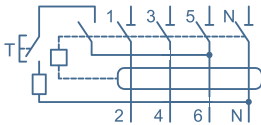

4 Pole, 100mA 10kA			[HSN Code: 8536]
Current rating (Amps.)	Product Code	MRP (₹)	Std. Pkg. (Nos.)
10	☒CSR4P10A100-10kA	4520	3
16	☒CSR4P16A100-10kA	4540	
20	CSR4P20A100-10kA	4580	
25	CSR4P25A100-10kA	4800	
32	CSR4P32A100-10kA	4810	
40	CSR4P40A100-10kA	4920	
63	CSR4P63A100-10kA	5590	
80	CSR4P80A100-10kA	8450	
100	CSR4P100A100-10kA	8680	



Test Button



Bi-connect Terminals

4 Pole, 300mA 10kA			[HSN Code: 8536]
Current rating (Amps.)	Product Code	MRP (₹)	Std. Pkg. (Nos.)
10	☒CSR4P10A300-10kA	4540	3
16	☒CSR4P16A300-10kA	4570	
20	CSR4P20A300-10kA	4600	
25	☒CSR4P25A300-10kA	5020	
32	☒CSR4P32A300-10kA	5020	
40	CSR4P40A300-10kA	5240	
63	CSR4P63A300-10kA	5630	
80	☒CSR4P80A300-10kA	8510	
100	CSR4P100A300-10kA	8720	

NOTE:

1. MCB in bulk packing are available on request.
2. The industrial MCB will have non-retail (NR) suffix in their part codes.
3. For MCB technical Data sheet, Dimesion details etc. please refer product catalogue or contact nearest Branch Office.

☒ Non Stockable item



ACCL

Automatic Changeover with Current Limiter

- Complying to IEC 60947-6 & IEC 60947-3
- Utilization Category AC 32A
- Rating : Mains - 30A, DG - 0.5A~30A
- Individual LED for Mains & DG
- Quick Transfer Time
- Fault Annunciation
- Higher Electrical Life
- Low Blackout Time
- Din Rail Mounting
- Auto Reset Facility
- Can be used for New Installations as Well as for Retrofits

ACCL			[HSN Code: 8536]
Product Code	Mains Rating (Amps.)	Genset Rating (Amps.)	MRP (₹)
TCALSS005	30	0.5	4120
TCALSS010	30	1	4120
TCALSS015	30	1.5	4120
TCALSS025	30	2.5	4120
TCALSS030	30	3	4120
TCALSS040	30	4	4120
TCALSS050	30	5	4120
TCALSS060	30	6	4120
TCALSS080	30	8	4120
TCALSS090	30	9	4120
TCALSS100	30	10	4120
TCALSS150	30	15	4120
TCALSS200	30	20	4120
TCALSS250	30	25	4120
TCALSS300	30	30	4120

 Non Stockable item



Epitome IP43 Distribution Boards

for Residential & Industrial applications

- Heavy duty Gasket to inhibit the entry of foreign particles
- Choice of multiple incomers as MCB/Isolator/RCCB
- Adequate wiring space
- Also available with lock & key mechanism for safety

EPIHOME IP43 Distribution Boards			[HSN Code: 8537]
Description	Product Code	No. of Modules (Incomer+Outgoing)	MRP (₹)
SPN Distribution Board			
SPN Double Door 04 Way IP43 DB	CSDBSPNPWXDD04	4	2350
SPN Double Door 06 Way IP43 DB	CSDBSPNPWXDD06	6	2750
SPN Double Door 08 Way IP43 DB	CSDBSPNPWXDD08	8	2970
SPN Double Door 10 Way IP43 DB	CSDBSPNPWXDD10	10	3580
SPN Double Door 12 Way IP43 DB	CSDBSPNPWXDD12	12	3760
SPN Double Door 16 Way IP43 DB	CSDBSPNPWXDD16	16	4790
SPN Double Door 20 Way IP43 DB	CSDBSPNPWXDD20	20	6470
SPN Double Door 24 Way IP43 DB	CSDBSPNPWXDD24	24	7330
TPN Distribution Board			
TPNH Double Door 04 Way IP43 DB	CSDBTPNHPWXDD04	8+12	6330
TPNH Double Door 06 Way IP43 DB	CSDBTPNHPWXDD06	8+18	7910
TPNH Double Door 08 Way IP43 DB	CSDBTPNHPWXDD08	8+24	9830
TPNH Double Door 12 Way IP43 DB	CSDBTPNHPWXDD12	8+36	13320
TPNH Double Door 16 Way IP43 DB	CSDBTPNHPWXDD16	8+48	17360

Non Stockable item

EPIc Distribution Board			
			[HSN Code: 8537]
Description	Product Code	Total Modules	MRP (₹)
SPN Distribution Board			
04 Way SPN Single Door	CSDBSPNPESD04	4	1120
06 Way SPN Single Door	CSDBSPNPESD06	6	1220
08 Way SPN Single Door	CSDBSPNPESD08	8	1430
12 Way SPN Single Door	CSDBSPNPESD12	12	1830
16 Way SPN Single Door	CSDBSPNPESD16	16	2340
SPN Distribution Board			
04 Way SPN Double Door	CSDBSPNPEDD04	4	1860
06 Way SPN Double Door	CSDBSPNPEDD06	6	2010
08 Way SPN Double Door	CSDBSPNPEDD08	8	2320
10 Way SPN Double Door	CSDBSPNPEDD10	10	2810
12 Way SPN Double Door	CSDBSPNPEDD12	12	3060
16 Way SPN Double Door	CSDBSPNPEDD16	16	3800
TPN-Horizontal Distribution Board			
04 Way TPNH Single Door	CSDBTPNHPESD04	20	3520
06 Way TPNH Single Door	CSDBTPNHPESD06	26	4410
08 Way TPNH Single Door	CSDBTPNHPESD08	32	5170
12 Way TPNH Single Door	CSDBTPNHPESD12	44	6970
TPN-Horizontal Distribution Board			
04 Way TPNH Double Door	CSDBTPNHPEDD04	20	5100
06 Way TPNH Double Door	CSDBTPNHPEDD06	26	6280
08 Way TPNH Double Door	CSDBTPNHPEDD08	32	7520
12 Way TPNH Double Door	CSDBTPNHPEDD12	44	10240
TPN-Vertical Distribution Board			
04 Way TPNH Double Door	CSDBTPNVPECGDD04	20	9280
06 Way TPNH Double Door	CSDBTPNVPECGDD06	26	10940
08 Way TPNH Double Door	CSDBTPNVPECGDD08	32	12720
12 Way TPNH Double Door	CSDBTPNVPECGDD12	44	16210



EPIc-F Distribution Board			
			[HSN Code: 8537]
Description	Product Code	No. of Modules (Incomer+Outgoing)	MRP (₹)
SPN Distribution Board			
04 Way SPN Single Door	CSDBSPNPESD04	4	1160
06 Way SPN Single Door	CSDBSPNPESD06	6	1270
08 Way SPN Single Door	CSDBSPNPESD08	8	1470
12 Way SPN Single Door	CSDBSPNPESD12	12	1930
16 Way SPN Single Door	CSDBSPNPESD16	16	2520
SPN Distribution Board			
04 Way SPN Double Door	CSDBSPNPGDD04	4	1890
06 Way SPN Double Door	CSDBSPNPGDD06	6	2120
08 Way SPN Double Door	CSDBSPNPGDD08	8	2370
10 Way SPN Double Door	CSDBSPNPGDD10	10	2870
12 Way SPN Double Door	CSDBSPNPGDD12	12	3120
16 Way SPN Double Door	CSDBSPNPGDD16	16	3890
TPN-Horizontal Distribution Board			
04 Way TPNH Single Door	CSDBTPNHPSD04	8+12	3750
06 Way TPNH Single Door	CSDBTPNHPSD06	8+18	4670
08 Way TPNH Single Door	CSDBTPNHPSD08	8+24	5440
12 Way TPNH Single Door	CSDBTPNHPSD12	8+36	7340
TPN-Horizontal Distribution Board			
04 Way TPNH Double Door	CSDBTPNHPCGDD04	8+12	5090
06 Way TPNH Double Door	CSDBTPNHPCGDD06	8+18	6340
08 Way TPNH Double Door	CSDBTPNHPCGDD08	8+24	7720
12 Way TPNH Double Door	CSDBTPNHPCGDD12	8+36	10800



CSDBTPNHPSD06 Non Stockable item



Distribution Board

C&S WiNclass Distribution Board (Deep Drawn)



SPN WiNclass Distribution Board			[HSN Code: 8537]
Description	Product Code	No. of Modules (Incomer+Outgoing)	MRP (₹)
2+04 Way Single Door	CSDBSPNSD04S	2+04	1480
2+08 Way Single Door	CSDBSPNSD08S	2+08	1850
2+12 Way Single Door	CSDBSPNSD12S	2+12	2540
2+14 Way Single Door	CSDBSPNSD16S	2+14	3160
2+04 Way Double Door	CSDBSPNDD04S	2+04	2400
2+08 Way Double Door	CSDBSPNDD08S	2+08	2990
2+12 Way Double Door	CSDBSPNDD12S	2+12	3910
2+14 Way Double Door	CSDBSPNDD16S	2+14	5120



TPN WiNclass Distribution Board			
04 Way Single Door DB	 CSDBTPNHSD04S	8+12	4820
06 Way Single Door DB	 CSDBTPNHSD06S	8+18	5780
08 Way Single Door DB	 CSDBTPNHSD08S	8+24	6340
12 Way Single Door DB	 CSDBTPNHSD12S	8+36	8380
16 Way Single Door DB	 CSDBTPNHSD16S	8+48	10490
04 Way Double Door DB	CSDBTPNHDD04SN	4+12	6330
04 Way Double Door DB	CSDBTPNHDD04S	8+12	6400
06 Way Double Door DB	CSDBTPNHDD06S	8+18	8010
08 Way Double Door DB	CSDBTPNHDD08S	8+24	10090
12 Way Double Door DB	CSDBTPNHDD12S	8+36	14360
16 Way Double Door DB	 CSDBTPNHDD16S	8+48	18120



Polycarbonate Cover Consumer Unit DB			[HSN Code: 8537]
Description	Product Code	No. of Modules (Incomer+Outgoing)	MRP (₹)
SPN WC 06 Way SD With Acrylic Door	CSDBSPNSDCA06	6	2150
SPN WC 08 Way SD With Acrylic Door	CSDBSPNSDCA08	8	2400
SPN WC 12 Way SD With Acrylic Door	CSDBSPNSDCA12	12	3100
SPN WC 16 Way SD With Acrylic Door	CSDBSPNSDCA16	16	3950

 Non Stockable item

WiNtrip Distribution Board



Phase Selector Distribution Board - TPN Phase Selector DD DB for incorporating MCB / Isolator / RCCB, equipped with 3 Nos 63A Phase Selector Switches & 3 No Piano Switches			[HSN Code: 8537]
Description	Product Code	MRP (₹)	
4 Way DD with 63A Rotary Switch	CSDBPHSCDD04RS63	18450	
6 Way DD with 63A Rotary Switch	CSDBPHSCDD06RS63	18880	
8 Way DD with 63A Rotary Switch	CSDBPHSCDD08RS63	20830	
12 Way DD with 63A Rotary Switch	CSDBPHSCDD12RS63	23080	
4 Way DD with 40A Rotary Switch	CSDBPHSCDD04RS40	18340	
6 Way DD with 40A Rotary Switch	CSDBPHSCDD06RS40	18550	
8 Way DD with 40A Rotary Switch	CSDBPHSCDD08RS40	20640	
12Way DD with 40A Rotary Switch	CSDBPHSCDD12RS40	22690	
4 Way DD without Rotary Switch	CSDBPHSCDD04	15770	
6 Way DD without Rotary Switch	CSDBPHSCDD06	16170	
8 Way DD without Rotary Switch	CSDBPHSCDD08	17790	
12 Way DD without Rotary Switch	CSDBPHSCDD12	20330	



VTPN Distribution Board (with provision for WiNtrip2 MCB)			
Description	Product Code	No. of Modules (Incomer+Outgoing)	MRP (₹)
4 way Double Door	CSDBTPNVDD04S	8+12	16400
6 way Double Door	CSDBTPNVDD06S	8+18	18800
8 way Double Door	CSDBTPNVDD08S	8+24	20780
12 way Double Door	CSDBTPNVDD12S	8+36	27830



VTPN Distribution Board (with provision for MCCB WiNbreak1 as incomer & WiNtrip2 MCB as outgoing)			[HSN Code: 8537]
Description	Product Code	MRP (₹)	
DB MCCB AS I/C 100A DD04 Way	CSDBMCCB125PDD04S	15970	
DB MCCB AS I/C 100A DD08 Way	CSDBMCCB125PDD08S	17990	
DB MCCB AS I/C 100A DD12 Way	CSDBMCCB125PDD12S	24870	
DB MCCB AS I/C 250A DD04 Way	CSDBMCCB250PDD04S	19170	
DB MCCB AS I/C 250A DD08 Way	CSDBMCCB250PDD08S	24960	
DB MCCB AS I/C 250A DD12 Way	CSDBMCCB250PDD12S	31180	



Distribution Board

WiNtrip Distribution Board



Selection Table for MCCB as Incomer VTPN Distribution Boards				
WiNbreak 1 MCCB	Description	Product Code	Type/ Breaking Capacity Ics=100%Icu	MCCB Rating (A)
	CSE1M125ATM3P-*, CSE1M125ATM4P-*, CSE1NN125ATM3P-*, CSE1NN125ATM4P-*, CSE1NN125ETM3P-*, CSE1NN125ETM4P-*, CSE1S125ETM3P-*, CSE1S125ETM4P-*		CSDBMCCB125PDD04S	25kA, 36kA & 50kA
		CSDBMCCB125PDD08S		
		CSDBMCCB125PDD12S		
CSE2M250ATM3P-*, CSE2M250A M4P-*, CSE2NN250ATM3P-*, CSE2NN250ATM4P-*, CSE2NN250ETM3P-*, CSE2NN250ETM4P-*, CSE2S250ETM3P-*, CSE2S250ETM4P-*, CSE2SX250ETM3P-*, CSE2SX250ETM4P-*, CSE2SX250ATM3P-*, CSE2SX250ATM4P-*		CSDBMCCB250PDD04S	25kA, 36kA & 50kA	160, 200, 250 & 63~160 80~100, 100~250
		CSDBMCCB250PDD08S		
		CSDBMCCB250PDD12S		
		CSDBMCCB250PDD12S		

NOTE: While Ordering, Replace "*" by current Rating.



7 Segment Distribution Board [HSN Code: 8537]			
Description	Product Code	No. of Modules (Incomer+Outgoing)	MRP (₹)
7 Segment TPN DD DB With Provision for FP MCB/Isolator/RCCB as incomer, DP MCB/Isolator/RCCB as sub incomer and SP MCBs as outgoing	<input checked="" type="checkbox"/> CSDB7SEGDD04	8+12+12	14460
	CSDB7SEGDD06	8+12+18	16280
	<input checked="" type="checkbox"/> CSDB7SEGDD08	8+12+24	18200
	<input checked="" type="checkbox"/> CSDB7SEGDD12	8+12+36	23110

Price on request : Prewired Distribution Board fitted with Busbar, Terminal Block for incoming/outgoing phase neutral & Earth duly wired with Provision for ISO/RCCB/MCB as incomer and SP outgoing (without MCBs)



*FLEXI (Tier) DBs (with Metal Door) [HSN Code: 8537]		
Description	Product Code	MRP (₹)
Flexi DD DB 2 Row 13 Modules	CSDBFLDD2R13	7940
Flexi DD DB 3 Row 13 Modules	CSDBFLDD3R13	9360
Flexi DD DB 4 Row 13 Modules	CSDBFLDD4R13	10340

*Without Wire bunch



PPI Distribution Board [HSN Code: 8537]			
Description	Product Code	No. of Modules (Incomer+Outgoing)	MRP (₹)
4 Way Double Door	<input checked="" type="checkbox"/> CSDBTPNPPIDD04	8+6+12	8210
6 Way Double Door	<input checked="" type="checkbox"/> CSDBTPNPPIDD06	8+6+18	10250
8 Way Double Door	CSDBTPNPPIDD08	8+6+24	12440
12 Way Double Door	CSDBTPNPPIDD12	8+6+36	14390

Non Stockable item

WiNtrip Distribution Board

WiNtrip Telephone & Television Socket Distribution Board		[HSN Code: 8537]
Description	Product Code	MRP (₹)
SPN 04 Way Tel & TV Socket DB (2+4)	CSDBSPNDDTELV04	4950
SPN 06 Way Tel & TV Socket DB (2+6)	CSDBSPNDDTELV06	5250
SPN 08 Way Tel & TV Socket DB (2+8)	CSDBSPNDDTELV08	5570
SPN 10 Way Tel & TV Socket DB (2+10)	CSDBSPNDDTELV10	5940
SPN 12 Way Tel & TV Socket DB (2+12)	CSDBSPNDDTELV12	6610
SPN 14 Way Tel & TV Socket DB (2+14)	CSDBSPNDDTELV14	6820
TPN 04 Way Tel & TV Socket DB (8+12)	CSDBTPNDDTELV04	8220
TPN 06 Way Tel & TV Socket DB (8+18)	CSDBTPNDDTELV06	9440
TPN 08 Way Tel & TV Socket DB (8+24)	CSDBTPNDDTELV08	10880
TPN 12 Way Tel & TV Socket DB (8+36)	CSDBTPNDDTELV12	14160



Cable End Box

WiNclass Cable End Box		
Description	Product Code	MRP (₹)
SPN Cable End Box		
SPN 4 Way	CSDBCSPNDD04S	1100
SPN 8 Way	CSDBCSPNDD08S	1360
SPN 12 Way	CSDBCSPNDD12S	1600
SPN 16 Way	CSDBCSPNDD16S	1920
TPNH Cable End Box		
TPNH 4 Way	CSDBCTPNHDD04SN	1430
TPNH 6 Way	CSDBCTPNHDD06S	1700
TPNH 8 Way	CSDBCTPNHDD08S	1980
TPNH 12 Way	CSDBCTPNHDD12S	2490
TPNH 16 Way	CSDBCTPNHDD16S	2970



New C&S / Epic Cable End Box		[HSN Code: 8537]
Description	Product Code	MRP (₹)
SPN Cable End Box		
SPN 4 Way	CSDBCSPNPDD04	910
TPNH 6 Way	CSDBCSPNPDD06	1020
SPN 8 Way	CSDBCSPNPDD08	1150
SPN 12 Way	CSDBCSPNPDD12	1420
SPN 16 Way	CSDBCSPNPDD16	1740
TPNH Cable End Box		
TPNH 4 Way	CSDBCTPNHPDD04	1480
TPNH 6 Way	CSDBCTPNHPDD06	1710
TPNH 8 Way	CSDBCTPNHPDD08	1940
TPNH 12 Way	CSDBCTPNHPDD12	2480



EPIc TPNV Cable End Box		
Description	Product Code	MRP (₹)
CABLE END BOX FOR CSDBTPNVPEDD 04~12 WAY DB	CSDBCTPNVPEDD	2100

PPI Kit			[HSN Code: 8537]
Description	Product Code	MRP (₹)	
PPI KIT TO CONVERT TPNHP/TPNHPE DD 04 TO DD 02 WAY	CSDBPPPIKT01	2940	
PPI KIT TO CONVERT TPNHP/TPNHPE DD 06 TO DD 04 WAY	CSDBPPPIKT02	3310	
PPI KIT TO CONVERT TPNHP/TPNHPE DD 08 TO DD 06 WAY	CSDBPPPIKT03	3720	
PPI KIT TO CONVERT TPNHP/TPNHPE DD 12 TO DD 10 WAY	CSDBPPPIKT04	4470	

 Non Stockable item



Plug & Socket, DB



WiNtrip Plug and Socket DBs (without MCB) [HSN Code: 8537]			
Powder Coated Sheet Metal Deep Drawn DBs with Plug & Socket including insulated Neutral link, adjustable Din Rail and connecting links.			
Description	Product Code	MRP (₹)	Std. Pkg. (No.s)
10Amp SPN	CSDBPSSPN010	1670	12
20Amp SPN	CSDBPSSPN020	1670	12
20Amp SPN (SP Cutout)	CSDBPSSPN020SP	1670	12
20Amp TPN	CSDBPSTPN020	4030	6
30Amp TPN	CSDBPSTPN030	4430	6



WiNtrip Plug and Sockets (Metal Clad) [HSN Code: 8537]			
Description	Product Code	MRP (₹)	Std. Pkg. (No.s)
10Amp SPN Plug	CSDBPSPN010	340	36
10Amp SPN Socket	CSDBSSPN010	330	36
20Amp SPN Plug	CSDBPSPN020	360	36
20Amp SPN Socket	CSDBSSPN020	430	36
20Amp TPN Plug	CSDBPTPN020	440	36
20Amp TPN Socket	CSDBSTPN020	440	36
30Amp TPN Plug	CSDBPTPN030	690	36
30Amp TPN Socket	CSDBSTPN030	690	36



WiNtrip Metal Enclosures (with Din Rail) [HSN Code: 8537]			
For Mounting WiNtrip MCBs / RCCBs / Isolators			
Description	Product Code	MRP (₹)	Std. Pkg. (No.s)
SP Enclosure	CSDBMCBESP	580	24
DP Enclosure	CSDBMCBEDP	580	24
TP Enclosure	CSDBMCBETP	680	12
FP Enclosure	CSDBMCBEFP	680	12



WiNtrip Plastic Enclosure without MCB [HSN Code: 8537]		
Description	Product Code	MRP (₹)
Plastic MCB Enclosure SP&DP/STD	CSDBMCBEPPD	230
Plastic MCB Enclosure TP&FP/STD	CSDBMCBEPPP	310

MCB Enclosure IP55 [HSN Code: 8537]			
4 Pole Enclosure			
Description	Product Code	MRP (₹)	Std. Pkg. (No.s)
MCB Enclosure IP55 04 Way	CSDBEP04	2300	1

Non Stockable item

elusio
SWITCHES



Born Green

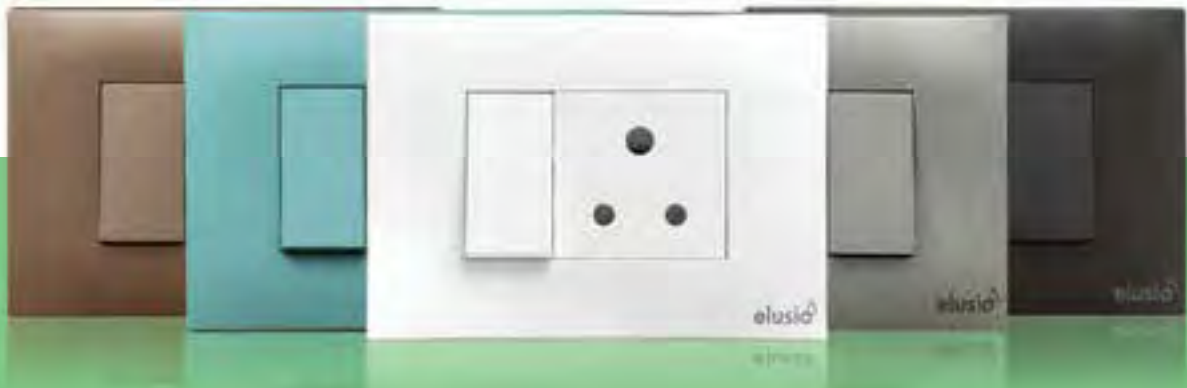

*T&C Apply

Stylish and eco-friendly.
30% more switch.
upto 3 times more switching.



FRONT MOUNT
& REMOVAL OPTION



SLEEK
DESIGN



UNBREAKABLE
DESIGNS



SMOOTH
TO TOUCH

Colors available in White, Elusio Green, Champagne, Dark Grey & Charcoal Black

Switches								
Product Code	HSN Code	Description	Rating	Module	MRP (₹)			Std. Pkg. (Nos.)
					White	Colour	Jungle Green	
CE20113NR	85361010	6AX Switch SP 1 way	6AX	1M	125	164	189	20
CE20114NR	85361010	6AX Switch SP 1 way with Indicator	6AX	1M	162	186	214	
CE20123NR	85361010	6AX Switch SP 2 way	6AX	1M	178	202	232	
CE20568NR	85361010	10AX Switch SP 1 way	10AX	1M	144	189	217	
CE20569NR	85361010	10AX Switch SP 1 way with Indicator	10AX	1M	186	214	246	
CE20571NR	85361010	10AX Switch SP 2 way	10AX	1M	205	232	267	
CE20573NR	85361020	16AX Switch SP 1 way	16AX	1M	170	194	223	
CE20574NR	85361020	16AX Switch SP 1 way with Indicator	16AX	1M	224	240	276	
CE20578NR	85361020	16AX Switch SP 2 way	16AX	1M	250	274	315	
CE20580NR	85361020	20AX Switch SP 1 way	20AX	1M	196	223	256	
CE20581NR	85361020	20AX Switch SP 2 way	20AX	1M	288	315	362	10
CE20584NR	85361020	20AX Switch SP 1 way with Indicator	20AX	1M	258	276	317	
CE20115NR	85361010	6AX Switch SP 1 way with Indicator	6AX	2M	210	225	259	
CE20124NR	85361010	6AX Switch SP 2 way	6AX	2M	203	243	280	
CE20570NR	85361010	10AX Switch SP 1 way with Indicator	10AX	2M	242	259	298	
CE20572NR	85361010	10AX Switch SP 2 way	10AX	2M	233	279	322	
CE20575NR	85361020	16AX Switch SP 1 way with Indicator	16AX	2M	221	261	300	
CE20579NR	85361020	16AX Switch SP 2 way	16AX	2M	258	298	343	
CE20582NR	85361020	20AX Switch SP 1 way	20AX	2M	240	270	340	
CE20583NR	85361020	20AX Switch SP 2 way	20AX	2M	297	343	394	
CE20121NR	85361020	32A DP Switch with Indicator	32A	2M	615	797	916	
Bell Push Switches								
Product Code	HSN Code	Description	Rating	Module	MRP (₹)			Std. Pkg. (Nos.)
					White	Colour	Jungle Green	
CE20509NR	85361010	6A Bell Push Switch	6A	1M	137	160	184	20
CE20508NR	85361010	6A Bell Push Switch with Indicator	6A	1M	164	188	216	
CE20510NR	85361010	6A Bell Push Switch	6A	2M	160	199	229	10
CE20511NR	85361010	6A Bell Push Switch with Indicator	6A	2M	188	227	261	
Blanking / Phase Indicator								
Product Code	HSN Code	Description	Rating	Module	MRP (₹)			Std. Pkg. (Nos.)
					White	Colour	Jungle Green	
CE20056NR	85361010	Blanking Plate		1M	44	54	62	40
CE20631NR	85361010	Phase Indicator Red		1M	429	450	518	20
Fan Regulator / Dimmer								
Product Code	HSN Code	Description	Rating	Module	MRP (₹)			Std. Pkg. (Nos.)
					White	Colour	Jungle Green	
CE20827NR	85361010	4 Step Fan Regulator	100W	1M	446	466	535	20
CE20826NR	85361010	5 Step Fan Regulator	100W	2M	570	615	708	10
CE20828NR	85361010	5 Step Fan Regulator	120W	2M	749	794	887	10
CE20804NR	85361010	Rotary Dimmer	300W	1M	618	664	763	20
CE20801NR	85361010	Rotary Dimmer	500W	2M	716	795	915	10
Sockets								
Product Code	HSN Code	Description	Rating	Module	MRP (₹)			Std. Pkg. (Nos.)
					White	Colour	Jungle Green	
CE20370NR	85361020	6A 3 Pin Socket	6A	2M	175	287	330	10
CE20352NR	85361020	6/16A 3 Pin Socket	6/16A	2M	289	345	396	
CE20354NR	85361020	6/16A 3 Pin Socket- Projected	6/16A	2M	305	362	416	10
CE20358NR	85361020	13A Universal Socket	13A	2M	175	287	330	
TV / Telephone / Computer / HDMI / VGA / USB / Night Lamp / Skirt Light								
Product Code	HSN Code	Description	Rating	Module	MRP (₹)			Std. Pkg. (Nos.)
					White	Colour	Jungle Green	
CE20228NR	85361010	TV Socket		1M	107	129	148	20
CE20251NR	85361010	RJ 11 Telephone Socket		1M	101	124	142	
CE20272NR	85361010	RJ 45 Cat 6 Computer Socket	Cat 6	1M	1021	1060	1219	
CE20273NR	85361010	RJ 45 Cat 6a Computer Socket	Cat6a	1M	2005	2039	2345	
CE20276NR	85361010	HDMI Socket		1M	1228	1410	1622	10
CE20277NR	85361010	VGA Socket		1M	1223	1350	1553	
CE20275NR	85044030	USB Charger Socket (Fast Charging)	2.1A, A type	1M	1109	1404	1615	20
CE20633NR	94051090	Night Lamp		2M	450	490	564	10
CE20632NR	94051090	Skirt Light with LED		2M	623	680	782	

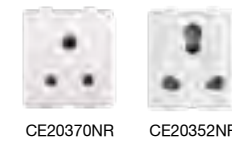



CE20364NR



CE20610NR CE20609NR CE20636NR



CE20825NR



CE20436NR CE20440NR



CE25803WHNR

Single Phase Motor Starter								
Product Code	HSN Code	Description	Rating	Module	MRP (₹)			Std. Pkg. (Nos.)
					White	Colour	Jungle Green	
CE20364NR	85361020	Motor Starter 16A	16A	2M	671	726	835	10
CE20366NR	85361020	Motor Starter 25A	25A	2M	671	726	835	

Hospitality Range								
Product Code	HSN Code	Description	Module	MRP (₹)			Std. Pkg. (Nos.)	
				White	Colour	Jungle Green		
CE20611NR	85361010	DND/CMR internal unit	1M	366	390	449	10	
CE20610NR	85361010	DND/CMR external unit	1M	586	599	689		
CE20609NR	85361010	DND/MMR Indicator	1M	419	450	518	20	
CE20116NR	85361010	6AX Switch SP 1 way MMR	1M	160	165	190		
CE20125NR	85361010	6AX Switch SP 2 way DND	1M	210	215	247		
CE20636NR	85361010	Buzzer	1M	605	680	782	3	
CE20825NR	85361010	16A Electronic Key Card Switch	2M	12750	14500	16675		

Modular - Miniature Circuit Breakers								
Product Code	HSN Code	Description	Rating	Module	MRP (₹)			Std. Pkg. (Nos.)
					White	Colour	Jungle Green	
CE20431NR	85361010	MCB 6A Single Pole 4.5kA	6A, C Curve	1M	398	433	498	12
CE20432NR	85361010	MCB 10A Single Pole 4.5kA	10A, C Curve	1M	398	433	498	
CE20433NR	85361010	MCB 16A Single Pole 4.5kA	16A, C Curve	1M	398	433	498	
CE20437NR	85361010	MCB 20A Single Pole 4.5kA	20A, C Curve	1M	398	433	498	
CE20435NR	85361010	MCB 25A Single Pole 4.5kA	25A, C Curve	1M	398	433	498	
CE20436NR	85361010	MCB 32A Single Pole 4.5kA	32A, C Curve	1M	398	433	498	
CE20438NR	85361010	MCB 6A Double Pole 4.5kA	6A, C Curve	2M	819	875	1006	6
CE20439NR	85361010	MCB 10A Double Pole 4.5kA	10A, C Curve	2M	819	875	1006	
CE20440NR	85361010	MCB 16A Double Pole 4.5kA	16A, C Curve	2M	819	875	1006	
CE20441NR	85361010	MCB 20A Double Pole 4.5kA	20A, C Curve	2M	819	875	1006	
CE20442NR	85361010	MCB 25A Double Pole 4.5kA	25A, C Curve	2M	819	875	1006	
CE20443NR	85361010	MCB 32A Double Pole 4.5kA	32A, C Curve	2M	819	875	1006	

Cover Plate with Support Plate								
Product Code	HSN Code	Description	Module	MRP (₹)			Std. Pkg. (Nos.)	
				White	Colour	Jungle Green		
CE25801WHNR	85381010	Cover & Support Plate	1M	119	239	275	10	
CE25802WHNR	85381010	Cover & Support Plate	2M	123	234	269		
CE25803WHNR	85381010	Cover & Support Plate	3M	153	295	339		
CE25804WHNR	85381010	Cover & Support Plate	4M	181	352	405		
CE25806WHNR	85381010	Cover & Support Plate	6M	251	553	635		
CE25808WHNR	85381010	Cover & Support Plate-Horizontal	8M	307	621	714		5
CE25809WHNR	85381010	Cover & Support Plate-Vertical	8MV	316	630	725		
CE25812WHNR	85381010	Cover & Support Plate	12M	526	1125	1294		
CE25816WHNR	85381010	Cover & Support Plate	16M	540	1212	1394		
CE25818WHNR	85381010	Cover & Support Plate	18M	682	1284	1477		

NOTE: For ordering color accessories suffix CB for Charcol Black, DG for Dark Grey, CZ for Champagne, JG for Jungle Green e.g. for ordering one module Charcol Black plate, the code would be CE25801CB



YOUR SAFETY MATTERS US

C&S Primo Plus Antibacterial Switches protects from Germs & Bacterial Infections



Primo Plus SWITCHES

- Available with Anti Bacterial features* Sleek design, compatible with PRIMO range of switches
- Highly aesthetic break free design
- Compatible to market boxes
- High gloss design
- Designed with front mounting and re-movable feature
- Ease of mounting
- Available in 1M -18M

DIVINO
S W I T C H E S

Primo Plus
SWITCHES

COMBI
WEATHER-PROOF ENCLOSURES.

primo
S W I T C H E S



CG20114PWNR



CG23114NR



CG20123PWNR



CG23123NR



CG20509PWNR



CG23509NR



CG20056PWNR



CG23056NR



CG20634PWNR



CG23634NR



CG20826PWNR



CG23826NR



CG20801PWNR



CG23801NR

Switches						
Product Code - Pure White / Grey	HSN Code	Description	Type	No. of Modules	MRP (₹)	Std. Pkg. (Nos.)
One-Way Switches						
CG20113PWNR / CG23113NR	85361010	1P-6A	General	1	107	20
CG20114PWNR / CG23114NR	85361010	1P-6A	Luminous	1	151	
CG20573PWNR / CG23573NR	85361020	1P-16A	General	1	174	
CG20574PWNR / CG23574NR	85361020	1P-16A	Luminous	1	200	
CG20117PWNR / CG23117NR	85361020	1P-25A	General	1	225	
CG20118PWNR / CG23118NR	85361020	1P-25A	Luminous	1	276	10
CG20120PWNR / CG23120NR	85361020	2P-32A	Luminous	2	407	
Two-Way Switches						
CG20123PWNR / CG23123NR	85361010	1P-6A	General	1	147	20
CG20578PWNR / CG23578NR	85361020	1P-16A	General	1	217	

Product Code - Pure White / Grey	HSN Code	Description	Type	No. of Modules	MRP (₹)	Std. Pkg. (Nos.)
Bell Push Switches						
CG20508PWNR / CG23508NR	85361010	1P-6A	Luminous	1	191	20
CG20509PWNR / CG23509NR	85361010	1P-6A	With Symbol	1	151	

Product Code - Pure White / Grey	HSN Code	Description	Type	No. of Modules	MRP (₹)	Std. Pkg. (Nos.)
Blanking Modules						
CG20056PWNR / CG23056NR	85381010	1 Gang	-	1	35	40
CG20073PWNR / CG23073NR	85381010	2 Gang	-	2	61	20

Product Code - Pure White / Grey	HSN Code	Description	Type	No. of Modules	MRP (₹)	Std. Pkg. (Nos.)
Neon Indicators						
CG20634PWNR / CG23634NR	85361010	Red Color	-	1	100	20

Fan Regulator / Dimmer						
Product Code - Pure White / Grey	HSN Code	Description	Type	No. of Modules	MRP (₹)	Std. Pkg. (Nos.)
Fan Regulator						
CG20826PWNR / CG23826NR	85361010	5 Step (100W)	Rotary	2	464	10
CG20827PWNR / CG23827NR	85361010	4 Step (100W)	Rotary	1	369	20

Product Code - Pure White / Grey	HSN Code	Description	Type	No. of Modules	MRP (₹)	Std. Pkg. (Nos.)
Dimmer						
CG20801PWNR / CG23801NR	85361010	500W	Rotary (Stepless)	2	461	10
CG20804PWNR / CG23804NR	85361010	300W	Rotary (Stepless)	1	407	20



Modular Switches | DIVINO



CG20370PWNR CG23370NR



CG20353PWNR CG23353NR



CG20251PWNR CG23251NR



CG20636PWNR



CG20275PWNR



CG20815PWNR



CG20609PWNR CG23609NR



CG20610PWNR CG23610NR



CG20611PWNR CG23611NR

Socket							
Product Code - Pure White / Grey	HSN Code	Description	For Plug Pin	No. of Modules	MRP (₹)	Std. Pkg. (Nos.)	
Sockets With Safety Shutters							
CG20370PWNR / CG23370NR	85361010	6A Socket 3 Pin (Flushed)	Round	2	144	10	
*CG20353PWNR / CG23353NR	85361010	6A Socket 5 Pin (Flushed)	Round	2	166	10	
CG20354PWNR / CG23354NR	85361020	6/16A Twin Socket 3 Pin (Flushed)	Round	3	277	6	
CG20352PWNR / CG23352NR	85361020	6/16A Twin Socket 3 Pin (Projected)	Round	2	263	10	
*CG20355PWNR / CG23355NR	85361020	25A-Socket (Flushed)	Round	3	289	6	
*CG20356PWNR / CG23356NR	85361020	25A-Socket (Projected)	Round	2	263	10	
*CG20359PWNR / CG23359NR	85361010	6A- 2 Pin Socket	Round	1	106	20	
Product Code - Pure White / Grey	HSN Code	Description	Nos. Pairs	For Plug Pin	No. of Modules	MRP (₹)	Std. Pkg. (Nos.)
Telephone / Computer / TV Socket							
CG20251PWNR / CG23251NR	85361010	RJ11	2	Twisted pair	1	121	20
CG20271PWNR / CG23271NR	85361010	RJ45 CAT5e	4	UTP		468	
CG20228PWNR / CG23228NR	85361010	TV Socket	-	-		114	
CG20272PWNR / CG23272NR	85361010	RJ45 CAT6	4	UTP		553	
CG20273PWNR / CG23273NR	85361010	RJ45 CAT6a		UTP	1216		

Buzzer						
CG20636PWNR / CG23636NR	85361010	Buzzer		1	560	20

USB Charger Socket					
Product Code - Pure White / Grey	HSN Code	Description	No. of Modules	MRP (₹)	Std. Pkg. (Nos.)
CG20275PWNR / CG23275NR	85044030	USB Charger Socket 2.1A (Fast Charging)	1	945	20

Hospitality Range					
Product Code - Pure White / Grey	HSN Code	Description	No. of Modules	MRP (₹)	Std. Pkg. (Nos.)
Energy Key Tag					
CG20815PWNR / CG23815NR	85361020	1P-25A, 230V-Energy Key Switch With Tag	2	608	1
CG20434PWNR / CG23434NR	85361010	Tag For Energy Key Tag	-	125	-
Application activation of functions service inside hotel rooms (e.g.m light, air-conditioner, minibar) when the room is occupied (with badge inserted)					
Do Not Disturb					
CG20609PWNR / CG23609NR	85361010	Indicator	1	110	20
CG20124PWNR / CG23124NR	85361010	6A-230V, IW, SP Luminous Switch		156	
CG20612PWNR / CG23612NR	85361010	Unit (Indicator+Switch)	1+1	261	10
Room Occupied					
CG20610PWNR / CG23610NR	85361010	Indicator	1	110	20
CG20125PWNR / CG23125NR	85361010	6A-230V, IW, SP Luminous Switch		156	
CG20613PWNR / CG23613NR	85361010	Unit (Indicator+Switch)	1+1	261	10
Make My Room					
CG20611PWNR / CG23611NR	85361010	Indicator	1	110	20
CG20126PWNR / CG23126NR	85361010	6A-230V, IW, SP Luminous Switch		156	
CG20614PWNR / CG23614NR	85361010	Unit (Indicator+Switch)	1+1	261	10

* Material available till stock last.



CG20825PWNR



CG20632NR



CG20436PWNR



CG20443PWNR



CG26401PWNR



CG20362PWNR



CG25703PWNR

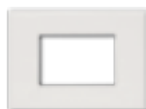

CG25803PWNR

Product Code - Pure White / Grey	HSN Code	Description	No. of Modules	MRP (₹)	Std. Pkg. (Nos.)
Time Delay Electronic Switch (Card Operated)					
CG20825PWNR / CG23825NR	85361020	25A	3	1356	6
Foot Lamp					
CG20631NR	94051090	230V-LED Yellow Night Lamp	3	379	6
CG20632NR	94051090	230V-LED Blue Night Lamp			
CG20633NR	94051090	230V-LED White Night Lamp			

Modular Miniature Case Circuit Breaker - WiNtrip 'S'					
Product Code - Pure White	HSN Code	Description	No. of Modules	MRP (₹)	Std. Pkg. (Nos.)
Single Pole					
CG20431PWNR	85361010	6A Single Pole 4.5kA - Tripping Curve 'C'	1	221	12
CG20432PWNR	85361010	10A Single Pole 4.5kA - Tripping Curve 'C'			
CG20433PWNR	85361020	16A Single Pole 4.5kA - Tripping Curve 'C'			
CG20437PWNR	85361020	20A Single Pole 4.5kA - Tripping Curve 'C'			
CG20435PWNR	85361020	25A Single Pole 4.5kA - Tripping Curve 'C'			
CG20436PWNR	85361020	32A Single Pole 4.5kA - Tripping Curve 'C'			
Double Pole					
CG20438PWNR	85361010	6A Double Pole 4.5kA - Tripping Curve 'C'	2	528	6
CG20439PWNR	85361010	10A Double Pole 4.5kA - Tripping Curve 'C'			
CG20440PWNR	85361020	16A Double Pole 4.5kA - Tripping Curve 'C'			
CG20441PWNR	85361020	20A Double Pole 4.5kA - Tripping Curve 'C'			
CG20442PWNR	85361020	25A Double Pole 4.5kA - Tripping Curve 'C'			
CG20443PWNR	85361020	32A Double Pole 4.5kA - Tripping Curve 'C'			

Power Unit				
Product Code - Pure White	HSN Code	Description	MRP (₹)	Std. Pkg. (Nos.)
CG26401PWNR	85371000	16Amp Power Unit	968	1
*CG26402PWNR	85371000	20Amp Power Unit	1126	
*CG26403PWNR	85371000	25Amp Power Unit	1126	
Power Unit with PVC				
CG26404PWNR	85371000	16Amp Power Unit	843	1
*CG26405PWNR	85371000	20Amp Power Unit	1121	
*CG26406PWNR	85371000	25Amp Power Unit	1121	

Single Phase Motor Starter					
Product Code - Pure White / Grey	HSN Code	Description	No. of Modules	MRP (₹)	Std. Pkg. (Nos.)
CG20362PWNR /CG23362NR	85361020	Motor Starter 16A	2	452	1
CG20364PWNR /CG23364NR	85361020	Motor Starter 25A	2	575	

Pure White Cover Plates With Support Plate				
Product Code - Vera / Virna	HSN Code	Description	MRP (₹)	Std. Pkg. (Nos.)
CG25701PWNR / CG25801PWNR	85381010	1 Module Plate	124	10
CG25702PWNR / CG25802PWNR	85381010	2 Module Plate		
CG25703PWNR / CG25803PWNR	85381010	3 Module Plate		
CG25704PWNR / CG25804PWNR	85381010	4 Module Plate		
CG25706PWNR / CG25806PWNR	85381010	6 Module Plate	264	5
CG25708PWNR / CG25808PWNR	85381010	8 Module Plate - Vertical		
CG25709PWNR / CG25809PWNR	85381010	8 Module Plate - Horizontal		
CG25712PWNR / CG25812PWNR	85381010	12 Module Plate		
CG25718PWNR / CG25818PWNR	85381010	18 Module Plate		

* Material available till stock last.



CG25803GRNR



CG25803BGNR



CG25803CORNR



CG25703BWNR



CG25803EWNR

Glossy Grey Cover Plates With Support Plate				
Product Code Vera / Virna	HSN Code	Description	MRP (₹)	Std. Pkg. (Nos.)
CG25701GRNR / CG25801GRNR	85381010	1 Module Plate	178	10
CG25702GRNR / CG25802GRNR	85381010	2 Module Plate		
CG25703GRNR / CG25803GRNR	85381010	3 Module Plate		
CG25704GRNR / CG25804GRNR	85381010	4 Module Plate		
CG25706GRNR / CG25806GRNR	85381010	6 Module Plate	383	5
CG25708GRNR / CG25808GRNR	85381010	8 Module Plate - Vertical		
CG25709GRNR / CG25809GRNR	85381010	8 Module Plate - Horizontal		
CG25712GRNR / CG25812GRNR	85381010	12 Module Top Plate		
CG25718GRNR / CG25818GRNR	85381010	18 Module Plate	800	

Cover Plates With Support Plate				
Product Code Vera / Virna	HSN Code	Description	MRP (₹)	Std. Pkg. (Nos.)
Cadet Grey / Black Olive / Argent Grey / Charcol Black / Arsenic Black / Champagne / Candy Red / Coral Red / British Green Plates				
CG25701NR / CG25801NR	85381010	1 Module Plate	267	10
CG25702NR / CG25802NR	85381010	2 Module Plate		
CG25703NR / CG25803NR	85381010	3 Module Plate	318	
CG25704NR / CG25804NR	85381010	4 Module Plate	398	
CG25706NR / CG25806NR	85381010	6 Module Plate	549	5
CG25708NR / CG25808NR	85381010	8 Module - Vertical	592	
CG25709NR / CG25809NR	85381010	8 Module - Horizontal		
CG25712NR / CG25812NR	85381010	12 Module Plate	755	
CG25718NR / CG25818NR	85381010	18 Module Plate	986	

Please add codes CG for Cadet Grey, BO for Black Olive, AG for Argent Grey, CB for Charcol Black, AB for Arsenic Black, CH for Champagne, CAR for Candy Red, COR for Coral Red, BG for British Green Plates e.g. for ordering one module Vera Cadet Grey plate code would be CG25701CG

English Walnut & Burly Wood Cover Plates With Support Plate				
Product Code Vera / Virna	HSN Code	Description	MRP (₹)	Std. Pkg. (Nos.)
CG25701NR / CG25801NR	85381010	1 Module Plate	334	10
CG25702NR / CG25802NR	85381010	2 Module Plate		
CG25703NR / CG25803NR	85381010	3 Module Plate		
CG25704NR / CG25804NR	85381010	4 Module Plate		
CG25706NR / CG25806NR	85381010	6 Module Plate	721	5
CG25708NR / CG25808NR	85381010	8 Module Plate - Vertical	743	
CG25709NR / CG25809NR	85381010	8 Module Plate - Horizontal		
CG25712NR / CG25812NR	85381010	12 Module Top Plate	970	
CG25718NR / CG25818NR	85381010	18 Module Plate	1104	

Please add codes EW for English Walnut and BW for Burly Wood e.g. for ordering one module Vera English Walnut plate code would be CG25701EW

Cover Plate Sizes (All dimensions in mm)

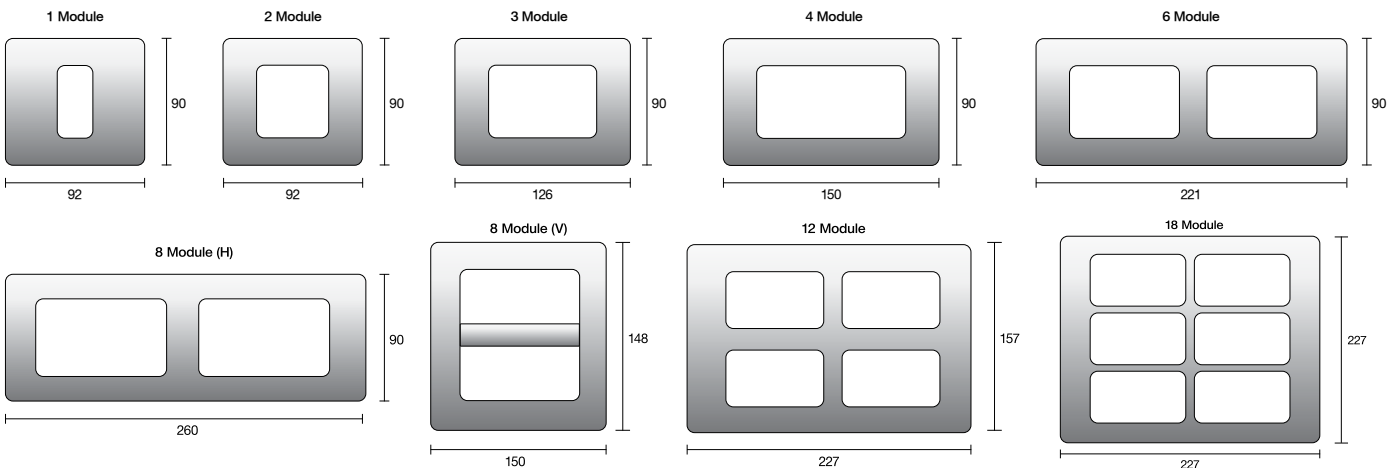



Weather Proof Enclosures COMBI



CG26000WNR CG26400WNR



CG24025WNR



CG26012WNR

IP55 Enclosures						
Product Code	HSN Code	Description	Configuration	MRP (₹)	Std. Pkg. (Nos.)	
Watertight And Dust Proof Enclosures IP55-Surface Mounting						
CG26000WNR	85371000	Bell Push	1 Module	706	1	
CG26400WNR	85371000	16A Switch, 6/16A Socket	3 Module	1202		
CG26016WNR	85371000	6A Switch	1 Module	652		
IP55 Motor Starter						
CG26018WNR	85381010	IP55 2M Enclosure With 16A Motor Starter		1176	1	
CG26019WNR	85381010	IP55 2M Enclosure With 25A Motor Starter		1382		
Watertight Plates For Flush Mounting Installations IP55 (Compatible with 3M concealed box)						
CG24025WNR	85381010	3 Gang		748	10	
Product Code	HSN Code	Description	Configuration	External Dim. LxHxD (mm)	MRP (₹)	Std. Pkg. (Nos.)
Watertight Enclosures For Fixed Or Movable Applications						
CG26010WNR	85381010	1 Gang	Module 1	80x64x59	505	10
CG26011WNR	85381010	2 Gang	Module 2	80x64x59	524	
CG26012WNR	85381010	3 Gang	Module 3	80x96x59	633	
CG26013WNR	85381010	4 Gang	Module 4x1	80x128x59	829	5
CG26014WNR	85381010	8 Gang	Module 4x2	160x128x59	1415	
CG26015WNR	85381010	12 Gang	Module 4x3	240x128x59	1865	3





CG28015NR



CG28017NR



CG28023NR



CG28020NR



ACBHS001NR ACBHA004NR



ACBHA005NR



ACBHS006NR



ACBHS008NR



ACCR001NR



Top Plug				
Product Code	HSN Code	Description	MRP (₹)	Std. Pkg. (Nos.)
CG28014NR	85361010	6A Plug Top	72	10
CG28015NR	85361020	16A Plug Top	107	
*CG28018NR	85361020	25 A Plug Top	138	

Top Plug with Indicator				
Product Code	HSN Code	Description	MRP (₹)	Std. Pkg. (Nos.)
CG28017NR	85361020	16A Plug Top	114	10
*CG28019NR	853 61010	25A Plug Top	168	

Two Pin Socket				
Product Code	HSN Code	Description	MRP (₹)	Std. Pkg. (Nos.)
*CG28021NR	853 61010	6A 2 Pin Plug Top - Male	26	30
*CG28023NR	853 61010	6A 2 Pin Plug Top Combined Unit (Male & Female)	54	

Multi Plug Socket				
Product Code	HSN Code	Description	MRP (₹)	Std. Pkg. (Nos.)
CG28020NR	85361010	6A Multi Plug Socket	97	10

Batten Holder				
Product Code	HSN Code	Description	MRP (₹)	Std. Pkg. (Nos.)
ACBHS001NR	85381010	Straight Batten Holder (Plain)	57	20
ACBHA003NR	85381010	Angular Batten Holder (Plain)		
ACBHS002NR	85381010	Straight Batten Holder (Fancy)	68	
ACBHA004NR	85381010	Angular Batten Holder (Fancy)		
ACBHA005NR	85381010	Batten Holder common (2 in 1)	79	
ACBHS006NR	85381010	Square Batten Holder (Plain)	90	
ACBHA007NR	85381010	Square angle Batten Holder (Plain)		
ACBHS008NR	85381010	Slim Batten Holder (Fancy)	99	
ACBHA009NR	85381010	Slim angle Batten Holder (Fancy)		
Ceiling Rose				
ACCR001NR	85381010	Ceiling rose	47	20

Surface Plastic Box				
Product Code	HSN Code	Description	MRP (₹)	Std. Pkg. (Nos.)
ACSMB001NR	85381010	1 Module	68	10
ACSMB001NR	85381010	2 Module	68	
ACSMB003NR	85381010	3 Module	88	
ACSMB004NR	85381010	4 Module	95	
ACSMB006NR	85381010	6 Module	128	
ACSMB008NR	85381010	8 Module (Horizontal)	176	
ACSMB009NR	85381010	8 Module (Vertical)	176	
ACSMB012NR	85381010	12 Module	223	
ACSMB018NR	85381010	18 Module	250	
				5

* Material available till stock last.

A Piece of **Art** with Complete
Safety, Comfort & Aesthetics
for your **Walls**



- Available in 1 Module to 18 Module*
- Sleek Design & Compatible with Primo Range of Switches
- Highly Aesthetic Break Free Design
- Compatible to Market Boxes
- Designed with Front Mount & Removal Option

* The Antibacterial feature are available only in White & Grey Top Plates & Accessories.



CS20114PNR



CS20123PNR



CS20511PNR



CS20056PNR



CS20631NR



CS20801PNR

Switches							
Product Code - Pure White / Grey	HSN Code	Description	Type	No. Modules	MRP (₹)	Std. Pkg. (Nos.)	
One-Way Switches							
CS20113PNR / CS23113PNR	85361010	6A, 250V	General	1	94	20	
CS20114PNR / CS23114PNR	85361010	6A, 250V	Luminous	1	122		
CS20115PNR / CS23115PNR	85361010	6A, 250V	Luminous	2	135	10	
CS20573PNR / CS23573PNR	85361020	16A, 250V	General	1	141	20	
CS20574PNR / CS23574PNR	85361020	16A, 250V	Luminous	1	177		
CS20575PNR / CS23575PNR	85361020	16A, 250V	Luminous	2	185	10	
CS20117PNR / CS23117PNR	85361020	25A, 250V	General	1	186	20	
CS20118PNR / CS23118PNR	85361020	25A, 250V	Luminous	1	220		
CS20119PNR / CS23119PNR	85361020	25A, 250V	General	2	222	10	
CS20120PNR / CS23120PNR	85361020	25A, 250V	Luminous	2	246		
Two-Way Switches							
CS20123PNR / CS23123PNR	85361010	6A, 250V	General	1	134	20	
CS20124PNR / CS23124PNR	85361010	6A, 250V	General	2	138	10	
CS20578PNR / CS23578PNR	85361020	16A, 250V	General	1	210	20	
CS20579PNR / CS23579PNR	85361020	16A, 250V	General	2	232	10	
Product Code - Pure White / Grey	HSN Code	Description	Type	No. Modules	MRP (₹)	Std. Pkg. (Nos.)	
Bell Push Switches							
CS20509PNR / CS23509PNR	85361010	6A, Bell Push	General	1	130	20	
CS20508PNR / CS23508PNR	85361010	6A, Bell Push	Luminous	1	150		
CS20510PNR / CS23510PNR	85361010	6A, Bell Push	General	2	144	10	
CS20511PNR / CS23511PNR	85361010	6A, Bell Push	Luminous	2	151		
Blanking Module							
CS20056PNR / CS23056PNR	85381010	1M Blank	General	1	34	50	
Product Code - Pure White / Grey	HSN Code	Description	No. Modules	MRP (₹)	Std. Pkg. (Nos.)		
Neon Indicator							
CS20631PNR / CS23631PNR	85361010	Neon Indicator Red	1	79	20		
Product Code - Pure White / Grey	HSN Code	Description	No. Modules	MRP (₹)	Std. Pkg. (Nos.)		
Fan Regulator / Dimmer							
CS20826PNR / CS23826PNR	85361010	5-Step Fan Regulator 100W	2	417	10		
CS20828PNR / CS23828PNR	85361010	5 Step Fan Regulator 120 W	2	480	10		
CS20827PNR / CS23827PNR	85361010	4-Step Fan Regulator 100W	1	335	20		
CS20801PNR / CS23801PNR	85361010	Rotary Type Dimmer 500W	2	446	10		
CS20804PNR / CS23804PNR	85361010	Rotary Type Dimmer 300W	1	327	20		

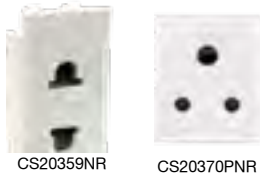

Product Code - Pure White / Grey	HSN Code	Description	No. Modules	MRP (₹)	Std. Pkg. (Nos.)
Sockets with Safety Shutters					
*CS20359PNR / CS23359PNR	85361010	6A, 2 Pin Socket	1	100	20
CS20370PNR / CS23370PNR	85361010	6A, 3 Pin	2	122	10
*CS20353PNR / CS23353PNR	85361010	6A, 5 Pin	2	141	
CS20352PNR / CS23352PNR	85361020	6/16A, 6 Pin	3	226	
CS20354PNR / CS23354PNR	85361020	6/16A, Socket Projected	2	212	
*CS20355PNR / CS23355PNR	853 61020	6/25 A, 6 Pin	3	261	
*CS20356PNR / CS23356PNR	853 61020	6/16/25 A, 6 Pin Socket Projected	2	212	
*CS20358PNR / CS23358PNR	853 61020	13A Universal Socket	2	232	



CS20636PNR

Buzzer					
Product Code	HSN Code	Description	No. of Modules	MRP (₹)	Std. Pkg. (Nos.)
CS20636PNR / CS23636PNR	85044030	Buzzer	1	550	20



CS20228PNR

Product Code - Pure White / Grey	HSN Code	Description	No. Modules	MRP (₹)	Std. Pkg. (Nos.)
TV Socket / Flex Outlet					
CS20228PNR / CS23228PNR	85361010	TV Socket	1	110	20
CS20237PNR / CS23237PNR	85361010	Flex Outlet	1	77	



CS20251PNR

Product Code - Pure White / Grey	HSN Code	Description	No. Modules	MRP (₹)	Std. Pkg. (Nos.)
Telephone / Computer Socket					
CS20251PNR / CS23251PNR	85361010	RJ 11, Telephone Jack	1	110	20
CS20271PNR / CS23271PNR	85361010	RJ 45, Computer Jack CAT5e	1	349	
CS20272PNR / CS23272PNR	85361010	RJ 45, Computer Jack CAT6	1	541	
CS20273PNR / CS23273PNR	85361010	RJ 45, Computer Jack CAT6a	1	1035	



CS20275PNR

USB Charger Socket					
Product Code - Pure White / Grey	HSN Code	Description	No. of Modules	MRP (₹)	Std. Pkg. (Nos.)
CS20275PNR / CS23275PNR	85044030	USB Charger Socket 2.1A (Fast Charging)	1	935	20



CS20816PNR

Hospitality Range					
Product Code - Pure White / Grey	HSN Code	Description	No. of Modules	MRP (₹)	Std. Pkg. (Nos.)
Energy Saving Switch					
CS20816PNR / CS23816PNR	85361020	25A, Energy Saving Switch With Key Tag & Indicator	2	497	1

APPLICATION: activation of functions and service inside hotel rooms (e.g. light, air-conditioner, minibar) when the room is occupied (with badge inserted).



CS20611PNR CS20610PNR

DND/MMR Switch Units					
Product Code	HSN Code	Description	No. of Modules	MRP (₹)	Std. Pkg. (Nos.)
CS20610PNR / CS23610PNR	85361010	DND/MMR External Unit	1	235	20
CS20611PNR / CS23611PNR	85361010	DND/MMR Internal Unit	1+1	228	10
CS20609PNR / CS23609PNR	85361010	Indicator	1	100	20



CS20632PNR CS20633PNR

Skirt Light & Night Lamp					
Product Code	HSN Code	Description	No. of Modules	MRP (₹)	Std. Pkg. (Nos.)
CS20632PNR / CS23632PNR	94051090	Skirt Light	2	372	10
CS20633PNR / CS23633PNR	94051090	Night Lamp	2	390	10



Primo Plus Power Unit with PVC					
Product Code - Pure White	HSN Code	Description	No. of Modules	MRP (₹)	Std. Pkg. (Nos.)
CS26404PWNR	85371000	Power Unit Combo 16A MCB Protected Socket	4	796	1
*CS26405PWNR	85371000	Power Unit Combo 20A MCB Protected Socket	4	991	
*CS26406PWNR	85371000	Power Unit Combo 25A MCB Protected Socket	4	991	
CS26408PWNR	85371000	Power Unit Combo Heavy Duty with 25Amp MCB	4	1121	
Primo Plus Power Unit with Metal Enclosure					
CS26401PNR	85371000	Power Unit Combo 16A MCB	4	968	1
CS26407PWNR	85371000	Power Unit Combo Heavy Duty with 25Amp MCB	4	1126	



CS26404PWNR



CS25803WHNR



CS25803GRNR

Product Code	HSN Code	Description	MRP (₹)	Std. Pkg. (Nos.)
Swan White (Cover Plates with Support Plate)				
CS25801WHNR	85381010	1 Module Plate	96	10
CS25802WHNR	85381010	2 Module Plate		
CS25803WHNR	85381010	3 Module Plate	134	
CS25804WHNR	85381010	4 Module Plate	140	
CS25806WHNR	85381010	6 Module Plate	204	
CS25808WHNR	85381010	8 Module Plate (Horizontal)	256	
CS25809WHNR	85381010	8 Module Plate (Vertical)		
CS25812WHNR	85381010	12 Module Plate	345	5
CS25816WHNR	85381010	16 Module Plate	399	
CS25818WHNR	85381010	18 Module Plate	423	
Glossy Grey (Cover Plates with Support Plate)				
CS25801GRNR	85381010	1 Module Plate	101	10
CS25802GRNR	85381010	2 Module Plate		
CS25803GRNR	85381010	3 Module Plate	130	
CS25804GRNR	85381010	4 Module Plate	145	
CS25806GRNR	85381010	6 Module Plate	208	
CS25808GRNR	85381010	8 Module Plate (Horizontal)	265	
CS25809GRNR	85381010	8 Module Plate (Vertical)		
CS25812GRNR	85381010	12 Module Plate	350	5
CS25816GRNR	85381010	16 Module Plate	432	
CS25818GRNR	85381010	18 Module Plate	460	

Cover Plates with Support Plate				
Product Code	HSN Code	Description	MRP (₹)	Std. Pkg. (Nos.)
Cadet Grey / Black Olive / Argent Grey / Charcol Black / Arsenic Black / Champagne / Candy Red / Corel Red / British Green Plates				
CS25801NR	85381010	1 Module Plate	197	10
CS25802NR	85381010	2 Module Plate		
CS25803NR	85381010	3 Module Plate	233	
CS25804NR	85381010	4 Module Plate	261	5
CS25806NR	85381010	6 Module Plate	394	
CS25808NR	85381010	8 Module - Horizontal	441	
CS25809NR	85381010	8 Module - Vertical		
CS25812NR	85381010	12 Module Plate	571	
CS25816NR	85381010	16 Module Plate	610	
CS25818NR	85381010	18 Module Plate	739	
Please add codes CS for Cadet Grey, BO for Black Olive, AG for Argent Grey, CB for Charcol Black, AB for Arsenic Black, CH for Champagne, CAR for Candy Red, COR for Corel Red, BG for British Green Plates e.g. for ordering one module Cadet Grey plate code would be CS25801				



* Material available till stock last.



CS25803BWNR



CS25803EWNR

English Walnut & Burly Wood Cover Plates with Support Plate

Product Code	HSN Code	Description	MRP (₹)	Std. Pkg. (Nos.)
CS25801NR	85381010	1 Module Plate	258	10
CS25802NR	85381010	2 Module Plate		
CS25803NR	85381010	3 Module Plate	282	
CS25804NR	85381010	4 Module Plate	297	5
CS25806NR	85381010	6 Module Plate	508	
CS25808NR	85381010	8 Module Plate - Horizontal		
CS25809NR	85381010	8 Module Plate - Vertical	586	
CS25812NR	85381010	12 Module Top Plate	759	
CS25816NR	85381010	16 Module Top Plate	847	
CS25818NR	85381010	18 Module Plate	901	

Please add codes EW for English Walnut and BW for Burly Wood e.g. for ordering one module English Walnut plate code would be CS25801EW

Metal Boxes- Fabricated (Box for DIVINO, PRIMO PLUS & PRIMO)

Product Code	HSN Code	Description	Dimension LxHxD (mm)	MRP (₹)	Std. Pkg. (Nos.)
CG24271NR	85381010	1 Module Box	75 X 75 X 50	83	10
CG24271NR	85381010	2 Module Box	75 X 75 X 50		
CG24272NR	85381010	3 Module Box	100 X 75 X 50	98	
CG24273NR	85381010	4 Module Box	135 X 76 X 50	120	5
CG24274NR	85381010	6 Module Box	210 X 75 X 50	169	
CG24275NR	85381010	8 Module Box (4 +4)	134 X 140 X 52	196	
CG24276NR	85381010	8 Module Box (Horizontal)	232 X 79 X 52		
CG24277NR	85381010	12 Module Box	210 X 140 X 50	240	
CG24279NR	85381010	16 Module Box	210 X 140 X 60	302	
CG24278NR	85381010	18 Module Box	210 X 210 X 56	339	5

* 10M Top Plate shall be fitted in 8M (4+4) Vertical Metal Box (i.e. CG 24 275)
 * 5M Top Plate Shall be fitted in 4M Metal Box (i.e. CG 24 273)
 * Deep Drawn Metal Boxes are available on request.



CG24272NR



Modular Switches | PRIMO



CS20114NR



CS20123NR



CS20511NR

CS20056NR



CS20631NR



CS20801NR



CS20359NR

CS20370NR



CS20228NR



CS20251NR

Switches						
Product Code - Pure White	HSN Code	Description	Type	No. Modules	MRP (₹)	Std. Pkg. (Nos.)
One-Way Switches						
CS20113NR	85361010	6A, 250V	General	1	80	20
CS20114NR	85361010	6A, 250V	Luminous	1	112	
CS20115NR	85361010	6A, 250V	Luminous	2	125	10
CS20573NR	85361020	16A, 250V	General	1	131	20
CS20574NR	85361020	16A, 250V	Luminous	1	162	
CS20575NR	85361020	16A, 250V	Luminous	2	172	10
CS20117NR	85361020	25A, 250V	General	1	173	20
CS20118NR	85361020	25A, 250V	Luminous	1	205	
CS20119NR	85361020	25A, 250V	General	2	205	10
CS20120NR	85361020	25A, 250V	Luminous	2	229	
Two-Way Switches						
CS20123NR	85361010	6A, 250V	General	1	127	20
CS20124NR	85361010	6A, 250V	General	2	131	10
CS20578NR	85361020	16A, 250V	General	1	181	20
CS20579NR	85361020	16A, 250V	General	2	185	10
Product Code - Pure White	HSN Code	Description	Type	No. Modules	MRP (₹)	Std. Pkg. (Nos.)
Bell Push Switches						
CS20509NR	85361010	6A, Bell Push	General	1	108	20
CS20508NR	85361010	6A, Bell Push	Luminous	1	126	
CS20510NR	85361010	6A, Bell Push	General	2	134	10
CS20511NR	85361010	6A, Bell Push	Luminous	2	141	
Blanking Module						
CS20056NR	85381010	1M Blank	General	1	29	50
Product Code - Pure White	HSN Code	Description	Type	No. Modules	MRP (₹)	Std. Pkg. (Nos.)
Neon Indicator						
CS20631NR	85361010	Neon Indicator Red		1	74	20
Product Code - Pure White	HSN Code	Description	Type	No. Modules	MRP (₹)	Std. Pkg. (Nos.)
Fan Regulator / Dimmer						
CS20826NR	85361010	5-Step Fan Regulator 100W		2	405	10
CS20828NR	85361010	5 Step Fan Regulator 120 W		2	465	10
CS20827NR	85361010	4-Step Fan Regulator 100W		1	314	20
CS20801NR	85361010	Rotary Type Dimmer 500W		2	410	10
CS20804NR	85361010	Rotary Type Dimmer 300W		1	310	20
Sockets with Safety Shutters						
*CS20359NR	85361010	6A, 2 Pin Socket		1	94	20
CS20370NR	85361010	6A, 3 Pin		2	110	
*CS20353NR	85361010	6A, 5 Pin		2	129	
CS20352NR	85361020	6/16A, 6 Pin		3	218	
CS20354NR	85361020	6/16A, Socket Projected		2	202	
*CS20355NR	85361020	6/25A, 6 Pin		3	250	
*CS20356NR	85361020	6/16/25A, 6 Pin Socket Projected		2	202	
*CS20358NR	85361020	13A Universal Socket		2	228	
Product Code - Pure White	HSN Code	Description	Type	No. Modules	MRP (₹)	Std. Pkg. (Nos.)
TV Socket / Flex Outlet						
CS20228NR	85361010	TV Socket		1	103	20
CS20237NR	85361010	Flex Outlet		1	65	
Product Code - Pure White	HSN Code	Description	Type	No. Modules	MRP (₹)	Std. Pkg. (Nos.)
Telephone / Computer Socket						
CS20251NR	85361010	RJ 11, Telephone Jack		1	103	20
CS20271NR	85361010	RJ 45, Computer Jack CAT5e		1	332	
CS20272NR	85361010	RJ 45, Computer Jack CAT6		1	513	
CS20273NR	85361010	RJ 45, Computer Jack CAT6a		1	985	

* Material available till stock last.



CS20636NR

Buzzer					
Product Code	HSN Code	Description	No. of Modules	MRP (₹)	Std. Pkg. (Nos.)
CS20636NR	85044030	Buzzer	1	540	20



CS20275NR

USB Charger Socket					
Product Code - Pure White	HSN Code	Description	No. of Modules	MRP (₹)	Std. Pkg. (Nos.)
CS20275NR	85044030	USB Charger Socket 2.1A (Fast Charging)	1	919	20



CS20815NR

Hospitality Range					
Product Code - Pure White	HSN Code	Description	No. of Modules	MRP (₹)	Std. Pkg. (Nos.)
Energy Saving Switch					
CS20815NR	85361020	25A, Energy Saving Switch With Key Tag & Indicator	2	480	1

APPLICATION: activation of functions and service inside hotel rooms (e.g. light, air-conditioner, minibar) when the room is occupied (with badge inserted).



CS20611NR CS20610NR

DND/MMR Switch Units					
Product Code	HSN Code	Description	No. of Modules	MRP (₹)	Std. Pkg. (Nos.)
CS20610NR	85361010	DND/MMR External Unit	1+1	221	20
CS20611NR	85361010	DND/MMR Internal Unit	1+1	210	10
CS20609NR	85361010	Indicator	1	90	20



CS20632NR CS20633NR

Skirt Light & Night Lamp					
Product Code	HSN Code	Description	No. of Modules	MRP (₹)	Std. Pkg. (Nos.)
CS20632NR	94051090	Skirt Light	2	358	10
CS20633NR	94051090	Night Lamp	2	375	10



CS20431NR CS20443NR

Modular Miniature Case Circuit Breaker - WiNtrip 'S'					
Product Code - Pure White	HSN Code	Description	No. of Modules	MRP (₹)	Std. Pkg. (Nos.)
Single & Double Pole					
CS20431NR	85361010	6A Single Pole 4.5kA - Tripping Curve 'C'	1	221	12
CS20432NR	85361010	10A Single Pole 4.5kA - Tripping Curve 'C'			
CS20433NR	85361020	16A Single Pole 4.5kA - Tripping Curve 'C'			
CS20437NR	85361020	20A Single Pole 4.5kA - Tripping Curve 'C'			
CS20435NR	85361020	25A Single Pole 4.5kA - Tripping Curve 'C'			
CS20436NR	85361020	32A Single Pole 4.5kA - Tripping Curve 'C'			
CS20438NR	85361010	6A Double Pole 4.5kA - Tripping Curve 'C'	2	528	6
CS20439NR	85361010	10A Double Pole 4.5kA - Tripping Curve 'C'			
CS20440NR	85361020	16A Double Pole 4.5kA - Tripping Curve 'C'			
CS20441NR	85361020	20A Double Pole 4.5kA - Tripping Curve 'C'			
CS20442NR	85361020	25A Double Pole 4.5kA - Tripping Curve 'C'			
CS20443NR	85361020	32A Double Pole 4.5kA - Tripping Curve 'C'			



CS26401WNR

Power Unit					
Product Code - Pure White	HSN Code	Description	No. of Modules	MRP (₹)	Std. Pkg. (Nos.)
CS26401WNR	85371000	Power Unit Combo 16A MCB Protected Socket	4	797	1
*CS26402WNR	85371000	Power Unit Combo 20A MCB Protected Socket	4	917	
*CS26403WNR	85371000	Power Unit Combo 25A MCB Protected Socket	4	917	



CS20364NR

Single Phase Motor Starter					
Product Code	HSN Code	Description	MRP (₹)	Std. Pkg. (Nos.)	
CS20364NR	85361020	Motor Starter 16A	593	10	
CS20366NR	85361020	Motor Starter 25A			



Top Plates with Support Plate				
Product Code - Pure White	HSN Code	Description	MRP (₹)	Std. Pkg. (Nos.)
CS25701WHNR	85381010	1 Module Plate	83	10
CS25702WHNR	85381010	2 Module Plate		
CS25703WHNR	85381010	3 Module Plate	129	
CS25704WHNR	85381010	4 Module Plate	135	
CS25705WHNR	85381010	5 Module Plate (Compatible with 4M Metal Box)		
CS25706WHNR	85381010	6 Module Plate	183	
CS25707WHNR	85381010	8 Module Horizontal	242	
CS25709WHNR	85381010	8 Module Plate Horizontal (Compatible with 6M Metal Box)		
CS25710WHNR	85381010	10 Module-Vertical (Compatible With 8M (4+4) Metal Box)		
CS25711WHNR	85381010	10 Module-Horizontal (Compatible With 8M (H) Metal Box)		
CS25712WHNR	85381010	12 Module Plate	304	5
CS25716WHNR	85381010	16 Module Plate (Compatible With 12M Metal Box)	385	
CS25718WHNR	85381010	18 Module Plate	396	
Red / Yellow/ Green/ Blue / Grey Plates				
CS25701NR	85381010	1 Module Plate	93	10
CS25702NR	85381010	2 Module Plate	136	
CS25703NR	85381010	3 Module Plate		
CS25704NR	85381010	4 Module Plate	141	
CS25705NR	85381010	5 Module Plate (Compatible With 4M Metal Box)	191	
CS25706NR	85381010	6 Module Plate		
CS25707NR	85381010	8 Module Horizontal	245	
CS25709NR	85381010	8 Module Plate Horizontal (Compatible with 6M Metal Box)		
CS25710NR	85381010	10 Module-Vertical (Compatible With 8M (4+4) Metal Box)		
CS25711NR	85381010	10 Module-Horizontal (Compatible With 8M (H) Metal Box)		
CS25712NR	85381010	12 Module Plate	328	5
CS25716NR	85381010	16 Module Plate (Compatible With 12M Metal Box)	399	
CS25718NR	85381010	18 Module Plate	458	
Please add following to codes for color selection GR for Grey / RD for RED / YL for Yellow / BL for Blue/ GN for Green e.g. for ordering one module red plate code would be CS25701RD				
Wooden				
CS25701WNNR	85381010	1 Module Plate	178	10
CS25702WNNR	85381010	2 Module Plate	226	
CS25703WNNR	85381010	3 Module Plate		
CS25704WNNR	85381010	4 Module Plate	245	
CS25705WNNR	85381010	5 Module Plate (Compatible With 4M Metal Box)	313	
CS25706WNNR	85381010	6 Module Plate		
CS25707WNNR	85381010	8 Module Horizontal	450	
CS25709WNNR	85381010	8 Module Plate Horizontal (Compatible with 6M Metal Box)		
CS25710WNNR	85381010	10 Module-Vertical (Compatible With 8M (4+4) Metal Box)		
CS25711WNNR	85381010	10 Module-Horizontal (Compatible With 8M (H) Metal Box)		
CS25712WNNR	85381010	12 Module Plate	553	5
CS25716WNNR	85381010	16 Module Plate (Compatible With 12M Metal Box)	586	
CS25718WNNR	85381010	18Module Plate	695	



Cover Plate Sizes (All dimensions in mm)

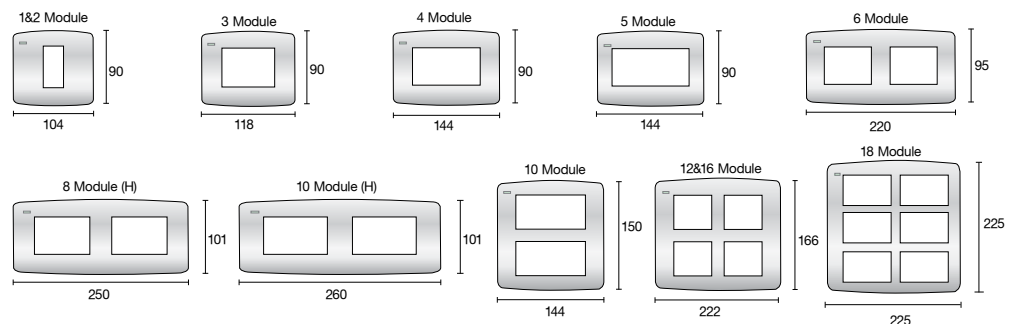

WiNtrip 'S'

Single Lock Modular MCB

The perfect solution for AC's, Refrigerators & Electrical Appliances

Safe | Convenient | Energy Saving | Wide Range
Compact Design | Overload & Short Circuit Protection
Rapid Closing Mechanism | Easy to Operate



CS20431RNR



CS20443RNR



CS20436NR

CS20438NR

Product Code	HSN Code	Description	No. of Modules	MRP (₹)	Std. Pkg. (Nos.)
Single Pole - Tripping Curve 'C'					
CG20431RNR	85361010	6A Single Pole 4.5kA-Tripping Curve 'C'	1	221	12
CG20432RNR	85361010	10A Single Pole 4.5kA-Tripping Curve 'C'			
CG20433RNR	85361020	16A Single Pole 4.5kA-Tripping Curve 'C'			
CG20437RNR	85361020	20A Single Pole 4.5kA-Tripping Curve 'C'			
CG20435RNR	85361020	25A Single Pole 4.5kA-Tripping Curve 'C'			
CG20436RNR	85361020	32A Single Pole 4.5kA-Tripping Curve 'C'			
Double Pole - Tripping Curve 'C'					
CG20438RNR	85361010	6A Double Pole 4.5kA-Tripping Curve 'C'	2	528	6
CG20439RNR	85361010	10A Double Pole 4.5kA-Tripping Curve 'C'			
CG20440RNR	85361020	16A Double Pole 4.5kA-Tripping Curve 'C'			
CG20441RNR	85361020	20A Double Pole 4.5kA-Tripping Curve 'C'			
CG20442RNR	85361020	25A Double Pole 4.5kA-Tripping Curve 'C'			
CG20443RNR	85361020	32A Double Pole 4.5kA-Tripping Curve 'C'			

Non-Modular Miniature Case Circuit Breaker - WiNtrip 'S'					
Product Code - Pure White	HSN Code	Description	No. of Modules	MRP (₹)	Std. Pkg. (Nos.)
Single & Double Pole					
CS20431NNR	85361010	6A Single Pole 4.5kA-Tripping Curve 'C'	1	221	12
CS20432NNR	85361010	10A Single Pole 4.5kA-Tripping Curve 'C'			
CS20433NNR	85361020	16A Single Pole 4.5kA-Tripping Curve 'C'			
CS20437NNR	85361020	20A Single Pole 4.5kA-Tripping Curve 'C'			
CS20435NNR	85361020	25A Single Pole 4.5kA-Tripping Curve 'C'			
CS20436NNR	85361020	32A Single Pole 4.5kA-Tripping Curve 'C'			
CS20438NNR	85361010	6A Double Pole 4.5kA-Tripping Curve 'C'	2	528	6
CS20439NNR	85361010	10A Double Pole 4.5kA-Tripping Curve 'C'			
CS20440NNR	85361020	16A Double Pole 4.5kA-Tripping Curve 'C'			
CS20441NNR	85361020	20A Double Pole 4.5kA-Tripping Curve 'C'			
CS20442NNR	85361020	25A Double Pole 4.5kA-Tripping Curve 'C'			
CS20443NNR	85361020	32A Double Pole 4.5kA-Tripping Curve 'C'			

Wiring Accessories

General Terms & Conditions

Price are subject to revision without prior notice and will be applicable as prevailing at the time of dispatch.

- This Pricelist supercedes all previous Price Lists.
- Maximum Retail Price (MRP) mentioned are maximum recommended selling prices inclusive of GST.
- All Prices are in Indian Rupees.

Warranty

All our listed Electro-mechanical wiring devices carry a warranty, against manufacturing defects for a period of 10 years from the date of invoicing & 2 years for all mains related electronic wiring products viz. Dimmers, Step Fan regulator and Indicators subject to it's usages in normal recommended operating conditions. Guarantee does not include Metal Box, Plug Tops and other stand alone products. The guarantee defines the company's entire liability & does not cover consequences loss or damage or reinstallations cost arising from defective product. The company liability shall be limited to exchange or repair of the product, at our discretion, provided that such defective products are returned to nearest Branch office.





24x7

SERVICE DESK

CENTRAL CUSTOMER CARE (CCC)

C&S Electric is committed to create a unique alchemy of outstanding products, operational excellence, path breaking customer services & compelling marketing. Further to enhance the post sales customer service experience, C&S introduces a service monitoring software "Salesforce". The software provides a transparent service tracking system and helps in efficient monitoring and quick resolution of queries.



Key Features & Benefits

- Transparent process
- Efficient monitoring & tracking of each Service Request
- Quick resolution time
- All relevant customer data in one single location
- Improved customer relationships
- Strengthen C&S brand image & reputation in the market

Escalation Matrix

*C&S Branch Service Engineer " ≥ 24 Hours"

Central Customer Care (CCC) " ≥ 48 Hours"
(Connect via Toll free no., Email ID, & Whatsapp no.)

GM Services - Mr. Bikram Rana " ≥ 72 Hours"
WhatsApp No.: 95994 45253, Email: bikram.rana@cselectric.co.in

Sr.VP - Mr. P. Anandan " ≥ 96 Hours"
Email: anandan.p@cselectric.co.in



FOR QUICK SUPPORT

Toll Free Number: 1800 572 2012 

WhatsApp No.: 95994 45253 

Email: customercare@cselectric.co.in



HOUSE OF INDUSTRIAL AUTOMATION & SWITCHGEAR

AUTOMATION BRAND



SWITCHGEAR BRAND

